

# Fiyat Listesi / Şubat 2021

Let's connect.

Türkiye'de  
30  
. yıl



**Weidmüller** 

## Weidmüller Fiyat Listesi / Şubat 2021

İçindekiler ve Önsöz	A + B	İçindekiler
W Serisi Ray Klemensleri ve Aksesuarları - Vida Bağlantı Teknolojisi	1 - 10	Klemens ve Aksesuarları
Bara-Ekranlama -Cihaz Sıra Ve Panel Klemensleri	11	
WMF Serisi Marshalling Ray Klemensleri - Vida Bağlantı Teknolojisi	12	
Z Serisi Ray Klemensleri - Yaylı Bağlantı Teknolojisi	13 - 17	
Klippon Connect PUSH IN Klemens Serisi	18 - 23	
Soketli Klemens Çözümleri	24 - 27	
Güç ve Sinyal Dağıtım Çözümleri	28 - 32	
Markalama	33 - 47	Markalama   PCB Fiş Soket   EI Aletleri
PCB - Baskılı Devre Klemensleri	48 - 50	
Rockstar Sanayi Tipi Fiş- Soket	51 - 56	
EI Aletleri	57 - 64	
Kutular	65 - 68	Kutu   Yüksük   Papuç   SKP   Kanal   Ray   Spiral   Kablo Bağı
Yüksükler ve Papuçlar	69 - 72	
Kablo Kanalları - Ray ve Aksesuarları - Spiral Hortum - Rakorlar ve LED Aydınlatma	73 - 74	
Kablo Bağları	75 - 76	
Frontcom® Vario & LED Aydınlatma	77 - 78	
u-mation Otomasyon Ürünleri	79 - 86	u-mation   SAI   Endüstriyel Ethernet
SAI - Sensör Aktuatör Arayüzleri	87 - 91	
Endüstriyel Ethernet	92 - 98	
Röleler ve Optokuplörler	99 - 111	Röleler ve Optokuplörler   Analog Sinyal Dönüştürücü
Analog Sinyal Dönüştürücüler	112 - 118	
Enerji Analizörleri	119 - 120	Enerji Analizörleri   Güç Kaynağı   Parafıdr   PV Sistemler
Güç Kaynakları	121 - 126	
Aşırı Gerilim Koruma Modülleri	127 - 130	
PV Sistemler için Ürünler ve Çözümler	131 - 133	
Sıralı Liste	134 - 148	Ürün Sıralı Listesi
Yetkili Bayilerimiz ve Otomasyon Partnerlerimiz	149	

## Şirket Profili

Weidmüller, elektriksel bağlantılar, sinyal, veri, güç dağıtım ve işlenmesi konularında endüstriyel ortamlarda sunduğu çözümler ile sektöründe lider konuma sahip global bir firmadır.

Firmamız, genel merkezinin de bulunduğu Almanya / Detmold yerleşkesi ve üç kıtaya yayılan diğer fabrikalarında araştırma, geliştirme ve üretim faaliyetlerini yürütmekte olup, ürettiği elektronik ve elektriksel bağlantı ürünlerinin tüm dünya geneline satışını gerçekleştirmektedir. Bunun yanı sıra Weidmüller uzmanlardan oluşturduğu teknik ağ yapısı ile uygulamaya özel çözümler üreten mühendislik hizmetlerini de müşterilerine sunmaktadır.

Komple ürün ve hizmet portföyüyle toplam çözüm tedarikçisi olmayı amaçlayan Weidmüller, zengin ürün ve hizmetleriyle müşterilerin rekabetçi avantajlar kazanmalarını ve faaliyetlerine değer katmalarını sağlar.

Weidmüller, dünya genelinde 80'den fazla ülkede faaliyet gösteren üretim tesisleri, satış ofisleri ve temsilcilikleri ile müşterilerine hizmet vermektedir.

### W Serisi Ray Klemensleri - Vida Bağlantı Teknolojisi

Weidmüller'in W serisi olan vida bağlantılı ray klemensleri uzun bir zamandan beri standartları belirlemektedir. Detaylarına kadar mükemmelleştirilmiş bir çok üstün özellikleri bu seriye zirvede bir pozisyonu garanti eder.

W serisi 0.06'dan 300 mm<sup>2</sup>'ye iletkenler için tüm genel elektrik uygulamalarına uygun bağlantı çözümü sunmaktadır.

W serisinin diğer bir avantajı da vidalı WQV serisi üst köprülerin yanında ZQV serisi vidasız üst köprülerde kullanılabilmesidir.

- ZQV serisi vidasız köprü kullanılması ile diğer vida bağlantılı klemensler ile karşılaştırıldığında önemli ölçüde zamandan kazanç sağlar.
- ZQV serisi vidasız köprüler 2.5 ve 4 mm<sup>2</sup> klemensler için 10 kutup'a kadar standarttır.
- 50 Kutuplu olarak tercih edilerek istenilen kutup sayısında kesilerek kullanılabilir.

Weidmüller'in patentli tasarımı sayesinde W serisi klemenslere aynı çapta iki iletken kolaylıkla bağlanabilir.

### W Serisi Şu Klemens Tiplerini Kapsar ;

- **WDU** - Geçiş Klemensleri
- **WPE** - Topraklama Klemensleri
- **WNT** - Nötr Klemensleri
- **WDL** - Üç İletkenli Dağıtım Klemensleri
- **WTR** - Ölçme Ayırma Klemensleri
- **WSI** - Sigortalı Klemensler
- **WDK** - Çok Katlı Klemensler

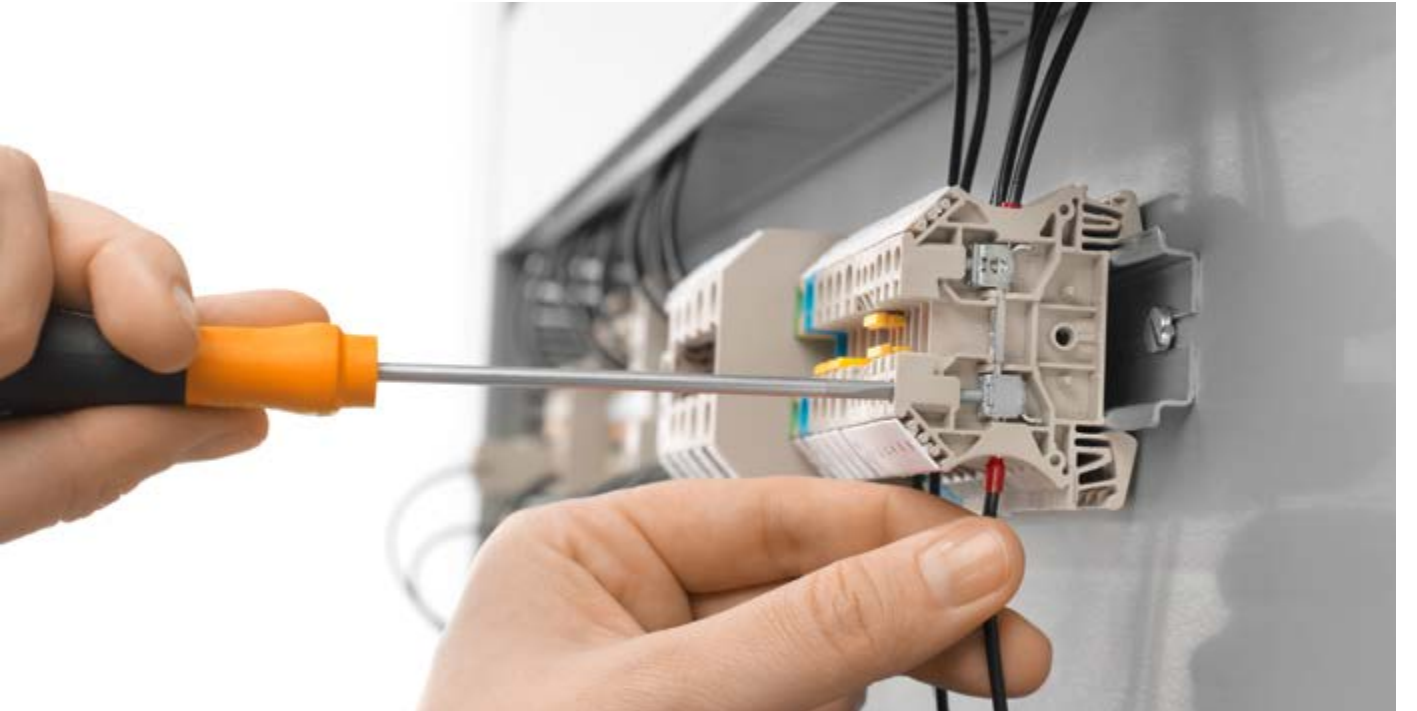

## W Serisi Ray Klemensleri - Vida Bağlantı Teknolojisi

Tip	V / A	Kesit - mm <sup>2</sup> (Yüksüksüz)	Sipariş No	Fiyat/Birim	Ambalaj
<b>Geçiş Klemensleri</b>					
WDU 2.5	800 / 24	0.05 - 4 mm <sup>2</sup>	102000000	5,38 TL	100
WDU 2.5 BL	800 / 24	0.05 - 4 mm <sup>2</sup>	102008000	5,38 TL	100
WDU 4	800 / 32	0.5 - 6 mm <sup>2</sup>	102010000	6,72 TL	100
WDU 4 BL	800 / 32	0.5 - 6 mm <sup>2</sup>	102018000	6,72 TL	100
WDU 6	800 / 41	0.5 - 10 mm <sup>2</sup>	102020000	11,35 TL	100
WDU 6 BL	800 / 41	0.5 - 10 mm <sup>2</sup>	102028000	11,35 TL	100
WDU 10	1000 / 57	1.5 - 16 mm <sup>2</sup>	102030000	15,45 TL	50
WDU 10 BL	1000 / 57	1.5 - 16 mm <sup>2</sup>	102038000	15,45 TL	50
WDU 16	1000 / 76	1.5 - 25 mm <sup>2</sup>	102040000	20,85 TL	50
WDU 16 BL	1000 / 76	1.5 - 25 mm <sup>2</sup>	102048000	20,85 TL	50
WDU 35	1000 / 125	2.5 - 50 mm <sup>2</sup>	102050000	46,80 TL	40
WDU 35 BL	1000 / 125	2.5 - 50 mm <sup>2</sup>	102058000	46,80 TL	40
WDU 70/95	1000 / 232	16 - 120 mm <sup>2</sup>	102460000	374,20 TL	10
WDU 70/95 BL	1000 / 232	16 - 120 mm <sup>2</sup>	102468000	374,20 TL	10
WDU 120/150	1000 / 269	35 - 150 mm <sup>2</sup>	102450000	527,00 TL	10
WDU 120/150 BL	1000 / 269	35 - 150 mm <sup>2</sup>	102458000	527,00 TL	10
WDU 240	1000 / 415	70 - 240 mm <sup>2</sup>	180278000	570,00 TL	2
WDU 240 BL	1000 / 415	70 - 240 mm <sup>2</sup>	182221000	570,00 TL	2



WDU 2.5



WDU 2.5 BL

### Renk Tipleri



WDU 2.5	102000	102008	102006	103771	102002	102009	102004	102001	103770	103680
WDU 4	102010	102018	103676	103781	102012	102016	102014	102011	103782	103670
WDU 6	102020	102028	102026	-	104022	102029	102024	102021	-	-
WDU 10	102030	102038	102036	-	-	-	102034	102031	-	-
WDU 16	102040	102048	-	-	-	-	-	-	-	-
WDU 35	102050	102058	-	-	-	-	-	-	-	-



WDU 2.5/1.5/ZR



WDK 2.5

Tip	V / A	Kesit - mm <sup>2</sup> (Yüksüksüz)	Sipariş No	Fiyat/Birim	Ambalaj
<b>İkili Geçiş Klemensleri</b>					
WDU 2.5/1.5/ZR	800 / 24	0.5 - 4 mm <sup>2</sup> / 2 x 0.5 - 1.5 mm <sup>2</sup>	102470000	32,50 TL	100
WDU 1.5/ZZ	800 / 17.5	0.5 - 2.5 mm <sup>2</sup>	103140000	32,50 TL	100
WDU 4/ZR	800 / 32	0.5 - 6 mm <sup>2</sup>	190514000	34,55 TL	50
WDU 4/ZZ	800 / 32	1.5 - 6 mm <sup>2</sup>	190506000	38,25 TL	50
WDU 10/ZR	800 / 57	1.5 - 16 mm <sup>2</sup>	104240000	51,80 TL	50

### İki Katlı Klemensler (Her İki Kat Köprülenebilir)

WDK 2.5	400 / 24	0.5 - 4 mm <sup>2</sup>	102150000	18,60 TL	100
WDK 2.5 BL	400 / 24	0.5 - 4 mm <sup>2</sup>	102158000	18,60 TL	100
WDK 2.5V	400 / 24	0.5 - 4 mm <sup>2</sup>	102230000	69,65 TL	50
WDK 10	800 / 57	1.5 - 16 mm <sup>2</sup>	118674000	74,85 TL	50
WDK 10 BL	800 / 57	1.5 - 16 mm <sup>2</sup>	118675000	74,85 TL	50

### Üç Katlı Klemensler (Her Üç Kat Köprülenebilir)

DLD 2.5 DB	250 / 24	0.5 - 4 mm <sup>2</sup>	178418000	47,45 TL	50
DLD 2.5/PE DB	250 / 24	0.5 - 4 mm <sup>2</sup>	178379000	54,90 TL	50
WDL 2.5/S/N/L/PE	400 / 24	0.5 - 4 mm <sup>2</sup>	103070000	47,45 TL	50
WDL 2.5/S/L/L/PE	400 / 24	0.5 - 4 mm <sup>2</sup>	103110000	46,15 TL	50
WDL 2.5/N/L/PE	400 / 24	0.5 - 4 mm <sup>2</sup>	102990000	59,00 TL	50
WDL 2.5/L/L/PE	400 / 24	0.5 - 4 mm <sup>2</sup>	103020000	56,85 TL	50



DLD 2.5 DB



DLI 2.5 DB



MAK 2.5 DB



WPE 2.5



WNT 2.5 10X3



WTR 2.5



WTL 6/1

Tip	V / A	Kesit - mm <sup>2</sup> (Yüksüksüz)	Sipariş No	Fiyat/Birim	Ambalaj
<b>Sensör - Aktüatörler için Köprülenebilir Beslemeli, Üç Katlı Klemensler</b>					
DLI 2.5 DB	250 / 24	0.5 - 4 mm <sup>2</sup>	1783820000	52,55 TL	100
DLI 2.5/LD-RT/PNP +- DB	30 / 24	0.5 - 4 mm <sup>2</sup>	1783980000	99,25 TL	50
DLI 2.5/LD-RT/NPN +- DB	30 / 24	0.5 - 4 mm <sup>2</sup>	1783950000	99,25 TL	50
DLA 2.5 DB	250 / 17.5	0.5 - 4 mm <sup>2</sup>	1783560000	67,00 TL	100
DLA 2.5/LD-RT DB	30 / 17.5	0.5 - 4 mm <sup>2</sup>	1783600000	92,80 TL	50
DLA 2.5/D DB	250 / 17,5	0.5 - 4 mm <sup>2</sup>	1783590000	63,95 TL	100
<b>Dört Katlı Klemens ( 3 Faz + Toprak, Motor Bağlantıları İçin)</b>					
MAK 2.5 DB	500 / 24	0.5 - 4 mm <sup>2</sup>	7917030000	87,10 TL	50
VLI 1.5 DB	250 / 17,5	0.5 - 2.5 mm <sup>2</sup>	1784120000	43,25 TL	50
VLI 1.5/PE DB	250 / 17,5	0.5 - 2.5 mm <sup>2</sup>	1784130000	62,70 TL	50
<b>Topraklama Klemensleri</b>					
WPE 2.5	800	0.05 - 4 mm <sup>2</sup>	1010000000	22,60 TL	100
WPE 4	800	0.5 - 6 mm <sup>2</sup>	1010100000	29,85 TL	100
WPE 6	1000	0.5 - 10 mm <sup>2</sup>	1010200000	39,55 TL	50
WPE 10	1000	1.5 - 16 mm <sup>2</sup>	1010300000	40,95 TL	50
WPE 16	1000	1.5 - 25 mm <sup>2</sup>	1010400000	59,75 TL	50
WPE 35	800	2.5 - 50 mm <sup>2</sup>	1010500000	95,00 TL	25
WPE 70/95	1000	16 - 95 mm <sup>2</sup>	1037300000	541,00 TL	10
WPE 120/150	1000	95 - 150 mm <sup>2</sup>	1019700000	774,00 TL	10
<b>Nötr (N) - Ayrırma Klemensleri (10x3 mm'lik Baralar İçin)</b>					
WNT 2.5 10X3	400 / 24	0.13 - 4 mm <sup>2</sup>	1010680000	38,25 TL	100
WNT 4 10X3	400 / 32	0.5 - 6 mm <sup>2</sup>	1010780000	38,90 TL	100
WNT 6 10X3	400 / 41	0.5 - 10 mm <sup>2</sup>	1010880000	43,90 TL	50
WNT 10 10X3	400 / 57	1.5 - 16 mm <sup>2</sup>	1010980000	51,80 TL	50
WNT 16N 10X3	400 / 76	1.5 - 25 mm <sup>2</sup>	1019000000	63,30 TL	50
<b>Ölçme Ayrırma Klemensleri</b>					
WTR 2.5	500 / 24	0.5 - 2.5 mm <sup>2</sup> / Test ayırma	1855610000	40,30 TL	100
WTR 2.5 STB2.3	500 / 24	0.5 - 2.5 mm <sup>2</sup> / Test ayırma / Test Soket	1855620000	45,90 TL	100
WTR 2.5/ZZ	400 / 16	0.5 - 2.5 mm <sup>2</sup> / Test ayırma / iki giriş, iki çıkış	1039900000	59,75 TL	100
WTR 4	400 / 32	0.5 - 4 mm <sup>2</sup> / Test ayırma	7910180000	56,85 TL	50
WTR 4 STB	400 / 32	0.5 - 4 mm <sup>2</sup> / Test ayırma / Test Soket	7910210000	63,30 TL	50
WTR 4/ZZ	500 / 27	0.5 - 4 mm <sup>2</sup> / Test ayırma / iki giriş, iki çıkış	1905090000	69,00 TL	50
WTL 4	500 / 32	0.5 - 4 mm <sup>2</sup> / Sürgü ayırma	1754960000	54,65 TL	50
WTL 4/STB	500 / 32	0.5 - 4 mm <sup>2</sup> / Sürgü ayırma / Test Soket	1754970000	59,00 TL	50
WTL 6/1 EN	630 / 41	0.5 - 6 mm <sup>2</sup> / Sürgü ayırma	1934810000	53,75 TL	50
WTL 6/1 EN STB	630 / 41	0.5 - 6 mm <sup>2</sup> / Sürgü ayırma / Test Soket	1934820000	66,10 TL	50
WTL 6/1	630 / 41	0.5 - 6 mm <sup>2</sup> / Sürgü ayırma	1016700000	51,05 TL	50
WTL 6/1/STB	630 / 41	0.5 - 6 mm <sup>2</sup> / Sürgü ayırma / Test Soket	1016900000	51,80 TL	50
WTD 6/1 EN	630 / 41	0.5 - 6 mm <sup>2</sup> / Direk Besleme	1934830000	55,90 TL	50
WTL 6/2	500 / 41	0.5 - 6 mm <sup>2</sup> / Sürgü ayırma / Test Soket	1017700000	57,10 TL	50
WTL 6/3	500 / 41	0.5 - 6 mm <sup>2</sup> / Sürgü ayırma	1018800000	69,45 TL	50
WTL 6/3/STB	500 / 41	0.5 - 6 mm <sup>2</sup> / Sürgü ayırma / Test Soket	1018600000	111,55 TL	50

## W Serisi Ray Klemensleri - Vida Bağlantı Teknolojisi



WSI 4



KDKS 1/35 DB



WTR 2.5/SI



WSI 25/1 10x38



WDK 2.5 1D A.2



WDU 2.5N

Tip	V / A	Kesit - mm <sup>2</sup> (Yüksüksüz)	Sipariş No	Fiyat/Birim	Ambalaj
<b>Sigortalı Klemensler</b>					
WSI 4/2	500 / 6.3	0.5 - 4 mm <sup>2</sup> / G25 Sigorta	1880430000	31,70 TL	25
WSI 4/2/LD 10-36V AC/DC	500 / 6.3	0.5 - 4 mm <sup>2</sup> / G25 Sigorta / LED	1880410000	73,35 TL	25
WSI 4/2/LD 30-70V AC/DC	500 / 6.3	0.5 - 4 mm <sup>2</sup> / G25 Sigorta / LED	1880440000	73,35 TL	25
WSI 4/2/LD 60-150V AC/DC	500 / 6.3	0.5 - 4 mm <sup>2</sup> / G25 Sigorta / LED	1880420000	73,35 TL	25
WSI 4/2/LD 140-250V AC/DC	500 / 6.3	0.5 - 4 mm <sup>2</sup> / G25 Sigorta / LED	1880390000	73,35 TL	25
WSI 4	500 / 6.3	0.5 - 4 mm <sup>2</sup> / G20 Sigorta	1886580000	61,80 TL	50
WSI 4/LD 10-36V AC/DC	500 / 6.3	0.5 - 4 mm <sup>2</sup> / G20 Sigorta / LED	1886590000	95,00 TL	50
WSI 4/LD 30-70V AC/DC	500 / 6.3	0.5 - 4 mm <sup>2</sup> / G20 Sigorta / LED	1886560000	95,00 TL	50
WSI 4/LD 60-150V AC/DC	500 / 6.3	0.5 - 4 mm <sup>2</sup> / G20 Sigorta / LED	1886570000	95,00 TL	50
WSI 4/LD 140-250V AC/DC	500 / 6.3	0.5 - 4 mm <sup>2</sup> / G20 Sigorta / LED	1886550000	95,00 TL	50
KDKS 1/35 DB	500 / 6.3	0.5 - 4 mm <sup>2</sup> / G20 Sigorta / İki katlı	9532440000	84,10 TL	50
WSI 6	500 / 6.3	0.5 - 6 mm <sup>2</sup> / G20 Sigorta	1011000000	37,25 TL	50
WSI 6/LD 10-36V DC/AC	500 / 6.3	0.5 - 4 mm <sup>2</sup> / G20 Sigorta / LED	1011300000	91,45 TL	10
WSI 6/LD 30-70V DC/AC	500 / 6.3	0.5 - 4 mm <sup>2</sup> / G20 Sigorta / LED	1012200000	91,45 TL	10
WSI 6/LD 60-150V DC/AC	500 / 6.3	0.5 - 4 mm <sup>2</sup> / G20 Sigorta / LED	1012300000	91,45 TL	10
WSI 6/LD 250AC	500 / 6.3	0.5 - 4 mm <sup>2</sup> / G20 Sigorta / LED	1012400000	91,45 TL	10
WTR 2.5/SI	400 / 6.3	0.5 - 2.5 mm <sup>2</sup> / G20 Sigorta	1763940000	78,40 TL	25
WTR 4 SI	400 / 6.3	0.5 - 4 mm <sup>2</sup> / G20 Sigorta	7910240000	90,05 TL	25
BEST/D	Max 250	WTR 2.5/ 1N4007 diyotlu fiş	1878560000	78,40 TL	50
<b>Sigortalar</b>					
G 20/0.25A/F	0.25	Sigorta	0430500000	13,55 TL	10
G 20/0.50A/F	0.5	Sigorta	0430600000	15,70 TL	10
G 20/1.00A/F	1	Sigorta	0430700000	13,55 TL	10
G 20/2.00A/F	2	Sigorta	0430900000	13,55 TL	10
<b>Buşon Sigortalı Klemensler</b>					
WSI 25/1 10x38	690 / 32	0.5 - 25mm <sup>2</sup> / Buşon Sigorta / 1 Kutup	1966020000	92,80 TL	12
WSI 25/2 10x38	690 / 32	0.5 - 25mm <sup>2</sup> / Buşon Sigorta / 2 Kutup	1966090000	171,25 TL	6
WSI 25/3 10x38	690 / 32	0.5 - 25mm <sup>2</sup> / Buşon Sigorta / 3 Kutup	1966080000	279,85 TL	4
WSI 25/1 10x38/LED	690 / 32	0.5 - 25mm <sup>2</sup> / Buşon Sigorta / 1 Kutup / LED	1966060000	159,70 TL	12
WSI 25/1 10x38 1KV	1000 / 32	0.5 - 25mm <sup>2</sup> / Buşon Sigorta / 1 Kutup	1137790000	90,00 TL	12
WSI 25/1 10x38/LED 1KV	1000 / 32	0.5 - 25mm <sup>2</sup> / Buşon Sigorta / 1 Kutup / LED	1137780000	180,00 TL	12
<b>Diyotlu Klemensler</b>					
WDK 2.5 1D A.2	400 / 10	0.05 - 4 mm <sup>2</sup>	1023300000	87,75 TL	25
WDK 2.5 1D A.1	400 / 10	0.05 - 4 mm <sup>2</sup>	1023400000	87,75 TL	25
WDK 2.5 2D	400 / 10	0.05 - 4 mm <sup>2</sup>	1023500000	87,75 TL	25
WDK 2.5 2D 2.A	400 / 10	0.05 - 4 mm <sup>2</sup>	1022600000	87,75 TL	25
WDK 2.5 LD RT 24VDC +-	.24 / 10	0.05 - 4 mm <sup>2</sup>	1023600000	123,05 TL	25
<b>Kompakt (Küçük) Tip Klemensler / Geçiş Klemensleri</b>					
WDU 2.5N	500 / 24	0.05 - 4 mm <sup>2</sup>	1023700000	6,72 TL	100
WDU 2.5N BL	500 / 24	0.05 - 4 mm <sup>2</sup>	1023780000	6,72 TL	100
WDU 4N	500 / 32	0.5 - 6 mm <sup>2</sup>	1042600000	14,45 TL	100
WDU 4N BL	500 / 32	0.5 - 6 mm <sup>2</sup>	1042680000	14,45 TL	100
WDU 16N	690 / 76	1.5 - 25 mm <sup>2</sup>	1036100000	35,20 TL	50
WDU 16N BL	690 / 76	1.5 - 25 mm <sup>2</sup>	1036180000	35,20 TL	50
WDU 35N	500 / 125	2.5 - 50 mm <sup>2</sup>	1040400000	74,85 TL	20
WDU 35N BL	500 / 125	2.5 - 50 mm <sup>2</sup>	1040480000	74,85 TL	20
WDU 50N	1000 / 150	16 - 70 mm <sup>2</sup>	1820840000	188,45 TL	10
WDU 50N BL	1000 / 150	16 - 70 mm <sup>2</sup>	1820850000	188,45 TL	10
WDU 70N/35	1000 / 192	35 - 95 mm <sup>2</sup>	9512190000	254,70 TL	10

Serinin devamı sayfa 5



WDK 2.5N



WPE 2.5N



WPE 50N



WFF 1.5/R3.5



WFF 185



WFF 35

Tip	V / A	Kesit - mm <sup>2</sup> (Yüksüksüz)	Sipariş No	Fiyat/Birim	Ambalaj
WDU 70N/35 BL	1000 / 192	35 - 95 mm <sup>2</sup>	9512420000	254,70 TL	10
WDU 95N/120N	1000 / 269	16.0 - 150 mm <sup>2</sup>	1820550000	328,65 TL	5
WDU 95N/120N BL	1000 / 269	16.0 - 150 mm <sup>2</sup>	1820560000	328,65 TL	5

#### Kompakt (Küçük) İki Katlı Klemensler (Her İki Kat Köprülenebilir)

WDK 2.5N	800 / 24	0.05 - 4 mm <sup>2</sup>	1041600000	29,10 TL	100
WDK 2.5N BL	800 / 24	0.05 - 4 mm <sup>2</sup>	1041680000	29,10 TL	100
WDK 2.5N V	800 / 24	0.5 - 4 mm <sup>2</sup> - İki kat köprülü	1041610000	83,40 TL	100
WDK 2.5N DU-PE	800 / 24	0.5 - 4 mm <sup>2</sup> - Alt kat topraklama	1041650000	73,35 TL	100
WDK 4N	800 / 32	0.5 - 6 mm <sup>2</sup>	1041900000	30,95 TL	100
WDK 4N BL	800 / 32	0.5 - 6 mm <sup>2</sup>	1041980000	30,95 TL	100
WDK 4N V	800 / 32	0.5 - 6 mm <sup>2</sup> - İki kat köprülü	1041910000	84,10 TL	100
WDK 4N DU-PE	800 / 32	0.5 - 6 mm <sup>2</sup> - Alt kat topraklama	1041950000	72,65 TL	100

#### Kompakt (Küçük) Topraklama Klemensleri

WPE 2.5N	500	0.05 - 4 mm <sup>2</sup>	1016200000	52,55 TL	100
WPE 4N	500	0.13 - 6 mm <sup>2</sup>	1042700000	54,05 TL	100
WPE 16N	400	1.50 - 25 mm <sup>2</sup>	1019100000	96,45 TL	50
WPE 35N	400	2.50 - 50 mm <sup>2</sup>	1717740000	131,70 TL	20
WPE 50N	1000	10.0 - 70 mm <sup>2</sup>	1846040000	358,95 TL	10
WPE 70N/35	1000	10.0 - 95 mm <sup>2</sup>	9512200000	481,95 TL	10
WPE 95N/120N	1000	16.0 - 150 mm <sup>2</sup>	1846030000	543,00 TL	5

Tip	V / A	Kesit (Yüksüksüz)	Sipariş No	Fiyat/Birim	Ambalaj
-----	-------	-------------------	------------	-------------	---------

#### W Serisi Mini Klemens

WDU 1.5/R3.5	400 / 17.5	0.5 - 1.5 mm <sup>2</sup>	1753280000	25,10 TL	100
WDU 1.5/R3.5 BL	400 / 17.5	0.5 - 1.5 mm <sup>2</sup>	1754170000	25,10 TL	100

#### W Serisi Mini İki Katlı Klemens

WDK 1.5/R3.5	400 / 16	0.5 - 1.5 mm <sup>2</sup>	1753290000	57,50 TL	100
--------------	----------	---------------------------	------------	----------	-----

#### W Serisi Mini Topraklama Klemens

WPE 1.5/R3.5	400	0.5 - 1.5 mm <sup>2</sup>	1798460000	61,80 TL	50
--------------	-----	---------------------------	------------	----------	----

Tip	V / A	Kesit - mm <sup>2</sup> (Yüksüksüz)	Sipariş No	Fiyat/Birim	Ambalaj
-----	-------	-------------------------------------	------------	-------------	---------

#### WFF Papuç Bağlantılı Klemensler

WFF 35	1100 / 109	2.5...50 mm <sup>2</sup>	1028300000	165,40 TL	10
WFF 35 BL	1100 / 109	2.5...50 mm <sup>2</sup>	1028380000	165,40 TL	10
WFF 70	1100 / 167	2.5...95 mm <sup>2</sup>	1028400000	230,95 TL	10
WFF 70 BL	1100 / 167	2.5...95 mm <sup>2</sup>	1028480000	230,95 TL	10
WFF 120	1100 / 234	16...150 mm <sup>2</sup>	1028500000	330,95 TL	5
WFF 120 BL	1100 / 234	16...150 mm <sup>2</sup>	1028580000	330,95 TL	5
WFF 185	1100 / 307	25...240 mm <sup>2</sup>	1028600000	454,00 TL	4
WFF 185 BL	1100 / 307	25...240 mm <sup>2</sup>	1028680000	454,00 TL	4
WFF 300	1100 / 425	50...300 mm <sup>2</sup>	1028700000	539,00 TL	4

Tip	V / A	Sipariş No	Fiyat/Birim	Ambalaj
-----	-------	------------	-------------	---------

#### WFF Serisi Üst Kapak

WAH 35	WFF 35 Üst Kapak	1064460000	26,60 TL	20
WAH 35 BL	WFF 35 Üst Kapak Mavi	1064480000	26,60 TL	20
WAH 70 BE	WFF 70 Üst Kapak	1064560000	31,70 TL	20
WAH 70 BL	WFF 70 Üst Kapak Mavi	1064580000	31,70 TL	20
WAH 120	WFF 120 Üst Kapak	1064660000	38,25 TL	20
WAH 120 BL	WFF 120 Üst Kapak Mavi	1064680000	38,25 TL	20
WAH 185/300 BE	WFF 185/300 Üst Kapak	1064760000	58,60 TL	10
WAH 185/300 BL	WFF 185/300 Üst Kapak Mavi	1064780000	58,60 TL	10



## W Serisi Ray Klemensleri - Vida Bağlantı Teknolojisi



WEW 35/2



ZEWS 35



WAP 2.5-10 BL



ZAP/TW 1



WAP WDK 2.5N/TR-DU



WQV 2.5/2

Tip	Açıklama	Sipariş No	Fiyat/Birim	Ambalaj
<b>Klemens Durdurucuları</b>				
EW 35	Vidalı Küçük Tip	0383560000	6,72 TL	50
WEW 35/1	Vidalı Tip	1059000000	45,30 TL	50
WEW 35/2	Vidalı Tip	1061200000	28,35 TL	100
WEW 35/2 SW	Vidalı Tip Siyah	1061210000	28,35 TL	100
ZEW 35	Vidasız Tip 6mm Kalınlık	9540000000	6,79 TL	20
ZEW 35/2	Vidasız Tip 8mm Kalınlık	8630740000	7,73 TL	20
ZEW 35/2 SW	Vidasız Tip 8mm Kalınlık Siyah	1162610000	8,67 TL	20
EW 15	Vidalı Mini Tip	0382860000	6,65 TL	50

Tip	Açıklama	Sipariş No	Fiyat/Birim	Ambalaj
<b>Nihayet Plakaları</b>				
WAP 2.5-10	WDU 2.5-10 / WPE / WSI / WTR Serisi	1050000000	4,97 TL	50
WAP 2.5-10 BL	WDU 2.5-10 / WPE / WSI / WTR Serisi Mavi	1050080000	4,97 TL	50
WAP 16+35 WTW 2.5-10	WDU 16-35 Serisi	1050100000	7,06 TL	20
WAP 16+35 WTW 2.5-10 BL	WDU 16-35 Serisi Mavi	1050180000	7,06 TL	20
WAP WDU/WTR4/ZR	WTR4/ZR Serisi	1905070000	9,88 TL	50
WAP WDU/WTR4/ZZ	WTR4/ZZ Serisi	1905150000	9,88 TL	50
WAP WDK2.5	WDK 2.5 Serisi	1059100000	9,54 TL	20
WAP WDK2.5 BL	WDK 2.5 Serisi Mavi	1059180000	9,54 TL	20
WAP WDK10	WDK 10 Serisi	1186720000	21,40 TL	20
WAP WDK10 BL	WDK 10 Serisi Mavi	1186730000	21,40 TL	20
AP DLI2.5 DB	DLI / DLA Serisi	1783550000	15,05 TL	20
AP DLD2.5 DB	DLD Serisi	1784210000	15,05 TL	20
WAP WDL2.5	WDL Serisi	1067800000	9,00 TL	20
AP MAK2.5 DB	MAK Serisi	7917000000	18,10 TL	20
AP VLI1.5 DB	VLI 1.5 Serisi	1784150000	14,55 TL	20
AP VLI1.5/PE DB	VLI 1.5/PE Serisi	1784160000	11,20 TL	20
WAP WTR2.5/ZZ	WTR2.5/ZZ Serisi	1074600000	9,27 TL	20
ZAP/TW 1	ZDU 2.5	1608740000	5,44 TL	50
WAP WTL4/2	WTL 4/2 Serisi	1881640000	11,50 TL	50
WAP WTL6/1 EN	WTL 6/1 EN Serisi	1957710000	10,75 TL	20
WAP WTL6/1	WTL 6/1 Serisi	1068300000	8,67 TL	20
WAP WDK 2.5N/TR-DU	WDK 2.5N/TR-DU Serisi	1839850000	12,15 TL	50
WAP WSI4/2	WSI 4/2 Serisi	1880450000	4,23 TL	50
AP KDKS1 DB	KDKS 1/35 Serisi	9532470000	19,55 TL	20
WAP WDU2.5N/4N	WDU N Serisi 2.5-4	1060000000	5,85 TL	50
WAP WDU2.5N/4N BL	WDU N Serisi 2.5-4 Mavi	1060080000	5,85 TL	50
WAP WDK2.5/4 N	WDK N Serisi 2.5-4	1084000000	10,55 TL	20
WAP WDK2.5/4 N BL	WDK N Serisi 2.5-4 Mavi	1084080000	10,55 TL	20
TW SAKD2.5N	WDU2.5N Serisi Ayırma Plakası	0191860000	10,55 TL	20
WTW EN	WDU16N-35N Serisi Ayırma Plakası	1058800000	35,20 TL	20
WTW WTL6/1 DB	WTL6/1 Serisi Ayırma Plakası	1068400000	13,65 TL	20
WHP 2.5-35N/10x3 BL	WNT Serisi Bara Tutucu (10x3 mm Bara)	1050280000	11,00 TL	20
WAP WDU1.5/R3.5	WDU 1.5/R3.5 Serisi	1754190000	3,49 TL	20
WAP WDK1.5/R3.5	WDK 1.5/R3.5 Serisi	1754200000	12,00 TL	20

Tip	A	Kutup Sayısı	Sipariş No	Fiyat/Birim	Ambalaj
<b>Vidalı Klemens Üst Köprü</b>					
WQV 2.5/2	32	2 Kutup	1053660000	10,75 TL	50
WQV 2.5/3	32	3 Kutup	1053760000	15,10 TL	50
WQV 2.5/4	32	4 Kutup	1053860000	16,50 TL	50
WQV 2.5/5	32	5 Kutup	1053960000	19,45 TL	10
WQV 2.5/6	32	6 Kutup	1054060000	22,40 TL	10

Serinin devamı sayfa 7



WQV 2.5/10



WQV 4/3



WQV 6/4



WQV 35N/2



WQV 70/95/3

Tip	A	Kutup Sayısı	Sipariş No	Fiyat/Birim	Ambalaj
WQV 2.5/7	32	7 Kutup	1054160000	25,80 TL	10
WQV 2.5/8	32	8 Kutup	1054260000	29,45 TL	10
WQV 2.5/9	32	9 Kutup	1054360000	33,05 TL	10
WQV 2.5/10	32	10 Kutup	1054460000	40,95 TL	20
WQV 2.5/15	32	15 Kutup	1059660000	56,85 TL	10
WQV 2.5/20	32	20 Kutup	1577570000	78,40 TL	10
WQV 2.5/32	32	32 Kutup	1577600000	123,70 TL	10
WQV 4/2	41	2 Kutup	1051960000	13,65 TL	50
WQV 4/3	41	3 Kutup	1054560000	20,10 TL	50
WQV 4/4	41	4 Kutup	1054660000	25,80 TL	50
WQV 4/5	41	5 Kutup	1057860000	28,80 TL	10
WQV 4/6	41	6 Kutup	1057160000	34,25 TL	10
WQV 4/7	41	7 Kutup	1057260000	39,65 TL	10
WQV 4/10	41	10 Kutup	1052060000	61,05 TL	20
WQV 6/2	57	2 Kutup	1052360000	13,65 TL	50
WQV 6/3	57	3 Kutup	1054760000	19,95 TL	50
WQV 6/4	57	4 Kutup	1054860000	25,80 TL	50
WQV 6/5	57	5 Kutup	1062660000	32,80 TL	50
WQV 6/6	57	6 Kutup	1062670000	38,90 TL	50
WQV 6/7	57	7 Kutup	1062680000	44,65 TL	50
WQV 6/10	57	10 Kutup	1052260000	61,05 TL	20
WQV 10/2	57	2 Kutup	1052560000	15,10 TL	50
WQV 10/3	57	3 Kutup	1054960000	21,50 TL	50
WQV 10/4	57	4 Kutup	1055060000	31,70 TL	50
WQV 10/10	57	10 Kutup	1052460000	69,60 TL	20
WQV 16/2	101/76	2 Kutup	1053260000	18,25 TL	50
WQV 16/3	101/76	3 Kutup	1055160000	25,10 TL	50
WQV 16/4	101/76	4 Kutup	1055260000	33,70 TL	50
WQV 16/10	101/76	10 Kutup	1053360000	76,25 TL	10
WQV 16N/2	101/76	2 Kutup	1636560000	18,10 TL	50
WQV 16N/3	101/76	3 Kutup	1636570000	25,10 TL	50
WQV 16N/4	101/76	4 Kutup	1636580000	33,70 TL	50
WQV 35/2	112	2 Kutup	1053060000	25,10 TL	50
WQV 35/3	112	3 Kutup	1055360000	33,70 TL	50
WQV 35/4	112	4 Kutup	1055460000	48,15 TL	50
WQV 35/10	112	10 Kutup	1053160000	114,35 TL	10
WQV 35N/2	101	2 Kutup	1079200000	37,40 TL	20
WQV 35N/3	101	3 Kutup	1079300000	52,55 TL	20
WQV 35N/4	101	4 Kutup	1079400000	74,15 TL	20
WQV 50N/2	150	2 Kutup	1834060000	73,35 TL	5
WQV 50N/3	150	3 Kutup	1834070000	102,95 TL	5
WQV 50N/4	150	4 Kutup	1834080000	134,45 TL	5
WQV 70N/2	192	2 Kutup	9512240000	95,00 TL	5
WQV 70N/3	192	3 Kutup	9512250000	138,15 TL	5
WQV 70N/4	192	4 Kutup	9531290000	174,15 TL	5
WQV 70/95/2	192	2 Kutup	1063500000	228,75 TL	5
WQV 70/95/3	192	3 Kutup	1063600000	371,20 TL	5
WQV 95N/120N/2	269	2 Kutup	1826890000	142,45 TL	5
WQV 95N/120N/3	269	3 Kutup	1826900000	197,95 TL	5
WQV 95N/120N/4	269	4 Kutup	1826910000	261,05 TL	5
WQV 120/2	269	2 Kutup	1063300000	276,30 TL	5
WQV 120/3	269	3 Kutup	1063400000	387,00 TL	5

## W Serisi Ray Klemensleri - Vida Bağlantı Teknolojisi



ZQV 2.5N/2 GE



ZQV 2.5N/4 GE



ZQV 2.5N/10 GE



QL 4 SAK6N



STB 35 IH/GE



WKS 1/2

Tip	A	Kutup Sayısı	Sipariş No	Fiyat/Birim	Ambalaj
<b>Vidalı Klemens Tarak Üst Köprü</b>					
ZQV 2.5N/2 GE	24	2 Kutup	1693800000	5,51 TL	60
ZQV 2.5N/3 GE	24	3 Kutup	1693810000	9,54 TL	60
ZQV 2.5N/4 GE	24	4 Kutup	1693820000	13,65 TL	60
ZQV 2.5N/5 GE	24	5 Kutup	1693830000	16,90 TL	20
ZQV 2.5N/6 GE	24	6 Kutup	1693840000	21,40 TL	20
ZQV 2.5N/7 GE	24	7 Kutup	1693850000	25,50 TL	20
ZQV 2.5N/8 GE	24	8 Kutup	1693860000	29,60 TL	20
ZQV 2.5N/9 GE	24	9 Kutup	1693870000	33,70 TL	20
ZQV 2.5N/10 GE	24	10 Kutup	1693880000	38,25 TL	20
ZQV 2.5N/20 GE	24	20 Kutup	1909000000	75,55 TL	20
ZQV 4N/2 GE	32	2 Kutup	1758250000	10,75 TL	60
ZQV 4N/3 GE	32	3 Kutup	1762630000	15,45 TL	60
ZQV 4N/4 GE	32	4 Kutup	1762620000	21,50 TL	60
ZQV 4N/10 GE	32	10 Kutup	1758260000	51,05 TL	20
ZQV 4N/20 GE	32	20 Kutup	1909020000	84,80 TL	20

Tip	Açıklama	Sipariş No	Fiyat/Birim	Ambalaj
<b>Vidalı Klemens Tarak Üst Köprü</b>				
ZQV 1.5N/R3.5/2 GE	WDU 1.5 - WDK 1.5 Serisi / 2 Kutup	1754210000	5,51 TL	50
ZQV 1.5N/R3.5/3 GE	WDU 1.5 - WDK 1.5 Serisi / 3 Kutup	1754220000	11,20 TL	50
ZQV 1.5N/R3.5/4 GE	WDU 1.5 - WDK 1.5 Serisi / 4 Kutup	1754230000	16,50 TL	20
ZQV 1.5N/R3.5/10 GE	WDU 1.5 - WDK 1.5 Serisi / 10 Kutup	1754290000	46,80 TL	20

Tip	A	Kutup Sayısı	Sipariş No	Fiyat/Birim	Ambalaj
<b>WSI 6 Serisi Bara Köprü</b>					
QL 2 SAK6N	24	2 Kutup	0194300000	5,60 TL	50
QL 3 SAK6N	24	3 Kutup	0194400000	6,72 TL	50
QL 4 SAK6N	24	4 Kutup	0194500000	7,84 TL	50
QL 10 SAK6N	24	10 Kutup	0338300000	16,80 TL	20
KISC M3X5	24	Köprü Vidası	1052100000	1,66 TL	100
WAW 2	Klemens Köprü Açma El Aleti		9004510000	1.118,00 TL	1

Tip	Açıklama	Sipariş No	Fiyat/Birim	Ambalaj
<b>WTL 6/1 Serisi Aksesuar</b>				
STB 25 IH/GE	Test Soketi Girişli Ölçüm Alma Vidası - Sarı	0267200000	22,60 TL	50
BS 25 IH/GE SAKT1	Ayırma Vidası - Sarı	0335700000	13,45 TL	50
STB 35 IH/GE	Test Soketi Girişli Ayırma Vidası - Sarı	0389000000	27,35 TL	50
STB 14/D6/4/M3 SAK10	Ölçüm Kovanı - Vidalı	0169900000	6,72 TL	50
VH 19/6/4.2 SAKT1	Vida Kovanı	0318000000	12,90 TL	50
SSP 3 SAKT1	İzolasyon Kapağı	0531760000	8,33 TL	100
QVS 2 SAKT1+2	Sürgülü Ölçme-Ayırma Köprüsü	0307300000	32,45 TL	20
QB 58/8/9/WI	Tarak Köprü - Kablo Bağlantı Noktasından	0545300000	123,20 TL	10
ISPF QB58 SW	Köprü İzolasyonu	0546000000	19,40 TL	10
WKS 1/2	WTL 6/2 Sürgü Köprü - İki Kutup - 1017700000 için	1604270000	25,80 TL	50

Tip	Kutup Sayısı	Sipariş No	Fiyat/Birim	Ambalaj
<b>MAK / VLI Serisi Klemens Tarak Köprü</b>				
VQB 1.5/50 BL	50 Kutup - Mavi	1633280000	179,20 TL	5
VQB 1.5/50 RT	50 Kutup - Kırmızı	1633290000	138,15 TL	5



WAD 5 MC NE WS



WTTB 6 PE



EP TTB 6

Tip	Açıklama	Sipariş No	Fiyat/Birim	Ambalaj	
<b>İzole Anahtarlı Ölçme Ayırma Klemens Aksesuarları</b>					
* WAD 5 MC NE WS	Grup Markalama	1112910000	3,16 TL	48	
* ZQV 6N/4	4'lü Üst Köprü	1985780000	20,05 TL	60	
Tip	V / A	Kesit - mm <sup>2</sup> (Yüksüksüz)	Sipariş No	Fiyat/Birim	Ambalaj
<b>İzole Anahtarlı Ölçme Ayırma Klemensleri</b>					
* WTTB 6	500 / 30	0.5 - 6 mm <sup>2</sup> / İzole Ayırma Anahtarlı / Bej	2710090000	57,35 TL	50
* WTTB 6 PE	500	0.5 - 6 mm <sup>2</sup> / İzole Ayırma Anahtarlı / Toprak	2710100000	68,15 TL	50
Tip	Açıklama	Sipariş No	Fiyat/Birim	Ambalaj	
<b>İzole Anahtarlı Ölçme Ayırma Klemens Aksesuarları</b>					
* AEB 35 SCL/1 VO	Durdurucu	2661280000	6,03 TL	20	
* SCCB TTB 6/2	2'li Kısa Devre Köprüsü	2710190000	9,50 TL	25	
* SCCB TTB 6/4	4'li Kısa Devre Köprüsü	2710210000	23,10 TL	25	
* LL TTB 6/1	Tekli Ayırma Aparatı	2710230000	0,718 TL	50	
* LL TTB 6/2	2'li Ayırma Aparatı	2710300000	1,08 TL	50	
* LL TTB 6/3	3'li Ayırma Aparatı	2710440000	5,41 TL	50	
* LL TTB 6/4	4'li Ayırma Aparatı	2710450000	16,10 TL	25	
* LL TTB 6/6	6'li Ayırma Aparatı	2710460000	23,55 TL	10	
* SL TTB 6	Anahtarlama Kilidi	2710220000	0,680 TL	50	
* EP TTB 6	Nihayet Plakası	2710170000	5,29 TL	20	
* WSA 8/8 MM WS	Klemens Markalama	2448930000	1,02 TL	500	

## Akım ve Gerilim Test Kutusu



KIT KLTR 2TR POCAN 4



TCN 4TR POCAN 8

Tip	Açıklama	Sipariş No	Fiyat/Birim	Ambalaj
<b>POCON 4 Akım ve Gerilim Test Kutusu</b>				
KIT KLTR 2TR POCAN 4	POCON 4 Terminal	1052150000	Sorunuz	Sorunuz
SDST 2TR POCAN 4	POCON 4 Kapak	1052160000	Sorunuz	Sorunuz
TCN 2TR POCAN 4	POCON 4 Test Soketi	1052180000	Sorunuz	Sorunuz
QV 2POL POCAN	2 kutuplu köprü	1091670000	Sorunuz	Sorunuz
QV 3POL POCAN	3 kutuplu köprü	1091680000	Sorunuz	Sorunuz
KOEL POCAN	Ayırma elementi	1091690000	Sorunuz	Sorunuz
<b>POCON 8 Akım ve Gerilim Test Kutusu</b>				
KIT KLTR 4TR POCAN 8	POCON 8 Terminal	1052140000	Sorunuz	Sorunuz
SDST 4TR POCAN 8	POCON 8 Kapak	1052170000	Sorunuz	Sorunuz
TCN 4TR POCAN 8	POCON 8 Test Soketi	1052080000	Sorunuz	Sorunuz
QV 2POL POCAN	2 kutuplu köprü	1091670000	Sorunuz	Sorunuz
QV 3POL POCAN	3 kutuplu köprü	1091680000	Sorunuz	Sorunuz
KOEL POCAN	Ayırma elementi	1091690000	Sorunuz	Sorunuz

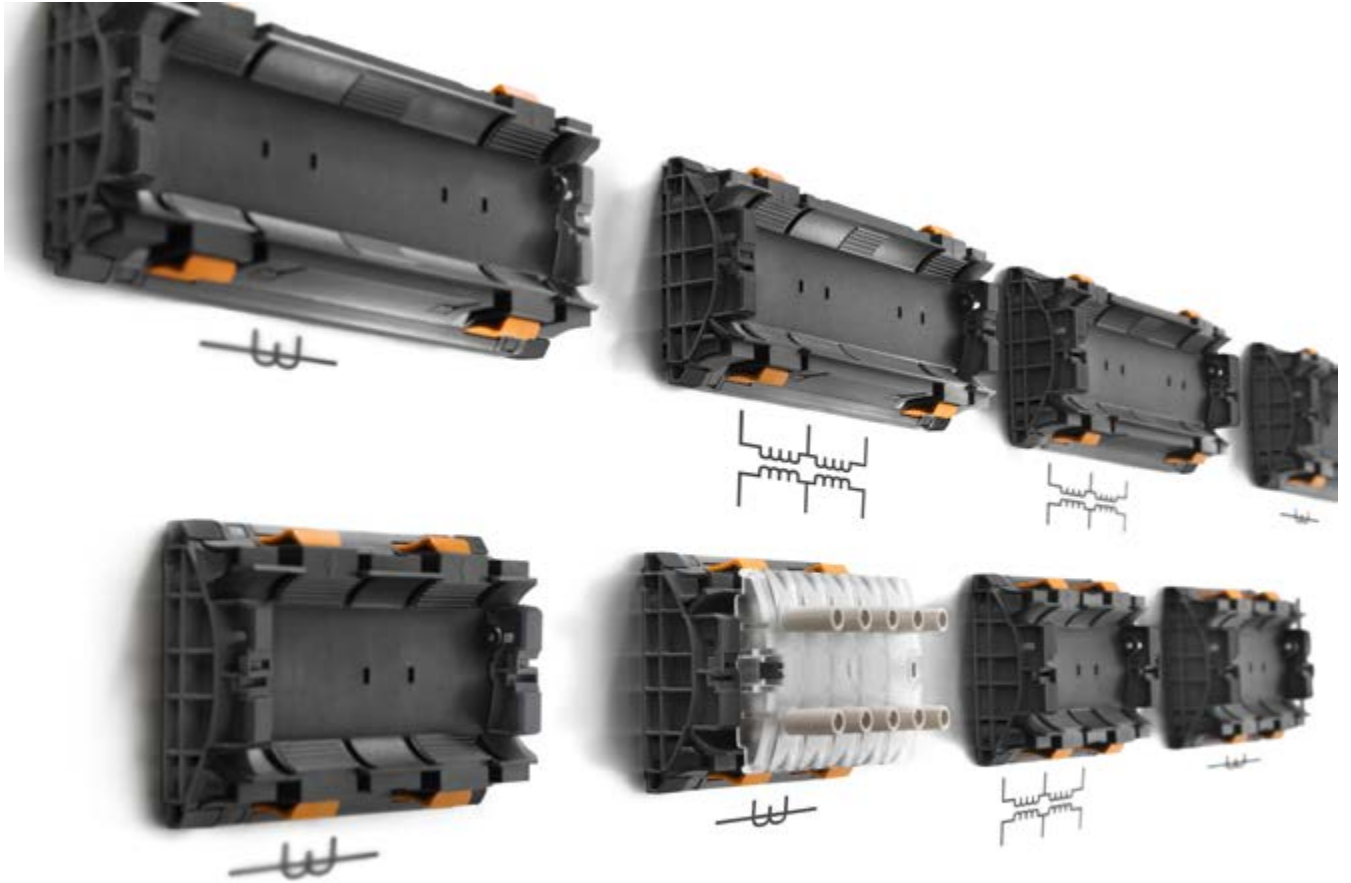



ZB 10 F.10X3/10X5/10X10



ZF 4 S



SH 2 S



KLBUE CO 1



MK 3/12



MK 6/6



WGK 4

Tip	Kesit	Sipariş No	Fiyat/Birim	Ambalaj	
<b>Bara Klemensleri</b>					
<b>İzolesiz Bara Klemensleri (10x3 mm'lik Bara için)</b>					
ZB 4	0.5 - 4 mm <sup>2</sup>	0316500000	6,18 TL	50	
ZBE 6	2.5 - 6 mm <sup>2</sup>	0459500000	10,75 TL	50	
ZB 10 F.10X3/10X5/10X10	1.5 - 10 mm <sup>2</sup>	1261300000	10,75 TL	50	
ZB 16 ZKSC	2.5 - 16 mm <sup>2</sup>	0316600000	11,95 TL	50	
ZB 35/M6X16	16 - 35 mm <sup>2</sup>	0266500000	15,10 TL	20	
<b>İzoleli Bara Klemensleri (10x3 mm'lik Bara için)</b>					
ZB 4K BL	0.5 - 4 mm <sup>2</sup>	0475380000	9,34 TL	50	
ZB 4K GE/GN	0.5 - 4 mm <sup>2</sup>	0475360000	11,30 TL	50	
ZBE 6K BL	2.5 - 6 mm <sup>2</sup>	0525980000	16,25 TL	50	
ZBE 6K GE/GN	2.5 - 6 mm <sup>2</sup>	0525960000	16,25 TL	50	
ZB 16K BL	2.5 - 16 mm <sup>2</sup>	0502880000	17,20 TL	50	
ZB 16K GE/GN	2.5 - 16 mm <sup>2</sup>	0502860000	17,20 TL	50	
ZB 35K BL M6X16	16 - 35 mm <sup>2</sup>	0502680000	23,80 TL	20	
ZB 35K GE/GN M6X16	16 - 35 mm <sup>2</sup>	0502660000	23,80 TL	20	
<b>Yayı İzoleli Bara Klemensleri (10x3 mm'lik Bara için)</b>					
ZF 4 S	0.5 - 4 mm <sup>2</sup>	1814680000	12,75 TL	50	
ZF 4 S BL	0.5 - 4 mm <sup>2</sup>	1814660000	12,75 TL	50	
ZF 4 S GN	0.5 - 4 mm <sup>2</sup>	1814670000	12,75 TL	50	
SSCH 10X3X1000 CU/SN	10x3 Bakır Bara	0348900000	176,85 TL	1M	
<b>Bara Tutucular</b>					
SH 1	10x3 / 6x6 / 15x2x12x2 mm	0299860000	19,40 TL	20	
SH 2 S	10x3 / 6x6 / 15x6x10x5 mm	0641720000	60,40 TL	10	
SH 3	10x3 / 6x6 / 10x5 mm	0556660000	31,00 TL	10	
<b>Ekranlama Klemensleri</b>					
KLBUE CO 1	Ø 3...10 mm	1753311001	67,00 TL	10	
KLBUE CO 2	Ø 4...15 mm	1752131001	78,40 TL	10	
KLBUE CO 3	Ø 10...20 mm	1749151001	106,50 TL	10	
KLBUE CO 4	Ø 15...28 mm	1749161001	147,50 TL	10	
KLBUE CO 5	Ø 20...37 mm	1755081001	324,80 TL	10	
Tip	V / A	Açıklama	Sipariş No	Fiyat/Birim	Ambalaj
<b>Cihaz Sıra Klemensleri</b>					
MK 3/2	400 / 24	0.5 - 4 mm <sup>2</sup> / 2 Kutup	0273820000	22,40 TL	100
MK 3/3	400 / 24	0.5 - 4 mm <sup>2</sup> / 3 Kutup	0273920000	24,45 TL	50
MK 3/4	400 / 24	0.5 - 4 mm <sup>2</sup> / 4 Kutup	0274020000	33,05 TL	50
MK 3/6	400 / 24	0.5 - 4 mm <sup>2</sup> / 6 Kutup	0274220000	45,30 TL	50
MK 3/8	400 / 24	0.5 - 4 mm <sup>2</sup> / 8 Kutup	0274420000	82,10 TL	25
MK 3/10	400 / 24	0.5 - 4 mm <sup>2</sup> / 10 Kutup	0274620000	85,55 TL	20
MK 3/12	400 / 24	0.5 - 4 mm <sup>2</sup> / 12 Kutup	0243520000	90,05 TL	20
MK 6/2	690 / 21	0.5 - 6 mm <sup>2</sup> / 2 Kutup	0620420000	53,20 TL	50
MK 6/3	690 / 21	0.5 - 6 mm <sup>2</sup> / 3 Kutup	0620320000	74,10 TL	50
MK 6/4	690 / 21	0.5 - 6 mm <sup>2</sup> / 4 Kutup	0620220000	85,55 TL	20
MK 6/6	690 / 21	0.5 - 6 mm <sup>2</sup> / 6 Kutup	0620120000	122,30 TL	20
<b>Panel Geçiş Klemensleri</b>					
WGK 4	250 / 32	0.5 - 6 mm <sup>2</sup>	1936550000	25,75 TL	50
WGK 95	690 / 232	35 - 95 mm <sup>2</sup>	1937380000	235,20 TL	10

## WMF Serisi Marshalling Ray Klemensleri - Vida Bağlantı Teknolojisi



WMF 2.5



WMF 2.5 DI



WMF 2.5 FU SW



WMF 2.5 BLZ



WDU 1.5/BLZ 5.08



WDK 2.5/TR-DU-PE

SIHA 3/G20

Tip	V / A	Kesit - mm <sup>2</sup> (Yüksüksüz)	Sipariş No	Fiyat/Birim	Ambalaj
<b>WMF Serisi Geçiş Klemensleri</b>					
WMF 2.5	800 / 24	0.5 - 4 mm <sup>2</sup> / Geçiş Klemensi	1143070000	18,10 TL	50
WMF 2.5 BL	800 / 24	0.5 - 4 mm <sup>2</sup> / Geçiş Klemensi / Mavi	1270040000	18,10 TL	50
WMF 2.5 DI	800 / 24	0.5 - 4 mm <sup>2</sup> / Ayırma Klemensi	1143020000	66,25 TL	50
WMF 2.5 DI BL	800 / 24	0.5 - 4 mm <sup>2</sup> / Ayırma Klemensi / Mavi	1270070000	66,25 TL	50
WMF 2.5 DI PE	800 / 24	0.5 - 4 mm <sup>2</sup> / Ayırma Klemensi / Toprak	1143030000	118,05 TL	50
WMF 2.5 DI PE BL	800 / 24	0.5 - 4 mm <sup>2</sup> / Ayırma Klemensi / Toprak / Mavi	1270080000	118,05 TL	50
<b>Ayrma Sistem Sigortalı Klemens</b>					
WMF 2.5 FU SW	250 / 6.3	0.5 - 4 mm <sup>2</sup>	1162920000	100,75 TL	50
WMF 2.5 FU 10-36V SW	250 / 6.3	0.5 - 4 mm <sup>2</sup> / 10-36V LED	1162930000	155,35 TL	50
WMF 2.5 FU 30-70V SW	250 / 6.3	0.5 - 4 mm <sup>2</sup> / 30-70V LED	1162940000	156,15 TL	50
WMF 2.5 FU 60-150V SW	250 / 6.3	0.5 - 4 mm <sup>2</sup> / 60-150V LED	1162950000	156,15 TL	50
WMF 2.5 FU 100-250V SW	250 / 6.3	0.5 - 4 mm <sup>2</sup> / 100-250V LED	1162960000	155,35 TL	50
WMF 2.5 FU PE SW	250 / 6.3	0.5 - 4 mm <sup>2</sup> / İki Kat Alt Toprak	1163040000	148,85 TL	50
WMF 2.5 FU PE 10-36V SW	250 / 6.3	0.5 - 4 mm <sup>2</sup> / 10-36V LED / İki Kat Alt Toprak	1163050000	282,15 TL	50
WMF 2.5 FU PE 30-70V SW	250 / 6.3	0.5 - 4 mm <sup>2</sup> / 30-70V LED / İki Kat Alt Toprak	1163060000	283,45 TL	50
WMF 2.5 FU PE 60-150V SW	250 / 6.3	0.5 - 4 mm <sup>2</sup> / 60-150V LED / İki Kat Alt Toprak	1163070000	283,45 TL	50
WMF 2.5 FU PE 100-250V SW	250 / 6.3	0.5 - 4 mm <sup>2</sup> / 100-250V LED / İki Kat Alt Toprak	1163080000	282,80 TL	50
<b>BLZ Bağlantı Noktalı Geçiş ve Sigortalı Klemensler</b>					
WMF 2.5 BLZ	250 / 24	0.5 - 4 mm <sup>2</sup> / Geçiş Klemensi	1143050000	30,95 TL	50
WMF 2.5 DI BLZ	250 / 24	0.5 - 4 mm <sup>2</sup> / Ayırma Klemensi	1143000000	74,85 TL	50
WMF 2.5 DI BLZ PE	250 / 24	0.5 - 4 mm <sup>2</sup> / Ayırma Klemensi / Toprak	1143010000	138,80 TL	50
WMF 2.5 FU BLZ SW	250 / 24	0.5 - 4 mm <sup>2</sup>	1162980000	129,40 TL	50
WMF 2.5 FU BLZ 10-36V SW	250 / 24	0.5 - 4 mm <sup>2</sup> / 10-36V LED	1162990000	235,20 TL	50
WMF 2.5 FU BLZ 30-70V SW	250 / 24	0.5 - 4 mm <sup>2</sup> / 30-70V LED	1163000000	235,20 TL	50
WMF 2.5 FU BLZ 60-150V SW	250 / 24	0.5 - 4 mm <sup>2</sup> / 60-150V LED	1163010000	235,20 TL	50
WMF 2.5 FU BLZ 100-250V SW	250 / 24	0.5 - 4 mm <sup>2</sup> / 100-250V LED	1163020000	235,20 TL	50
WMF 2.5 FU BLZ PE SW	250 / 24	0.5 - 4 mm <sup>2</sup> / İki Kat Alt Toprak	1162820000	179,80 TL	50
WMF 2.5 FU BLZ PE 10-36V SW	250 / 24	0.5 - 4 mm <sup>2</sup> / 10-36V LED / İki Kat Alt Toprak	1162830000	313,55 TL	50
WMF 2.5 FU BLZ PE 30-70V SW	250 / 24	0.5 - 4 mm <sup>2</sup> / 30-70V LED / İki Kat Alt Toprak	1162840000	313,55 TL	50
WMF 2.5 FU BLZ PE 60-150V SW	250 / 24	0.5 - 4 mm <sup>2</sup> / 60-150V LED / İki Kat Alt Toprak	1162850000	313,55 TL	50
WMF 2.5 FU BLZ PE 100-250V SW	250 / 24	0.5 - 4 mm <sup>2</sup> / 100-250V LED / İki Kat Alt Toprak	1162860000	313,55 TL	50
<b>Soket Bağlantılı Klemensler</b>					
WDU 1.5/BLZ 5.08	250 / 16	0.5 - 4 mm <sup>2</sup> / 2xBLZ Soket	1577340000	29,45 TL	100
WDK 2.5/BLZ/5.08/ZA	250 / 16	0.5 - 4 mm <sup>2</sup> / 2xBLZ Soket	1034400000	38,25 TL	50
WT4 4AN/2	800 / 32	0.5 - 6 mm <sup>2</sup> / 2xZP Soket	1107680000	41,90 TL	50
<b>İki ve Üç Katlı Ayırma ve Sigorta Sistem Klemensler</b>					
WDK 2.5/TR-DU	690 / 24	0.5 - 2.5 mm <sup>2</sup> / Test ayırma / İki Katlı	1247290000	84,10 TL	50
WDK 2.5/TR-DU STB	690 / 24	0.5 - 2.5 mm <sup>2</sup> / Test ayırma / Test Soket / İki Katlı	1247310000	95,00 TL	50
WDK 2.5/TR-DU-PE	690 / 24	0.5 - 2.5 mm <sup>2</sup> / Test ayırma / Üç Katlı	1247420000	135,30 TL	50
WDK 2.5/TR-DU-PE STB	690 / 24	0.5 - 2.5 mm <sup>2</sup> / Test ayırma / Test Soket / Üç Katlı	1247430000	149,50 TL	50
WDK 2.5/TR-DU/o TNHE	690 / 24	0.5 - 4 mm <sup>2</sup> / İki Kat / SIHA ve BEST modü	1833600000	74,15 TL	50
WDK 2.5/TR-DU/o TNHE StB	690 / 24	0.5 - 4 mm <sup>2</sup> / İki Kat / SIHA ve BEST modü	1833610000	84,10 TL	50
WDK 2.5/TR-DU-PE/o TNHE	690 / 24	0.5 - 4 mm <sup>2</sup> / Üç Kat / SIHA ve BEST modül / Toprak	1833640000	119,35 TL	50
SIHA 3/G20	400	Sigorta Modül	7921560000	35,95 TL	25
SIHA 3/G20/LD 10-36V	10 - 36	10-36V AC-DC Led Sigorta Modül	7921570000	78,40 TL	25
SIHA 3/G20/LD 140-250V	140 - 250	140-250V Led Sigorta Modül	7921600000	84,80 TL	25
BEST		Boş Modül	1833100000	59,00 TL	50
BEST/DRBR	400 / 41	Jumper Modül	1878570000	75,55 TL	50
BEST/D	Max 250	WTR 2.5/ 1N4007 diyotlu fiş	1878560000	78,40 TL	50

### Z Serisi Ray Klemensleri - Yaylı Bağlantı Teknolojisi

0.13 - 35 mm<sup>2</sup> arası iletkenlerin Z serisi yaylı klemenslere bağlantısı pratik bir şekilde gerçekleştirilir.

Z serisi yay bağlantılı klemensler müşteri istekleri doğrultusunda tasarlanmıştır;

- Küçük Tasarım
- Geniş Markalama Alanları
- Klemensle Bütünleştirilmiş Test Noktaları
- Üst Köprüler Z Serisi ve Diğer Serilerle Kullanılabilir.

Z serisi klemensler oldukça geniş sıkıştırma kesiti aralığına sahiptir ve iki kanal köprüleme yapmaya olanak verir. Bu sayede istenilen sayıda köprüleme yapılabilir.

Aşağıdaki versiyonlarda üretilmişlerdir :

#### Z-Standart

- 0,05 - 35 mm<sup>2</sup> arası iletken kesiti
- Tornavida yönünün paralelinde üstten iletken girişi

#### Bazı Klemens Tipleri:

- **ZDU** - Geçiş Klemensleri
- **ZPE** - Topraklama Klemensleri
- **ZNT** - Nötr Klemensleri
- **ZDL** - Üç İletkenli Dağıtım Klemensleri
- **ZTR** - Ölçme Ayırma Klemensleri
- **ZSI** - Sigortalı Klemensler
- **ZDK** - Çok Katlı Klemensler

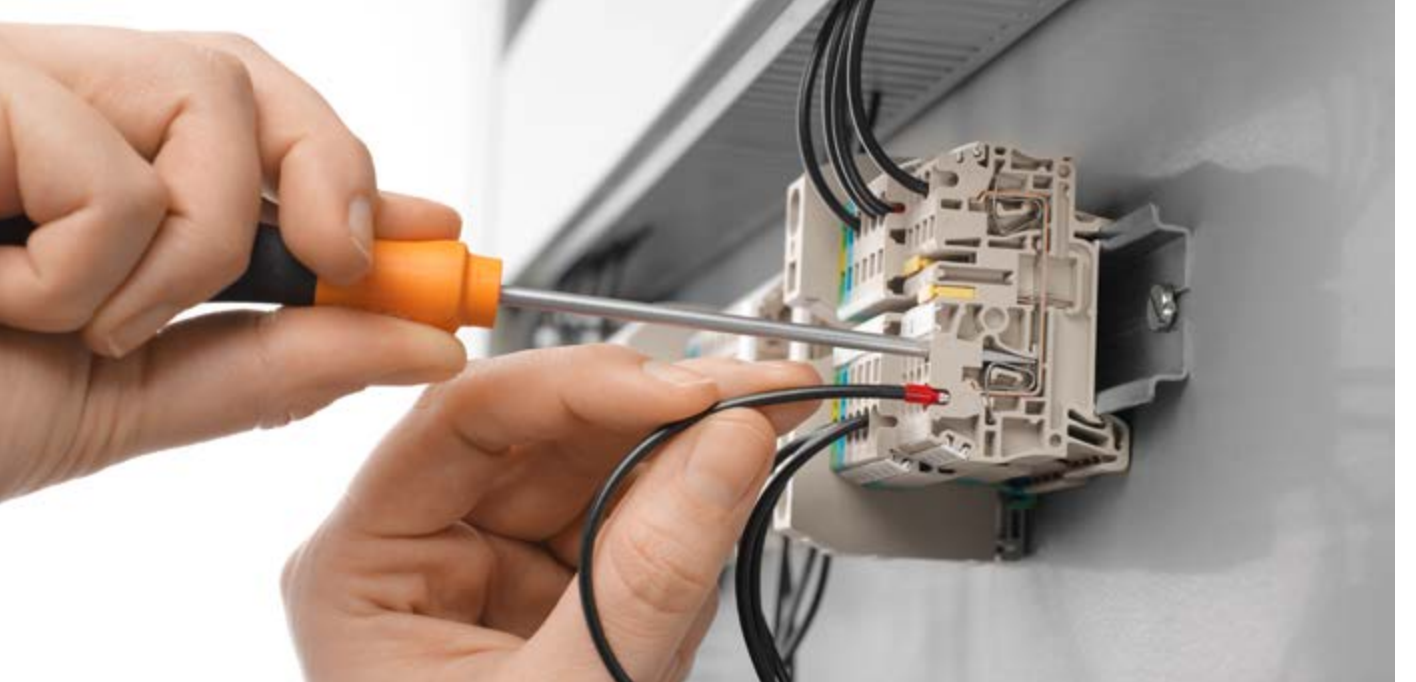



## Z Serisi Ray Klemensleri - Yaylı Bağlantı Teknolojisi



ZDU 2.5



ZDU 2.5 BL



ZDU 35



ZDU 2.5/3AN



ZDK 2.5



ZMAK 2.5



ZPE 2.5

Tip	V / A	Kesit - mm <sup>2</sup> (Yüksüksüz)	Sipariş No	Fiyat/Birim	Ambalaj
<b>Z Serisi Geçiş Klemensleri</b>					
ZDU 2.5	800 / 24	0.5 - 4 mm <sup>2</sup>	1608510000	5,85 TL	100
ZDU 2.5 BL	800 / 24	0.5 - 4 mm <sup>2</sup>	1608520000	5,85 TL	100
ZDU 1.5	500 / 17.5	0.5 - 1.5 mm <sup>2</sup>	1775480000	7,26 TL	100
ZDU 1.5 BL	500 / 17.5	0.5 - 1.5 mm <sup>2</sup>	1775490000	7,26 TL	100
ZDU 4	800 / 32	0.5 - 6 mm <sup>2</sup>	1632050000	7,93 TL	100
ZDU 4 BL	800 / 32	0.5 - 6 mm <sup>2</sup>	1632060000	7,93 TL	100
ZDU 6	800 / 41	1.5 - 10 mm <sup>2</sup>	1608620000	13,35 TL	50
ZDU 6 BL	800 / 41	1.5 - 10 mm <sup>2</sup>	1608630000	13,35 TL	50
ZDU 10	1000 / 57	1.5 - 16 mm <sup>2</sup>	1746750000	19,05 TL	25
ZDU 10 BL	1000 / 57	1.5 - 16 mm <sup>2</sup>	1746760000	19,05 TL	25
ZDU 16	1000 / 76	2.5 - 25 mm <sup>2</sup>	1745230000	25,75 TL	25
ZDU 16 BL	1000 / 76	2.5 - 25 mm <sup>2</sup>	1745240000	25,75 TL	25
ZDU 35	800 / 125	2.5 - 35 mm <sup>2</sup>	1739620000	168,35 TL	10
ZDU 35 BL	800 / 125	2.5 - 35 mm <sup>2</sup>	1739630000	168,35 TL	10

### Renk Tipleri

	Bej	Mavi	Turuncu	Kahverengi	Sarı	Yeşil	Gri	Kırmızı	Siyah	Pembe	Beyaz
ZDU 2.5	160851	160852	163678	168330	168327	168328	168331	168326	168333	168329	168332
ZDU 4	163205	163206	163683	168362	168359	-	168363	168358	168365	-	168364
ZDU 6	160862	160863	163682	-	-	-	-	-	-	-	-
ZDU 10	174675	174676	183061	-	-	-	-	-	-	-	-
ZDU 16	174523	174524	183068	-	-	-	-	-	-	-	-
ZDU 35	173962	173963	183076	-	-	-	-	-	-	-	-

Tip	V / A	Kesit - mm <sup>2</sup> (Yüksüksüz)	Sipariş No	Fiyat/Birim	Ambalaj
<b>İkili Geçiş Klemensleri</b>					
ZDU 2.5/3AN	800 / 24	0.5 - 4 mm <sup>2</sup>	1608540000	12,55 TL	100
ZDU 2.5/4AN	800 / 24	0.5 - 4 mm <sup>2</sup>	1608570000	16,25 TL	100
ZDU 2.5/2X2AN	800 / 24	0.5 - 4 mm <sup>2</sup>	1608600000	26,60 TL	100
ZDU 4/3AN	800 / 32	1.5 - 6 mm <sup>2</sup>	7904180000	18,10 TL	50
ZDU 4/4AN	800 / 32	1.5 - 6 mm <sup>2</sup>	7904290000	21,85 TL	50

### İki Katlı Klemensler

ZDK 1.5	500 / 17.5	0.5 - 1.5 mm <sup>2</sup>	1791100000	16,90 TL	100
ZDK 1.5DU-PE	500 / 17.5	0.5 - 1.5 mm <sup>2</sup>	1791120000	42,45 TL	100
ZDK 2.5	800 / 24	0.5 - 2.5 mm <sup>2</sup>	1674300000	17,35 TL	50
ZDK 2.5DU-PE	800 / 24	0.5 - 2.5 mm <sup>2</sup>	1689970000	61,80 TL	50
ZDK 6S/L/L	800 / 41	1.5 - 6 mm <sup>2</sup>	1733260000	61,80 TL	25

### Üç Katlı Klemensler (Her Üç Kat Köprülenebilir)

ZDLD 2.5-2N	500 / 20	0.5 - 2.5 mm <sup>2</sup>	1782300000	49,00 TL	50
ZDLD 2.5-2N/PE/L/L	500 / 20	0.5 - 2.5 mm <sup>2</sup>	1131750000	84,10 TL	50
ZDLD 2.5-2N/PE/L/N	500 / 20	0.5 - 2.5 mm <sup>2</sup>	1131760000	84,10 TL	50
ZDLD 2.5-2N PE	500 / 20	0.5 - 2.5 mm <sup>2</sup> / Üç Kat Köprülü Toprak	1131740000	93,45 TL	50
ZVLD 2.5	250 / 24	0.5 - 2.5 mm <sup>2</sup> / Dört Katlı Klemens	1208920000	89,15 TL	50
ZMAK 2.5	250 / 24	0.5 - 2.5 mm <sup>2</sup> / Dört Katlı / 3 Faz - 1 PE	1768000000	89,15 TL	25

### Topraklama Klemensleri

ZPE 2.5	800	0.5 - 4 mm <sup>2</sup>	1608640000	26,30 TL	50
ZPE 4	800	0.5 - 6 mm <sup>2</sup>	1632080000	33,65 TL	50
ZPE 6	800	1.5 - 10 mm <sup>2</sup>	1608670000	41,65 TL	50
ZPE 10	800	1.5 - 16 mm <sup>2</sup>	1746770000	52,55 TL	25

Serinin devamı sayfa 15



ZDU 2.5-2



ZEW 15

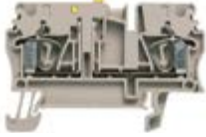

ZTR 2.5



ZSI 2.5



ZSI 2.5-2/2X2AN/G20



ZTR 2.5/0.TNHE



SIHA 3/G20



ZPV 1.5

Tip	V / A	Kesit - mm <sup>2</sup> (Yüksüksüz)	Sipariş No	Fiyat/Birim	Ambalaj
ZPE 16	800	2.5 - 25 mm <sup>2</sup>	1745250000	69,00 TL	25
ZPE 35	800	2.5 - 35 mm <sup>2</sup>	1739650000	271,95 TL	10

#### Z Serisi Mini Klemens

ZDU 2.5-2	500 / 24	0.5 - 2.5 mm <sup>2</sup>	1720920000	14,45 TL	100
ZDU 2.5-2 BL	500 / 24	0.5 - 2.5 mm <sup>2</sup> / Mavi	1720930000	14,45 TL	100

#### Z Serisi Mini Topraklama Klemens

ZPEA 2.5-2	500	0.5 - 2.5 mm <sup>2</sup>	1720950000	28,10 TL	100
------------	-----	---------------------------	------------	----------	-----

Tip	Açıklama	Sipariş No	Fiyat/Birim	Ambalaj
-----	----------	------------	-------------	---------

#### Mini Klemens Durdurucuları

ZEW 15	Vidasız Durdurucu	7920340000	6,18 TL	20
--------	-------------------	------------	---------	----

Tip	V / A	Kesit - mm <sup>2</sup> (Yüksüksüz)	Sipariş No	Fiyat/Birim	Ambalaj
-----	-------	-------------------------------------	------------	-------------	---------

#### Ölçme Ayırma Klemensleri

ZTR 2.5	500 / 20	0.5 - 4 mm <sup>2</sup>	1831280000	41,65 TL	50
ZTR 2.5/3AN	500 / 20	0.5 - 4 mm <sup>2</sup>	8731720000	38,90 TL	50
ZDTR 2.5	400 / 16	0.5 - 4 mm <sup>2</sup> / İki Kat / İki Kat Ayırma	1745400000	114,35 TL	20
ZTD 6	800 / 41	1.5 - 6 mm <sup>2</sup> / Direk Besleme	1771810000	66,25 TL	20
ZTD 6/STB	800 / 41	1.5 - 6 mm <sup>2</sup> / Direk Besleme / Test Soket	1771960000	61,05 TL	20
ZTL 6	800 / 41	1.5 - 6 mm <sup>2</sup> / Sürgü Ayırma	1771800000	69,00 TL	20
ZTL 6/STB	800 / 41	1.5 - 6 mm <sup>2</sup> / Sürgü Ayırma / Test Soket	1771950000	96,45 TL	20

#### Sigortalı Klemensler ve Modüller

ZSI 2.5	500 / 6.3	0.5 - 4 mm <sup>2</sup> / 5X20 Sigorta	1616400000	51,80 TL	50
ZSI 2.5/5X25	500 / 6.3	0.5 - 4 mm <sup>2</sup> / 5X25 Sigorta	1730900000	55,40 TL	50
ZSI 2.5-2/2X2AN/G20	500 / 27	0.5 - 4 mm <sup>2</sup> / 5X25 Sigorta / Hazardous Bölge	1826050000	96,45 TL	20
ZSI 6-2 2X2.5/G20	500 / 24	0.5 - 4 mm <sup>2</sup> / 5X25 Sigorta / Hazardous Bölge	1820930000	96,45 TL	20
ZSI 2.5-2/2X2AN/G20/LD4	500 / 10	0.5 - 4 mm <sup>2</sup> / 5X25 Sigorta / Hazardous Bölge / Led	1879730000	132,45 TL	20
ZSI 6-2 2X2.5/G20/LD4	500 / 10	0.5 - 4 mm <sup>2</sup> / 5X25 Sigorta / Hazardous Bölge / Led	1879750000	130,95 TL	20
ZSI 6-2/FC	250 / 30	0.5 - 10 mm <sup>2</sup> / Oto Sigorta Tip Klemens	1814690000	123,05 TL	25
ZSI 6-2/FC LD	250 / 30	0.5 - 10 mm <sup>2</sup> / Oto Sigorta Tip Klemens / Led	1814700000	166,95 TL	25
ZTR 2.5/0.TNHE	500 / 20	SIHA ve BEST modül için	1831130000	36,60 TL	50
ZDL 2.5/SI/DU	500 / 20	SIHA ve BEST modül için / İki Katlı / Üst Kat Sigortalı	1763180000	96,45 TL	25
SIHA 3/G20	250 / 6.3	Sigorta Modül	7921560000	35,95 TL	25
SIHA 3/G20/LD 10-36V	10 - 36	10-36V AC-DC Led Sigorta Modül	7921570000	78,40 TL	25
SIHA 3/G20/LD 140-250V	140 - 250	140-250V Led Sigorta Modül	7921600000	84,80 TL	25
BEST	250	Boş Modül	1833100000	59,00 TL	50
BEST/DRBR	400 / 41	Jumper Modül	1878570000	75,55 TL	50
BEST/D	Max 250	WTR 2.5/ 1N4007 diyotlu fiş	1878560000	78,40 TL	50

#### Sigortalar

G 20/0.25A/F	0.25	Sigorta	0430500000	13,55 TL	10
G 20/0.50A/F	0.5	Sigorta	0430600000	15,70 TL	10
G 20/1.00A/F	1	Sigorta	0430700000	13,55 TL	10
G 20/2.00A/F	2	Sigorta	0430900000	13,55 TL	10

#### Sensör - Aktüatörler İçin Köprü Gerektirmeyen Modüler Yaylı Klemensler

ZPV 1.5	250 / 17.5	Dört Bölüm Boş Taban	1676630000	10,55 TL	100
ZIA 1.5/3L-1S	250 / 17.5	0.5 - 2.5 mm <sup>2</sup> / İki Bölüm / İkili Geçiş	1651980000	23,05 TL	100
ZIA 1.5/3L-1S/LD-RT	250 / 17.5	0.5 - 2.5 mm <sup>2</sup> / İki Bölüm / İkili Geçiş / Led	1651990000	70,50 TL	50
ZIA 1.5/3L-PE	250 / 17.5	0.5 - 2.5 mm <sup>2</sup> / İki Bölüm / Toprak	1652000000	104,95 TL	20
ZIA 1.5/4L-1S	250 / 17.5	0.5 - 2.5 mm <sup>2</sup> / Üç Bölüm / İkili Geçiş	1652010000	24,45 TL	100
ZIA 1.5/4L-1S/LD	250 / 17.5	0.5 - 2.5 mm <sup>2</sup> / Üç Bölüm / İkili Geçiş / Led	1652020000	55,40 TL	50
ZIA 1.5/4L-PE	250 / 17.5	0.5 - 2.5 mm <sup>2</sup> / Üç Bölüm / Toprak	1652030000	104,95 TL	20

Serinin devamı sayfa 16

## Z Serisi Ray Klemensleri - Yaylı Bağlantı Teknolojisi



ZVL 1.5



ZEW 35



ZAP/TW 1



ZAP/TW ZDU1.5/2AN



ZAP/TW 3



ZQV 1.5/2



ZQV 1.5/4



ZQV 2.5/2

Tip	V / A	Kesit - mm <sup>2</sup> (Yüksüksüz)	Sipariş No	Fiyat/Birim	Ambalaj
ZVL 1.5	250 / 17.5	0.5 - 2.5 mm <sup>2</sup> / Dağıtım Klemens	1649300000	10,55 TL	100
ZVL 1.5 BL	250 / 17.5	0.5 - 2.5 mm <sup>2</sup> / Dağıtım Klemens / Mavi	1650360000	12,55 TL	100
ZVL 1.5 BR	250 / 17.5	0.5 - 2.5 mm <sup>2</sup> / Dağıtım Klemens / Kahverengi	1650370000	12,55 TL	100
ZVL 1.5 0.QV	250 / 17.5	0.5 - 2.5 mm <sup>2</sup> / Dağıtım Klemens	1711930000	12,90 TL	100
ZVL 1.5/PE GN/GE BED	250 / 17.5	0.5 - 2.5 mm <sup>2</sup> / Dağıtım Klemens / Toprak	1651970000	12,55 TL	100

Tip	Açıklama	Sipariş No	Fiyat/Birim	Ambalaj
<b>Klemens Durdurucuları</b>				
ZEW 35	Vidasız Tip 6mm Kalınlık	9540000000	6,79 TL	20
ZEW 35/2	Vidasız Tip 8mm Kalınlık	8630740000	7,73 TL	20
ZEW 35/2 SW	Vidasız Tip 8mm Kalınlık Siyah	1162610000	8,67 TL	20

<b>Nihayet Plakaları</b>				
ZAP/TW 1	ZDU 2.5	1608740000	5,44 TL	50
ZAP/TW 1 BL	ZDU 2.5 Mavi Serisi	1608750000	5,44 TL	50
ZAP/TW ZDU1.5/2AN	ZDU 1.5 Serisi	1776030000	4,91 TL	20
ZAP/TW ZDU1.5/2AN BL	ZDU 1.5 Mavi Serisi	1776040000	4,91 TL	20
ZAP/TW 4	ZDU 4 Serisi	1632090000	5,44 TL	50
ZAP/TW 4 BL	ZDU 4 Mavi Serisi	1632100000	5,44 TL	50
ZAP/TW 5	ZDU 6 Serisi	1608830000	5,44 TL	50
ZAP/TW 5 BL	ZDU 6 Mavi Serisi	1608840000	5,44 TL	50
ZAP/TW ZDU10	ZDU 10 Serisi	1748660000	6,12 TL	20
ZAP/TW ZDU10 BL	ZDU 10 Mavi Serisi	1764110000	6,12 TL	20
ZAP/TW ZDU16	ZDU 16 Serisi	1745150000	8,67 TL	20
ZAP/TW ZDU16 BL	ZDU 16 Mavi Serisi	1764100000	8,67 TL	20
ZAP/TW ZDK1.5	ZDK 1.5 Serisi	1791160000	5,51 TL	20
ZAP/TW ZDK2.5	ZDK 2.5 Serisi	1674730000	11,20 TL	20
ZAP/TW ZDK2.5 BL	ZDK 2.5 Mavi Serisi	1748800000	11,20 TL	20
ZAP/TW ZDL2.5-2N	ZDL 2.5 Serisi	1782340000	8,67 TL	20
ZAP ZVLD 2.5	ZVLD 2.5 Serisi	1210410000	8,48 TL	10
ZAP ZMAK2.5	ZMAK 2.5 Serisi	1768010000	13,65 TL	10
ZAP/TW 2 DB	ZTR 2.5 - ZDU 2.5/3 AN Serisi	1608770000	6,12 TL	50
ZAP/TW 3	ZSI 2.5 - ZDU 2.5/4 AN Serisi	1608800000	6,12 TL	50
ZAP/TW 4/3AN	ZDU 4/3AN Serisi	7904100000	8,33 TL	20
ZAP/TW4/4AN	ZDU 4/4AN Serisi	7904210000	8,33 TL	20
ZAP TNHE/ZSI2.5	ZSI 2.5 Serisi Sigorta Kapağı	1610840000	5,11 TL	25
ZAP ZDL2.5	ZDL 2.5 Serisi	1720910000	9,54 TL	20
ZTW ZTL6	ZTL 6 Serisi	1771870000	15,10 TL	20
ZAP/TW ZPV1.5	ZPV 1.5 Serisi	1674650000	7,46 TL	50
ZAP/TW ZIA1.5/3L	ZIA 1.5/3L Serisi	1649540000	8,67 TL	50
ZAP/TW ZIA1.5/4L	ZIA 1.5/4L Serisi	1649550000	8,67 TL	50
ZAP/TW ZDUA	ZDUA Serisi	1720960000	3,49 TL	50
ZAP/TW ZDUA BL	ZDUA Mavi Serisi	1720970000	3,49 TL	50

Tip	A	Kutup Sayısı	Sipariş No	Fiyat/Birim	Ambalaj
<b>Z Serisi Klemens Üst Köprü</b>					
ZQV 1.5/2	17.5	2 Kutup / ZDU 1.5 - ZDK 1.5 - ZEI 6 Seri	1776120000	5,11 TL	60
ZQV 1.5/3	17.5	3 Kutup / ZDU 1.5 - ZDK 1.5 - ZEI 6 Seri	1776130000	10,15 TL	60
ZQV 1.5/4	17.5	4 Kutup / ZDU 1.5 - ZDK 1.5 - ZEI 6 Seri	1776140000	13,65 TL	60
ZQV 1.5/5	17.5	5 Kutup / ZDU 1.5 - ZDK 1.5 - ZEI 6 Seri	1776150000	17,20 TL	20
ZQV 1.5/10	17.5	10 Kutup / ZDU 1.5 - ZDK 1.5 - ZEI 6 Seri	1776200000	43,90 TL	20
ZQV 2.5/2	24	2 Kutup / ZDU 2.5 - ZDK 2.5 - ZTR 2.5 Seri	1608860000	4,91 TL	60
ZQV 2.5/3	24	3 Kutup / ZDU 2.5 - ZDK 2.5 - ZTR 2.5 Seri	1608870000	8,74 TL	60

Serinin devamı sayfa 17



Tip	A	Kutup Sayısı	Sipariş No	Fiyat/Birim	Ambalaj
ZQV 2.5/4	24	4 Kutup / ZDU 2.5 - ZDK 2.5 - ZTR 2.5 Seri	1608880000	12,00 TL	60
ZQV 2.5/5	24	5 Kutup / ZDU 2.5 - ZDK 2.5 - ZTR 2.5 Seri	1608890000	17,20 TL	20
ZQV 2.5/6	24	6 Kutup / ZDU 2.5 - ZDK 2.5 - ZTR 2.5 Seri	1608900000	21,50 TL	20
ZQV 2.5/7	24	7 Kutup / ZDU 2.5 - ZDK 2.5 - ZTR 2.5 Seri	1608910000	25,50 TL	20
ZQV 2.5/8	24	8 Kutup / ZDU 2.5 - ZDK 2.5 - ZTR 2.5 Seri	1608920000	29,45 TL	20
ZQV 2.5/9	24	9 Kutup / ZDU 2.5 - ZDK 2.5 - ZTR 2.5 Seri	1608930000	33,70 TL	20
ZQV 2.5/10	24	10 Kutup / ZDU 2.5 - ZDK 2.5 - ZTR 2.5 Seri	1608940000	34,35 TL	20
ZQV 2.5/20	24	20 Kutup / ZDU 2.5 - ZDK 2.5 - ZTR 2.5 Seri	1908960000	79,85 TL	20
ZQV 4/2 GE	32	2 Kutup / ZDU 4 - ZDK 4/S - ZEI 6 Seri	1608950000	5,51 TL	60
ZQV 4/3 GE	32	3 Kutup / ZDU 4 - ZDK 4/S - ZEI 6 Seri	1608960000	9,54 TL	60
ZQV 4/4 GE	32	4 Kutup / ZDU 4 - ZDK 4/S - ZEI 6 Seri	1608970000	12,30 TL	60
ZQV 4/5 GE	32	5 Kutup / ZDU 4 - ZDK 4/S - ZEI 6 Seri	1608980000	18,20 TL	20
ZQV 4/6 GE	32	6 Kutup / ZDU 4 - ZDK 4/S - ZEI 6 Seri	1608990000	23,05 TL	20
ZQV 4/7 GE	32	7 Kutup / ZDU 4 - ZDK 4/S - ZEI 6 Seri	1609000000	27,35 TL	20
ZQV 4/8 GE	32	8 Kutup / ZDU 4 - ZDK 4/S - ZEI 6 Seri	1609010000	31,70 TL	20
ZQV 4/9 GE	32	9 Kutup / ZDU 4 - ZDK 4/S - ZEI 6 Seri	1609020000	36,60 TL	20
ZQV 4/10 GE	32	10 Kutup / ZDU 4 - ZDK 4/S - ZEI 6 Seri	1609030000	38,25 TL	20
ZQV 4/20 GE	32	20 Kutup / ZDU 4 - ZDK 4/S - ZEI 6 Seri	1909010000	84,80 TL	20
ZQV 6/2 GE	41	2 Kutup / ZDU 6 - ZDK 6/S - ZTL 6 Seri	1627850000	8,74 TL	60
ZQV 6/3 GE	41	3 Kutup / ZDU 6 - ZDK 6/S - ZTL 6 Seri	1627860000	15,85 TL	60
ZQV 6/4 GE	41	4 Kutup / ZDU 6 - ZDK 6/S - ZTL 6 Seri	1627870000	25,50 TL	60
ZQV 6/24 GE	41	24 Kutup / ZDU 6 - ZDK 6/S - ZTL 6 Seri	1908990000	116,55 TL	10
ZQV 10/2	57	2 Kutup / ZDU 10 Seri	1739680000	15,85 TL	25
ZQV 16/2	76	2 Kutup / ZDU 16 - ZPE 16 Seri	1739690000	16,50 TL	25
ZQV 35/2	125	2 Kutup / ZDU 35 - ZPE 35 Seri	1739700000	21,50 TL	10
ZQV 2.5N/2 GE	24	2 Kutup	1693800000	5,51 TL	60
ZQV 2.5N/3 GE	24	3 Kutup	1693810000	9,54 TL	60
ZQV 2.5N/4 GE	24	4 Kutup	1693820000	13,65 TL	60
ZQV 2.5N/5 GE	24	5 Kutup	1693830000	16,90 TL	20
ZQV 2.5N/6 GE	24	6 Kutup	1693840000	21,40 TL	20
ZQV 2.5N/7 GE	24	7 Kutup	1693850000	25,50 TL	20
ZQV 2.5N/8 GE	24	8 Kutup	1693860000	29,60 TL	20
ZQV 2.5N/9 GE	24	9 Kutup	1693870000	33,70 TL	20
ZQV 2.5N/10 GE	24	10 Kutup	1693880000	38,25 TL	20
ZVQ 2.5/1.5	24	ZDK 2,5 ve ZDLD için iki kat arası köprü	1720700000	9,54 TL	50

## Klippon Connect PUSH IN Klemens Serisi

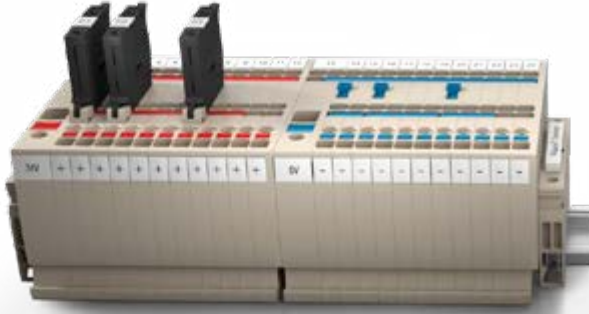

## Klippon Connect PUSH-IN Klemens Serisi

**Klippon® Connect'in size tüm pano yapım aşamalarında sunabileceği avantajları keşfedin.**

Özel tasarlanmış işlevsel modüller ve PUSH IN teknolojisi sadece daha kısa planlama ve kurulum süreleri sağlamakla kalmaz, aynı zamanda Weidmüller Configurator ile sizlere dijital pano planlaması için gerekli ideal yazılım arayüzünü de sunar. Ayrıca entegre test noktası gibi ürün özellikleri, işletim sırasında verimliliği artırmaya somut bir şekilde yardımcı olur.

Size olağanüstü avantajlar sunabilmek için ürünlerimizi en küçük ayrıntılarına kadar titizlikle tasarladık. Bu nedenle A-Serisi Klippon® Connect klemens bloklarımız benzerlerinden bir dizi önemli noktada ayrılarak öne çıkıyor. Yepyeni bir kazanımı ayrıntılı olarak inceleyin ve geniş kullanım avantajlarını keşfedin.



- Push-in bağlantı teknolojisi
- Kurulum için harcanan zamandan %50'ye varan oranda tasarruf
- Basit modifikasyon ve uzatma
- Daha hızlı bakım çalışması

PUSH IN teknolojisine sahip üniversal klemens bloklarımız kullanıcılarına üretim sürelerini minimize ederek maksimum kazanç sağlar. Sistem modifikasyonları veya genişlemeler gibi yeniden kablolama gerektiren durumlarda el aleti kullanmaksızın montaj imkanı sunar. Push-in bağlantı teknolojisinin sunduğu yaylı tutunma sistemi sayesinde vibrasyonlara karşı stabil bir yapı oluşturulur ve maksimum ölçüde bağlantı güvenliği sağlanmış olur.



## Klippon Connect PUSH IN Klemens Serisi



A2C 2.5



A2C 16



A2C 50/70



A2C 50/70 BL



A3C 1.5



A3C 2.5



A3C 6 BL



A2T 2.5

Tip	V / A	Kesit - mm <sup>2</sup> (Yüksüksüz)	Sipariş No	Fiyat/Birim	Ambalaj
<b>Geçiş Klemensleri</b>					
A2C 2.5	800/24	2.5 mm <sup>2</sup>	1521850000	5,88 TL	100
A2C 2.5 BL	800/24	2.5 mm <sup>2</sup>	1521880000	5,88 TL	100
A2C 1.5	500/17.5	1.5 mm <sup>2</sup>	1552790000	8,12 TL	100
A2C 1.5 BL	500/17.5	1.5 mm <sup>2</sup>	1552820000	8,12 TL	100
A2C 4	800/32	4 mm <sup>2</sup>	2051180000	9,82 TL	100
A2C 4 BL	800/32	4 mm <sup>2</sup>	2051210000	9,82 TL	100
A2C 6	800/41	6 mm <sup>2</sup>	1992110000	13,55 TL	50
A2C 6 BL	800/41	6 mm <sup>2</sup>	1991790000	13,55 TL	50
ALO 6	800/41	6 mm <sup>2</sup>	1991780000	37,25 TL	20
ALO 6 BL	800/41	6 mm <sup>2</sup>	2065120000	37,25 TL	20
A2C 10	1000/57	10 mm <sup>2</sup>	2490360000	25,65 TL	25
A2C 10 BL	1000/57	10 mm <sup>2</sup>	2490370000	25,65 TL	25
A2C 16	1000/76	16 mm <sup>2</sup>	2494000000	32,55 TL	20
A2C 16 BL	1000/76	16 mm <sup>2</sup>	2494100000	32,55 TL	20
A2C 35	1000/125	35 mm <sup>2</sup>	2551510000	55,35 TL	10
A2C 35 BL	1000/125	35 mm <sup>2</sup>	2552090000	55,35 TL	10
* A2C 50/70	1000/150	50/70 mm <sup>2</sup>	2663250000	156,80 TL	5
* A2C 50/70 BL	1000/150	50/70 mm <sup>2</sup>	2663260000	156,80 TL	5

### Renk Tipleri

Bej	Mavi	Turuncu	Kahverengi	Sarı	Yeşil	Gri	Kırmızı	Siyah	Lacivert	Beyaz

A2C 2.5	152185	152188	152193	250803	152194	152195	200311	152190	152198	250800	152197
A2C 4	205118	205121	205123	253437	205125	205126	205133	205122	205131	253438	205129
A2C 6	199211	199179	199180	-	-	-	-	-	-	-	-

Tip	V / A	Kesit - mm <sup>2</sup> (Yüksüksüz)	Sipariş No	Fiyat/Birim	Ambalaj
<b>1 Giriş - 2 Çıkış İkilili Geçiş Klemensleri</b>					
A3C 1.5	500/17.5	1.5 mm <sup>2</sup>	1552740000	10,90 TL	50
A3C 1.5 BL	500/17.5	1.5 mm <sup>2</sup>	1552770000	10,90 TL	50
A3C 2.5	800/24	2.5 mm <sup>2</sup>	1521740000	11,70 TL	100
A3C 2.5 BL	800/24	2.5 mm <sup>2</sup>	1521780000	11,70 TL	100
A3C 4	800/32	4 mm <sup>2</sup>	2051240000	19,65 TL	50
A3C 4 BL	800/32	4 mm <sup>2</sup>	2051280000	19,65 TL	50
A3C 6	800/41	6 mm <sup>2</sup>	1991820000	26,30 TL	50
A3C 6 BL	800/41	6 mm <sup>2</sup>	1991830000	26,30 TL	50
A3C 10	1000/57	10 mm <sup>2</sup>	2490520000	40,40 TL	25
A3C 10 BL	1000/57	10 mm <sup>2</sup>	2490510000	40,40 TL	25

<b>2 Giriş - 2 Çıkış İkilili Geçiş Klemensleri</b>					
A4C 1.5	500/17.5	1.5 mm <sup>2</sup>	1552690000	11,40 TL	100
A4C 1.5 BL	500/17.5	1.5 mm <sup>2</sup>	1552700000	11,40 TL	100
A4C 2.5	800/24	2.5 mm <sup>2</sup>	1521690000	15,45 TL	100
A4C 2.5 BL	800/24	2.5 mm <sup>2</sup>	1521700000	15,45 TL	100
A4C 4	800/32	4 mm <sup>2</sup>	2051500000	18,75 TL	50
A4C 4 BL	800/32	4 mm <sup>2</sup>	2051520000	18,75 TL	50

<b>İki Katlı Klemensler</b>					
A2T 1.5	500/17.5	1.5 mm <sup>2</sup>	2469370000	16,85 TL	50
A2T 1.5 BL	500/17.5	1.5 mm <sup>2</sup>	2471430000	16,85 TL	50
A2T 2.5	800/24	2.5 mm <sup>2</sup>	1547610000	17,35 TL	50
A2T 2.5 BL	800/24	2.5 mm <sup>2</sup>	1547620000	21,85 TL	50

Serinin devamı sayfa 21



A2T 4 BL



A2T 2.5 VL BL



A3T 2.5



AMC 2.5



A2C 2.5 PE

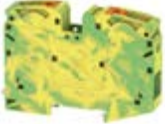

A2C 35 PE

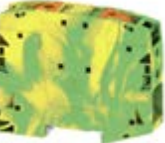

A2C 50/70 PE



A2T 4 PE



ADT 2.5 2C BL

Tip	V / A	Kesit - mm <sup>2</sup> (Yüksüksüz)	Sipariş No	Fiyat/Birim	Ambalaj
A2T 4	800/32	4 mm <sup>2</sup>	2539970000	26,30 TL	50
A2T 4 BL	800/32	4 mm <sup>2</sup>	2540040000	26,30 TL	50
<b>İki Katlı Köprülü Klemensler</b>					
A2T 1.5 VL	500/17.5	1.5 mm <sup>2</sup>	2469400000	37,85 TL	50
A2T 1.5 VL BL	500/17.5	1.5 mm <sup>2</sup>	2471450000	37,85 TL	50
A2T 2.5 VL	800/24	2.5 mm <sup>2</sup>	1547650000	34,85 TL	50
A2T 2.5 VL BL	800/24	2.5 mm <sup>2</sup>	1547660000	34,85 TL	50
<b>Üç Katlı Klemensler</b>					
A3T 2.5	800/24	2.5 mm <sup>2</sup>	2428510000	46,50 TL	50
A3T 2.5 BL	800/24	2.5 mm <sup>2</sup>	2428520000	46,50 TL	50
A3T 2.5 VL	800/24	2.5 mm <sup>2</sup>	2428540000	76,25 TL	25
A3T 2.5 FT-FT-PE	800/24	2.5 mm <sup>2</sup>	2428530000	76,25 TL	50
A3T 2.5 N-FT-PE	800/24	2.5 mm <sup>2</sup>	2428840000	76,25 TL	50
<b>Dört Katlı Klemensler</b>					
AMC 2.5	690/22	2.5 mm <sup>2</sup>	2434340000	81,05 TL	50
AMC 2.5 800 V	800/22	2.5 mm <sup>2</sup>	2434370000	89,45 TL	50
<b>Topraklama Klemensleri</b>					
A2C 1.5 PE	500	1.5 mm <sup>2</sup>	1552680000	28,95 TL	50
A2C 2.5 PE	800	2.5 mm <sup>2</sup>	1521680000	22,30 TL	50
A2C 4 PE	800	4 mm <sup>2</sup>	2051360000	27,40 TL	50
A2C 6 PE	800	6 mm <sup>2</sup>	1991810000	39,85 TL	50
A2C 10 PE	1000	10 mm <sup>2</sup>	2490440000	55,95 TL	25
A2C 16 PE	1000	16 mm <sup>2</sup>	2494010000	62,95 TL	20
A2C 35 PE	1000	35 mm <sup>2</sup>	2551520000	86,90 TL	10
* A2C 50/70 PE	1000	50/70 mm <sup>2</sup>	2663280000	336,00 TL	5
<b>İki ve Üç Katlı Toprak Klemensler</b>					
A2T 1.5 PE	500	1.5 mm <sup>2</sup>	2469410000	59,75 TL	50
A2T 2.5 PE	800	2.5 mm <sup>2</sup>	1547680000	74,20 TL	50
A2T 4 PE	800	4 mm <sup>2</sup>	2539990000	78,40 TL	50
A3T 2.5 PE	800	2.5 mm <sup>2</sup>	2428550000	96,50 TL	50
<b>1 Giriş - 2 Çıkış Topraklama Klemensleri</b>					
A3C 1.5 PE	500	1.5 mm <sup>2</sup>	1552670000	46,60 TL	50
A3C 2.5 PE	800	2.5 mm <sup>2</sup>	1521670000	38,25 TL	50
A3C 4 PE	800	4 mm <sup>2</sup>	2051410000	51,65 TL	50
A3C 6 PE	800	6 mm <sup>2</sup>	1991850000	62,20 TL	50
A3C 10 PE	1000	10 mm <sup>2</sup>	2490590000	81,55 TL	25
A3C 16 PE	1000	16 mm <sup>2</sup>	2494020000	94,85 TL	20
<b>2 Giriş - 2 Çıkış Topraklama Klemensleri</b>					
A4C 1.5 PE	500	1.5 mm <sup>2</sup>	1552660000	38,55 TL	50
A4C 2.5 PE	800	2.5 mm <sup>2</sup>	1521540000	53,20 TL	50
A4C 4 PE	800	4 mm <sup>2</sup>	2051560000	51,65 TL	50
<b>Ölçme Ayırma Klemensleri</b>					
ADT 2.5 2C	400/20	2.5 mm <sup>2</sup> / Test Ayırma	1989800000	35,35 TL	50
ADT 2.5 2C BL	400/20	2.5 mm <sup>2</sup> / Test Ayırma	1989810000	35,35 TL	50
ADT 4 2C	400/20	4 mm <sup>2</sup> / Test Ayırma	2429850000	51,80 TL	50
ADT 4 2C BL	400/20	4 mm <sup>2</sup> / Test Ayırma	2429880000	51,80 TL	50
ADT 2.5 3C	400/20	2.5 mm <sup>2</sup> / Test Ayırma 1 Giriş-2 Çıkış	1989830000	37,40 TL	50
ADT 2.5 4C	400/20	2.5 mm <sup>2</sup> / Test Ayırma 2 Giriş-2 Çıkış	1989860000	42,90 TL	50
ADT 2.5 2C W/O DTLV	400/20	2.5 mm <sup>2</sup> / Test Ayırma Sigorta Modüllü	1989930000	31,70 TL	50

Serinin devamı sayfa 22



## Klippon Connect PUSH IN Klemens Serisi



AFS 2.5 CF 2C BK



AFS 2.5 CF 2C 24V BK



AEB 35 SC/1



AEP 2C 1.5



AEP 3C 1.5

Tip	V / A	Kesit - mm <sup>2</sup> (Yüksüksüz)	Sipariş No	Fiyat/Birim	Ambalaj
ADT 2.5 3C W/O DTLV	400/20	2.5 mm <sup>2</sup> / Test Ayırma Sigorta Modüllü 1 Giriş - 2 Çıkış	1989940000	35,75 TL	50
ADT 2.5 4C W/O DTLV	400/20	2.5 mm <sup>2</sup> / Test Ayırma Sigorta Modüllü 2 Giriş - 2 Çıkış	1989950000	40,90 TL	50

### Sigortalı Klemensleri

AFS 2.5 CF 2C BK	500/10	2.5 mm <sup>2</sup> / LED'siz, Oto Sigortalı	2466530000	36,45 TL	50
AFS 2.5 CF 2C 12V BK	500/10	2.5 mm <sup>2</sup> / LED'li, Oto Sigortalı	2466610000	84,40 TL	50
AFS 2.5 CF 2C 24V BK	500/10	2.5 mm <sup>2</sup> / LED'li, Oto Sigortalı	2466600000	76,40 TL	50
AFS 4 2C BK	500/6.3	4 mm <sup>2</sup> / LED'siz, 5x20 Cam Sigortalı	2429860000	56,90 TL	50
AFS 4 2C 10-36V BK	500/6.3	4 mm <sup>2</sup> / LED'li, 5x20 Cam Sigortalı	2429870000	136,45 TL	50
AFS 4 2C 30-70V BK	500/6.3	4 mm <sup>2</sup> / LED'li, 5x20 Cam Sigortalı	2434350000	136,45 TL	50
AFS 4 2C 60-150V BK	500/6.3	4 mm <sup>2</sup> / LED'li, 5x20 Cam Sigortalı	2434380000	136,45 TL	50
AFS 4 2C 100-250V BK	500/6.3	4 mm <sup>2</sup> / LED'li, 5x20 Cam Sigortalı	2434390000	136,45 TL	50

Tip	Açıklama	Sipariş No	Fiyat/Birim	Ambalaj
<b>Durdurucular</b>				
AEB 35 SC/1	Klemens durdurucu	1991920000	6,65 TL	50
ZEW 35/2	Vidasız Tip 8mm Kalınlık	8630740000	7,73 TL	20

Tip	Renk	Açıklama	Sipariş No	Fiyat/Birim	Ambalaj
<b>Sonlandırma ve Ayırma Plakaları</b>					
AEP 2C 1.5	Bej	A2C 1.5 Serisi	1552600000	5,44 TL	50
AEP 2C 1.5 BL	Mavi	A2C 1.5 Serisi	1552610000	5,44 TL	50
AEP 3C 1.5	Bej	A3C 1.5 PE Serisi	1552620000	6,72 TL	50
AEP 4C 1.5	Bej	A4C 1.5 Serisi	1552640000	5,51 TL	50
AEP 4C 1.5 BL	Mavi	A4C 1.5 Serisi	1552650000	5,51 TL	50
AEP 2C 2.5	Bej	A2C 2.5 Serisi	1514400000	5,51 TL	50
AEP 2C 2.5 BL	Mavi	A2C 2.5 Serisi	1514420000	5,51 TL	50
AEP 3C 2.5	Bej	A3C 2.5 Serisi	1521510000	5,58 TL	50
AEP 3C 2.5 BL	Mavi	A3C 2.5 Serisi	1521520000	5,58 TL	50
AEP 4C 2.5	Bej	A4C 2.5 Serisi	1521530000	5,71 TL	50
AEP 4C 2.5 BL	Mavi	A4C 2.5 Serisi	1521640000	5,71 TL	50
AEP 3C 4	Bej	A3C 4 Serisi	2051720000	8,94 TL	20
AEP 3C 4 BL	Mavi	A3C 4 Serisi	2051880000	8,94 TL	20
AEP 2C 4	Bej	A2C 4 Serisi	2051680000	6,18 TL	50
AEP 2C 4 BL	Mavi	A2C 4 Serisi	2051690000	6,18 TL	50
AEP 4C 4	Bej	A4C 4 Serisi	2051900000	7,93 TL	20
AEP 4C 4 BL	Mavi	A4C 4 Serisi	2051910000	7,93 TL	20
AEP 2C 6	Bej	A2C 6 Serisi	1991970000	8,40 TL	50
AEP 2C 6 BL	Mavi	A2C 6 Serisi	1991950000	8,40 TL	50
AEP 3C 6	Bej	A3C 6 Serisi	1991940000	8,74 TL	50
AEP 3C 6 BL	Mavi	A3C 6 Serisi	1991910000	8,74 TL	20
AEP 2C 10/16		A2C 10/16 Serisi	2490380000	9,95 TL	20
AEP 2C 10/16 BL		A2C 10/16 Serisi	2490390000	9,95 TL	20
AEP 3C 10/16		A3C 10/16 Serisi	2490530000	10,50 TL	20
AEP 3C 10/16 BL		A3C 10/16 Serisi	2490540000	10,50 TL	20
AEP 2T 2.5	Bej	A2T 2.5 Serisi	1547690000	6,12 TL	20
AEP 2T 2.5 BL	Mavi	A2T 2.5 Serisi	1547700000	6,12 TL	20
AEP 3T 2.5	Bej	A3T 2.5 Serisi	2428560000	10,15 TL	20
AEP 3T 2.5 BL	Mavi	A3T 2.5 Serisi	2428860000	10,15 TL	20
AEP MC 2.5	Bej	AMC 2.5 Serisi	2433820000	10,15 TL	25
AEP DT 2.5 3C	Bej	ADT 2.5 3CW/O DTLV	1989970000	6,12 TL	50
AEP DT 2.5 4C	Bej	ADT 2.5 4C Serisi	1989980000	6,18 TL	50
AEP 4C 2.5 BK	Siyah	AFS 2.5 CF 2C Serisi	2486660000	7,46 TL	50

Serinin devamı sayfa 23



ZQV 1.5N/2



ZQV 1.5N/4



ZQV 2.5N/50



ZQV 4N/4

Tip	Renk	Açıklama	Sipariş No	Fiyat/Birim	Ambalaj
AEP 3C 4 BK	Siyah	AFS 4 2C Serisi	2486640000	9,27 TL	20
Tip	Kutup	Açıklama	Sipariş No	Fiyat/Birim	Ambalaj
Üst Köprüler					
ZQV 1.5N/2	2-pole	A serisi 1.5mm <sup>2</sup> için	1985410000	5,44 TL	60
ZQV 1.5N/3	3-pole	A serisi 1.5mm <sup>2</sup> için	1985480000	9,54 TL	60
ZQV 1.5N/4	4-pole	A serisi 1.5mm <sup>2</sup> için	1985490000	14,15 TL	60
ZQV 1.5N/5	5-pole	A serisi 1.5mm <sup>2</sup> için	1985500000	18,70 TL	20
ZQV 1.5N/6	6-pole	A serisi 1.5mm <sup>2</sup> için	1985510000	23,85 TL	20
ZQV 1.5N/7	7-pole	A serisi 1.5mm <sup>2</sup> için	1985520000	28,80 TL	20
ZQV 1.5N/8	8-pole	A serisi 1.5mm <sup>2</sup> için	1985540000	33,65 TL	20
ZQV 1.5N/9	9-pole	A serisi 1.5mm <sup>2</sup> için	1985560000	38,30 TL	20
ZQV 1.5N/10 OR	10-pole	A serisi 1.5mm <sup>2</sup> için	1985580000	42,05 TL	20
ZQV 1.5N/10 BL	10-pole	A serisi 1.5mm <sup>2</sup> için	1985800000	42,05 TL	20
ZQV 1.5N/10 RD	10-pole	A serisi 1.5mm <sup>2</sup> için	1985800000	42,05 TL	20
ZQV 1.5N/20	20-pole	A serisi 1.5mm <sup>2</sup> için	1985600000	80,10 TL	20
ZQV 1.5N/50	50-pole	A serisi 1.5mm <sup>2</sup> için	1985620000	219,50 TL	5
ZQV 2.5N/2	2-pole	A serisi 2.5mm <sup>2</sup> için	1527540000	5,44 TL	60
ZQV 2.5N/3	3-pole	A serisi 2.5mm <sup>2</sup> için	1527570000	9,54 TL	60
ZQV 2.5N/4	4-pole	A serisi 2.5mm <sup>2</sup> için	1527590000	14,15 TL	60
ZQV 2.5N/5	5-pole	A serisi 2.5mm <sup>2</sup> için	1527620000	18,70 TL	20
ZQV 2.5N/6	6-pole	A serisi 2.5mm <sup>2</sup> için	1527630000	23,85 TL	20
ZQV 2.5N/7	7-pole	A serisi 2.5mm <sup>2</sup> için	1527640000	28,80 TL	20
ZQV 2.5N/8	8-pole	A serisi 2.5mm <sup>2</sup> için	1527670000	33,65 TL	20
ZQV 2.5N/9	9-pole	A serisi 2.5mm <sup>2</sup> için	1527680000	38,30 TL	20
ZQV 2.5N/10	10-pole	A serisi 2.5mm <sup>2</sup> için	1527690000	42,05 TL	20
ZQV 2.5N/20	20-pole	A serisi 2.5mm <sup>2</sup> için	1527720000	80,10 TL	20
ZQV 2.5N/50	50-pole	A serisi 2.5mm <sup>2</sup> için	1527730000	219,50 TL	5
ZQV 4N/2	2-pole	A serisi 4mm <sup>2</sup> için	1527930000	5,58 TL	60
ZQV 4N/3	3-pole	A serisi 4mm <sup>2</sup> için	1527940000	10,20 TL	60
ZQV 4N/4	4-pole	A serisi 4mm <sup>2</sup> için	1527970000	15,25 TL	60
ZQV 4N/5	5-pole	A serisi 4mm <sup>2</sup> için	1527980000	20,05 TL	60
ZQV 4N/6	6-pole	A serisi 4mm <sup>2</sup> için	1527990000	24,90 TL	20
ZQV 4N/7	7-pole	A serisi 4mm <sup>2</sup> için	1528020000	29,60 TL	20
ZQV 4N/8	8-pole	w3	1528030000	34,55 TL	20
ZQV 4N/9	9-pole	A serisi 4mm <sup>2</sup> için	1528070000	39,10 TL	20
ZQV 4N/10	10-pole	A serisi 4mm <sup>2</sup> için	1528090000	44,95 TL	20
ZQV 4N/50	50-pole	A serisi 4mm <sup>2</sup> için	1528130000	256,60 TL	5
ZQV 6N/2	2-pole	A serisi 6mm <sup>2</sup> için	1985740000	6,72 TL	60
ZQV 6N/3	3-pole	A serisi 6mm <sup>2</sup> için	1985760000	13,55 TL	60
ZQV 6N/4	4-pole	A serisi 6mm <sup>2</sup> için	1985780000	20,05 TL	60
* ZQV 10N/2	2-pole	A serisi 10mm <sup>2</sup> için	2497250000	12,75 TL	25
* ZQV 16N/2	2-pole	A serisi 16mm <sup>2</sup> için	2497290000	17,30 TL	25

# PUSH - IN & Yay Bağlantılı Soketli Klemens Çözümleri

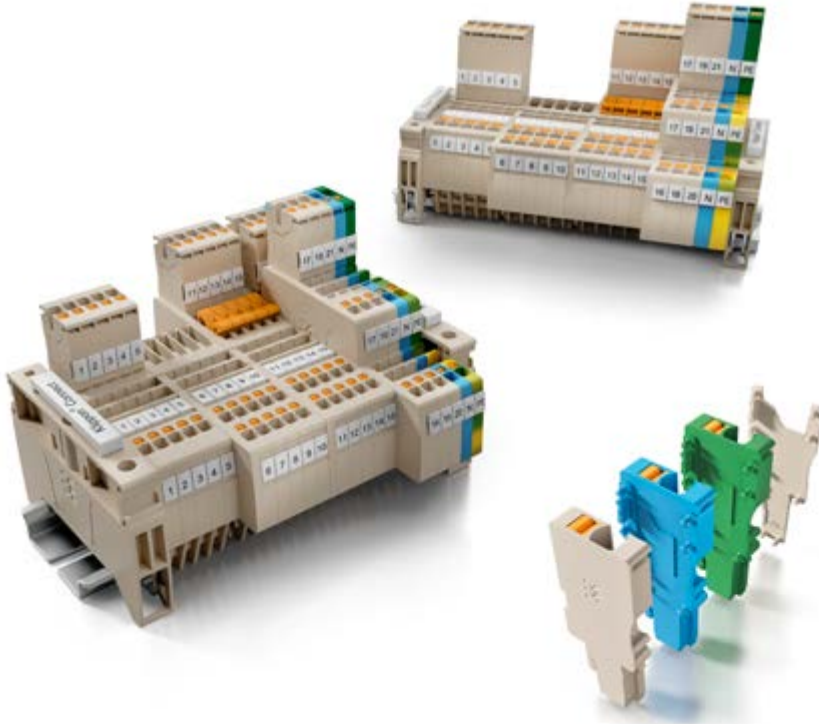

APGTB 2.5 FT 2C/1



APGTB 2.5 FT 3C/1

Tip	V / A	Kesit - mm <sup>2</sup> (Yüksüksüz)	Sipariş No	Fiyat/ Birim	Ambalaj
<b>Push-in Bağlantılı Soketli Klemensler / Geçiş Taban Modül</b>					
APGTB 1.5 FT 2C/1	500/17.5	1.5 mm <sup>2</sup>	2482160000	9,95 TL	50
APGTB 1.5 FT 2C/1 BL	500/17.5	1.5 mm <sup>2</sup>	2482170000	9,95 TL	50
APGTB 1.5 FT 3C/1	500/17.5	1.5 mm <sup>2</sup>	2482180000	12,30 TL	50
APGTB 1.5 FT 3C/1 BL	500/17.5	1.5 mm <sup>2</sup>	2482190000	12,30 TL	50
APGTB 1.5 FT 4C/2	500/17.5	1.5 mm <sup>2</sup>	2482200000	13,85 TL	50
APGTB 1.5 FT 4C/2 BL	500/17.5	1.5 mm <sup>2</sup>	2482210000	13,85 TL	50
APGTB 1.5 2T 4C/2	500/17.5	1.5 mm <sup>2</sup>	2485840000	19,25 TL	50
APGTB 1.5 2T 4C/2 BL	500/17.5	1.5 mm <sup>2</sup>	2485850000	19,25 TL	50
APGTB 1.5 2T VL 4C/2	500/17.5	1.5 mm <sup>2</sup>	2485920000	43,30 TL	50
APGTB 1.5 2T VL 4C/2 BL	500/17.5	1.5 mm <sup>2</sup>	2485930000	43,30 TL	50
APGTB 2.5 FT 2C/1	800/24	2.5 mm <sup>2</sup>	1513970000	10,75 TL	100
APGTB 2.5 FT 2C/1 BL	800/24	2.5 mm <sup>2</sup>	1513990000	10,75 TL	100
APGTB 2.5 FT 3C/1	800/24	2.5 mm <sup>2</sup>	1514000000	16,70 TL	50
APGTB 2.5 FT 3C/1 BL	800/24	2.5 mm <sup>2</sup>	1514020000	16,70 TL	50
APGTB 2.5 FT 4C/2	800/24	2.5 mm <sup>2</sup>	1514030000	22,10 TL	50
APGTB 2.5 FT 4C/2 BL	800/24	2.5 mm <sup>2</sup>	1514040000	22,10 TL	50
APGTB 2.5 2T 4C/2	800/24	2.5 mm <sup>2</sup>	1548060000	19,95 TL	50
APGTB 2.5 2T 4C/2 BL	800/24	2.5 mm <sup>2</sup>	1548070000	19,95 TL	50
APGTB 2.5 2T VL 4C/2	800/24	2.5 mm <sup>2</sup>	1548140000	53,50 TL	50
APGTB 2.5 2T VL 4C/2 BL	800/24	2.5 mm <sup>2</sup>	1548150000	53,50 TL	50
APG 2.5/3-BG-BL-GN	800/24	2.5 mm <sup>2</sup>	1513820000	33,15 TL	25



APGTB 1.5 PE 2C/1



APG 1.5 L BL



MCV APG 2.5



APG 2.5 L

Tip	V / A	Kesit - mm <sup>2</sup> (Yüksüksüz)	Sipariş No	Fiyat/ Birim	Ambalaj
<b>Push-in Bağlantılı Soketli Klemensler / Toprak Taban Modül</b>					
APGTB 1.5 PE 2C/1	500/	1.5 mm <sup>2</sup>	2482220000	34,90 TL	50
APGTB 1.5 PE 3C/1	500/	1.5 mm <sup>2</sup>	2482230000	43,35 TL	50
APGTB 1.5 PE 4C/2	500/	1.5 mm <sup>2</sup>	2482240000	46,40 TL	50
APGTB 1.5 2T FT-PE 4C/2	500/17.5	1.5 mm <sup>2</sup>	2485860000	44,35 TL	50
APGTB 1.5 2T PE 4C/2	500/	1.5 mm <sup>2</sup>	2485870000	68,50 TL	50
APGTB 2.5 PE 2C/1	800/24	2.5 mm <sup>2</sup>	1513870000	35,95 TL	50
APGTB 2.5 PE 3C/1	800	2.5 mm <sup>2</sup>	1513890000	54,15 TL	50
APGTB 2.5 PE 4C/2	800/	2.5 mm <sup>2</sup>	1513920000	56,20 TL	50
APGTB 2.5 2T FT-PE 4C/2	800/24	2.5 mm <sup>2</sup>	1548130000	47,75 TL	50
APGTB 2.5 2T PE 4C/2	800/24	2.5 mm <sup>2</sup>	1548160000	70,85 TL	50
<b>Soket Grup Aksesuarları</b>					
MCV APG 1.5	APG 1,5 Serisi		2485980000	5,51 TL	50
AEP PGTB 1.5 4C/2	PGTB 1.5 4C/2 Serisi		2482510000	6,12 TL	50
AEP PGTB 1.5 4C/2 BL	PGTB 1.5 4C/2 BL Serisi		2482520000	6,12 TL	50
APG 1.5 L	500/17.5	1.5 mm <sup>2</sup>	2482250000	12,30 TL	50
APG 1.5 L BL	500/17.5	1.5 mm <sup>2</sup>	2482260000	12,30 TL	50
APG 1.5 L GN	500/17.5zz	1.5 mm <sup>2</sup>	2482270000	12,30 TL	50
APG 1.5 MI	500/17.5	1.5 mm <sup>2</sup>	2482280000	12,30 TL	50
APG 1.5 MI BL	500/17.5	1.5 mm <sup>2</sup>	2482290000	12,30 TL	50
APG 1.5 MI GN	500/17.5	1.5 mm <sup>2</sup>	2482300000	12,30 TL	50
APG 1.5 R	500/17.5	1.5 mm <sup>2</sup>	2482310000	12,30 TL	50
APG 1.5 R BL	500/17.5	1.5 mm <sup>2</sup>	2482320000	12,30 TL	50
APG 1.5 R GN	500/17.5	1.5 mm <sup>2</sup>	2482330000	12,30 TL	50
APG 1.5/1	500/17.5	1.5 mm <sup>2</sup>	2482340000	12,30 TL	50
APG 1.5/2	500/17.5	1.5 mm <sup>2</sup>	2482350000	20,70 TL	25
APG 1.5/3	500/17.5	1.5 mm <sup>2</sup>	2482360000	29,00 TL	25
APG 1.5/3-BG-BL-GN	500/17.5	1.5 mm <sup>2</sup>	2482460000	33,15 TL	25
APG 1.5/4	500/17.5	1.5 mm <sup>2</sup>	2482370000	37,40 TL	25
APG 1.5/4-3BG-GN	500/17.5	1.5 mm <sup>2</sup>	2482450000	42,00 TL	25
APG 1.5/5	500/17.5	1.5 mm <sup>2</sup>	2482380000	45,75 TL	25
APG 1.5/5-3BG-BL-GN	500/17.5	1.5 mm <sup>2</sup>	2482440000	50,40 TL	25
APG 1.5/6	500/17.5	1.5 mm <sup>2</sup>	2482390000	54,15 TL	25
APG 1.5/7	500/17.5	1.5 mm <sup>2</sup>	2482400000	62,60 TL	25
APG 1.5/8	500/17.5	1.5 mm <sup>2</sup>	2482410000	70,85 TL	20
APG 1.5/9	500/17.5	1.5 mm <sup>2</sup>	2482420000	79,25 TL	20
APG 1.5/10	500/17.5	1.5 mm <sup>2</sup>	2482430000	87,65 TL	20
MCV APG 2.5	500/17.5	1.5 mm <sup>2</sup>	2035590000	6,32 TL	50
AEP PGTB 2.5 4C/2	500/17.5	1.5 mm <sup>2</sup>	1514450000	6,32 TL	50
AEP PGTB 2.5 4C/2 BL	500/17.5	1.5 mm <sup>2</sup>	1514470000	6,32 TL	50
APG 2.5 L	500/17.5	2.5 mm <sup>2</sup>	1513830000	13,55 TL	50
APG 2.5 L BL	500/17.5	2.5 mm <sup>2</sup>	1513840000	13,55 TL	50
APG 2.5 L GN	500/17.5	2.5 mm <sup>2</sup>	1513850000	13,55 TL	50
APG 2.5 MI	500/17.5	2.5 mm <sup>2</sup>	1513880000	13,55 TL	50
APG 2.5 MI BL	500/17.5	2.5 mm <sup>2</sup>	1513900000	13,55 TL	50
APG 2.5 MI GN	500/17.5	2.5 mm <sup>2</sup>	1513930000	13,55 TL	50
APG 2.5 R	500/17.5	2.5 mm <sup>2</sup>	1513940000	13,55 TL	50
APG 2.5 R BL	500/17.5	2.5 mm <sup>2</sup>	1513950000	13,55 TL	50
APG 2.5 R GN	500/17.5	2.5 mm <sup>2</sup>	1513980000	13,55 TL	50

Serinin devamı sayfa 26

## Soketli Klemens Çözümleri



APG 2.5/1



APG 2.5/3



ZT 2.5/2AN/1



ZTPE 2.5/2AN/1



ZTPE 2.5/4AN/2



ZDT 2.5/2



ZP 2.5/1AN/1

Tip	V / A	Kesit - mm <sup>2</sup> (Yüksüzsüz)	Sipariş No	Fiyat/ Birim	Ambalaj
APG 2.5/1	1 pin	2.5 mm <sup>2</sup>	1513720000	12,90 TL	50
APG 2.5/2	2 pin	2.5 mm <sup>2</sup>	1513640000	19,50 TL	25
APG 2.5/3	3 pin	2.5 mm <sup>2</sup>	1513650000	26,60 TL	25
APG 2.5/3-BG-BL-GN	3 pin	2.5 mm <sup>2</sup>	1513820000	33,15 TL	25
APG 2.5/4	4 pin	2.5 mm <sup>2</sup>	1513670000	38,00 TL	25
APG 2.5/4-3BG-GN	4 pin	2.5 mm <sup>2</sup>	1513790000	49,80 TL	25
APG 2.5/5	5 pin	2.5 mm <sup>2</sup>	1513680000	46,50 TL	25
APG 2.5/5-3BG-BL-GN	5 pin	2.5 mm <sup>2</sup>	1513780000	58,05 TL	25
APG 2.5/6	6 pin	2.5 mm <sup>2</sup>	1513690000	55,20 TL	25
APG 2.5/7	7 pin	2.5 mm <sup>2</sup>	1513700000	63,30 TL	25
APG 2.5/8	8 pin	2.5 mm <sup>2</sup>	1513730000	71,95 TL	20
APG 2.5/9	9 pin	2.5 mm <sup>2</sup>	1513740000	80,65 TL	20
APG 2.5/10	10 pin	2.5 mm <sup>2</sup>	1513770000	89,15 TL	20

### Yay Bağlantılı Soketli Klemensler / Geçiş Taban Modül

ZT 2.5/2AN/1	500 / 24	0.5 - 4 mm <sup>2</sup> / 1 Yay - 1 Soket Bağlantı	1815070000	14,15 TL	50
ZT 2.5/3AN/1	500 / 24	0.5 - 4 mm <sup>2</sup> / 2 Yay - 1 Soket Bağlantı	1815090000	20,10 TL	50
ZT 2.5/4AN/2	500 / 24	0.5 - 4 mm <sup>2</sup> / 2 Yay - 2 Soket Bağlantı	1815110000	23,80 TL	50
ZT 2.5/4AN/4	500 / 24	0.5 - 4 mm <sup>2</sup> / 4 Soket Bağlantı	1815130000	20,10 TL	50
ZT 4/2AN/1	800 / 32	0.5 - 6 mm <sup>2</sup> / 1 Yay - 1 Soket Bağlantı	1854960000	21,15 TL	50
ZT 4/4AN/2	800 / 32	0.5 - 6 mm <sup>2</sup> / 2 Yay - 2 Soket Bağlantı	1848350000	34,55 TL	50

### Yay Bağlantılı Soketli Klemensler / Toprak Taban Modül

ZTPE 2.5/2AN/1	500	0.5 - 4 mm <sup>2</sup> / 1 Yay - 1 Soket Bağlantı	1815080000	26,20 TL	50
ZTPE 2.5/3AN/1	500	0.5 - 4 mm <sup>2</sup> / 2 Yay - 1 Soket Bağlantı	1815100000	34,55 TL	50
ZTPE 2.5/4AN/2	500	0.5 - 4 mm <sup>2</sup> / 2 Yay - 2 Soket Bağlantı	1815120000	36,60 TL	50
ZTPE 2.5/4AN/4	500	0.5 - 4 mm <sup>2</sup> / 4 Soket Bağlantı	1815140000	34,55 TL	50
ZTPE 4/2AN/1	800	0.5 - 6 mm <sup>2</sup> / 1 Yay - 1 Soket Bağlantı	1854970000	36,60 TL	50
ZTPE 4/4AN/2	800	0.5 - 6 mm <sup>2</sup> / 2 Yay - 2 Soket Bağlantı	1848330000	59,75 TL	50

### Yay Bağlantılı Soketli Klemensler / İki Katlı ve Ayrırma Taban Modül

ZDT 2.5/2	500 / 24	0.5 - 4 mm <sup>2</sup> / Her Kat 1 Yay - 1 Soket Bağlantı	1815150000	34,55 TL	50
ZDT 2.5/2 DU-PE	500 / 24	0.5 - 4 mm <sup>2</sup> / Her Kat 1 Yay - 1 Soket Bağlantı / Alt Toprak	1815160000	52,55 TL	50
ZTTR 2.5	400 / 16	0.5 - 4 mm <sup>2</sup> / 2 Yay - 1 Soket Bağlantı / Ayrırma	1865510000	33,05 TL	50
ZTTR 2.5.0TNE	400 / 16	0.5 - 4 mm <sup>2</sup> / 2 Yay - 1 Soket Bağlantı / SIHA - BEST	1905470000	30,95 TL	50

### Yay Bağlantılı Soketli Klemensler / Soketler

ZP 2.5/1AN/1	500 / 24	0.5 - 4 mm <sup>2</sup> / 1 Kutup	1815430000	16,05 TL	50
ZP 2.5/1AN/2	500 / 24	0.5 - 4 mm <sup>2</sup> / 2 Kutup	1815440000	28,10 TL	25
ZP 2.5/1AN/3	500 / 24	0.5 - 4 mm <sup>2</sup> / 3 Kutup	1815450000	40,95 TL	25
ZP 2.5/1AN/4	500 / 24	0.5 - 4 mm <sup>2</sup> / 4 Kutup	1815500000	52,55 TL	25
ZP 2.5/1AN/5	500 / 24	0.5 - 4 mm <sup>2</sup> / 5 Kutup	1815510000	54,05 TL	25
ZP 2.5/1AN/6	500 / 24	0.5 - 4 mm <sup>2</sup> / 6 Kutup	1815520000	59,00 TL	25
ZP 2.5/1AN/7	500 / 24	0.5 - 4 mm <sup>2</sup> / 7 Kutup	1815530000	68,25 TL	25
ZP 2.5/1AN/8	500 / 24	0.5 - 4 mm <sup>2</sup> / 8 Kutup	1815540000	76,95 TL	20
ZP 2.5/1AN/9	500 / 24	0.5 - 4 mm <sup>2</sup> / 9 Kutup	1815550000	86,40 TL	20
ZP 2.5/1AN/10	500 / 24	0.5 - 4 mm <sup>2</sup> / 10 Kutup	1815560000	121,60 TL	20
ZP 2.5/1AN/11	500 / 24	0.5 - 4 mm <sup>2</sup> / 11 Kutup	1815570000	124,45 TL	20
ZP 2.5/1AN/12	500 / 24	0.5 - 4 mm <sup>2</sup> / 12 Kutup	1815580000	125,20 TL	20
ZP 2.5/1AN/13	500 / 24	0.5 - 4 mm <sup>2</sup> / 13 Kutup	1815590000	126,60 TL	10
ZP 2.5/1AN/14	500 / 24	0.5 - 4 mm <sup>2</sup> / 14 Kutup	1815600000	133,05 TL	10
ZP 2.5/1AN/15	500 / 24	0.5 - 4 mm <sup>2</sup> / 15 Kutup	1815610000	142,45 TL	10

Serinin devamı sayfa 27



ZP 2.5/1AN/16



ZP 4/1AN/3



ZAP/TW ZT2.5/2AN

Tip	V / A	Kesit - mm <sup>2</sup> (Yüksüksüz)	Sipariş No	Fiyat/ Birim	Ambalaj
ZP 2.5/1AN/16	500 / 24	0.5 - 4 mm <sup>2</sup> / 16 Kutup	1815620000	151,80 TL	10
ZP 2.5/1AN/17	500 / 24	0.5 - 4 mm <sup>2</sup> / 17 Kutup	1815180000	163,95 TL	10
ZP 2.5/1AN/QV/1	500 / 24	0.5 - 4 mm <sup>2</sup> / 1 Kutup / Köprülenebilir	1815190000	17,20 TL	50
ZP 2.5/1AN/QV/2	500 / 24	0.5 - 4 mm <sup>2</sup> / 2 Kutup / Köprülenebilir	1815200000	30,95 TL	25
ZP 2.5/1AN/QV/3	500 / 24	0.5 - 4 mm <sup>2</sup> / 3 Kutup / Köprülenebilir	1815210000	40,95 TL	25
ZP 2.5/1AN/QV/4	500 / 24	0.5 - 4 mm <sup>2</sup> / 4 Kutup / Köprülenebilir	1815220000	54,65 TL	25
ZP 2.5/1AN/QV/10	500 / 24	0.5 - 4 mm <sup>2</sup> / 10 Kutup / Köprülenebilir	1815280000	121,60 TL	20
ZP 4/1AN/1	800 / 32	0.5 - 6 mm <sup>2</sup> / 1 Kutup	1848340000	28,50 TL	50
ZP 4/1AN/2	800 / 32	0.5 - 6 mm <sup>2</sup> / 2 Kutup	1854990000	48,15 TL	25
ZP 4/1AN/3	800 / 32	0.5 - 6 mm <sup>2</sup> / 3 Kutup	1855000000	63,95 TL	25
ZP 4/1AN/4	800 / 32	0.5 - 6 mm <sup>2</sup> / 4 Kutup	1855010000	83,40 TL	25
ZP 4/1AN/10	800 / 32	0.5 - 6 mm <sup>2</sup> / 10 Kutup	1855070000	213,65 TL	10

Tip	Açıklama	Sipariş No	Fiyat/Birim	Ambalaj
<b>Yaylı Bağlantı Nihayet Plakaları</b>				
ZAP/TW ZT2.5/2AN	ZT 2.5/2AN Serisi	1816030000	4,91 TL	50
ZAP/TW ZT2.5/3AN	ZT 2.5/3AN Serisi	1816050000	4,91 TL	50
ZAP/TW ZT2.5/4AN/2	ZT 2.5/4AN/2 Serisi	1816070000	6,45 TL	50
ZAP/TW ZT2.5/4AN/4	ZT 2.5/4AN/4 Serisi	1816090000	6,45 TL	50

## Güç ve Sinyal Dağıtım Çözümleri



AAP Serisi PUSH-IN Dağıtım Blokları



Marshalling, Güç Dağıtım Klemensleri



WPD Güç Dağıtım Klemensi

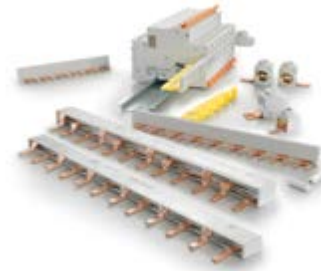

Güç Dağıtım Baraları



SET AAP11 6/1.5/12C



AAP11 6/6X1.5 LO-LI BL



AAP11 6 LO RD



AAP11 6 LO OR

Tip	Açıklama	Çıkış	Sipariş No	Fiyat/Birim	Ambalaj
-----	----------	-------	------------	-------------	---------

## AAP Serisi PUSH-IN Dağıtım Blokları

## Faz Nötr Ayrı Hazır Bloklar

SET AAP11 6/1.5/12C	Faz ve Nötr Girişleri 6 mm <sup>2</sup>	12xFaz ve 12xNötr (1.5mm <sup>2</sup> )	2506090000	212,80 TL	1
SET AAP11 6/1.5/24C	Faz ve Nötr Girişleri 6 mm <sup>2</sup>	24xFaz ve 24xNötr (1.5mm <sup>2</sup> )	2506370000	336,00 TL	1
SET AAP12 10/2.5/10C	Faz ve Nötr Girişleri 10 mm <sup>2</sup>	10xFaz ve 10xNötr (2.5mm <sup>2</sup> )	2506350000	291,20 TL	1

\*Farklı konfigürasyonlar için ürünler tek tek kombinlenebilir.

## Faz Nötr Aynı Sırada Hazır Bloklar

SET AAP13 6/1.5/12C	Faz ve Nötr Girişleri 6 mm <sup>2</sup>	12xFaz ve 12xNötr (1.5mm <sup>2</sup> )	2506340000	217,35 TL	1
SET AAP13 6/1.5/24C	Faz ve Nötr Girişleri 6 mm <sup>2</sup>	24xFaz ve 24xNötr (1.5mm <sup>2</sup> )	2506380000	382,00 TL	1
SET AAP14 10/2.5/10C	Faz ve Nötr Girişleri 10 mm <sup>2</sup>	10xFaz ve 10xNötr (2.5mm <sup>2</sup> )	2506360000	268,80 TL	1

\*Farklı konfigürasyonlar için ürünler tek tek kombinlenebilir.

6x1.5 mm<sup>2</sup> Yan kapaksız Hazır Bloklar

AAP11 6/6X1.5 LO-LI BL	6 mm <sup>2</sup> Girişli Bej (Kırmızı Butonlu)	6x1.5 mm <sup>2</sup>	2464750000	56,00 TL	20
AAP11 6/6X1.5 LO-LI RD	6 mm <sup>2</sup> Girişli Bej (Mavi Butonlu)	6x1.5 mm <sup>2</sup>	2464690000	56,00 TL	20
AAP11 6/6X1.5 PE-LI	Sarı-Yeşil 6 mm <sup>2</sup> (Topraklama)	6x1.5 mm <sup>2</sup>	2464740000	72,80 TL	20
AAP11 6/6X1.5 LO-LI BL/OR	Mavi 6 mm <sup>2</sup> Girişli	6x1.5 mm <sup>2</sup>	2522830000	61,60 TL	20

\*Yan kapak olarak 1988320000 kullanılacaktır.

Tip	V / A	Kesit - mm <sup>2</sup> (Yüksüksüz)	Sipariş No	Fiyat/Birim	Ambalaj
-----	-------	-------------------------------------	------------	-------------	---------

## AAP Serisi PUSH-IN Dağıtım Blokları

## Potansiyel Dağıtım Blokları için Besleme Modülleri

AAP11 6 LO RD	500/41	6 mm <sup>2</sup>	1989780000	27,55 TL	20
AAP11 6 LO BL/OR	500/41	6 mm <sup>2</sup>	2522720000	29,00 TL	20
AAP11 6 LO BL	500/41	6 mm <sup>2</sup>	1988130000	27,55 TL	20
AAP11 6 LO OR	500/41	6 mm <sup>2</sup>	2503650000	29,00 TL	20

Serinin devamı sayfa 29

Tip	V / A	Kesit - mm <sup>2</sup> (Yüksüksüz)	Sipariş No	Fiyat/Birim	Ambalaj
AAP13 6 LO-LO	250/41	6 mm <sup>2</sup>	1988260000	48,20 TL	20
AAP12 10 LO RD	800/57	10 mm <sup>2</sup>	1988190000	62,05 TL	20
AAP12 10 LO BL	800/57	10 mm <sup>2</sup>	1988180000	62,05 TL	20
AAP12 10 LO BL/OR	800/57	10 mm <sup>2</sup>	2522860000	65,30 TL	20
AAP12 10 LO OR	800/57	10 mm <sup>2</sup>	2503900000	65,30 TL	20
AAP14 10 LO-LO	500/57	10 mm <sup>2</sup>	1988250000	82,70 TL	20

\*Farklı renklerdeki seçimler için lütfen bizimle iletişime geçebilirsiniz.

#### Potansiyel Dağıtım Klemensleri

AAP11 1.5 LI RD	500/17.5	1.5 mm <sup>2</sup>	1988160000	30,30 TL	50
AAP11 1.5 LI BL	500/17.5	1.5 mm <sup>2</sup>	1988170000	30,30 TL	50
AAP11 1.5 LI BL/OR	500/17.5	1.5 mm <sup>2</sup>	2522870000	31,90 TL	50
AAP11 1.5 LI OR	500/17.5	1.5 mm <sup>2</sup>	2503910000	31,90 TL	50
AAP13 1.5 LI-LI	250/17.5	1.5 mm <sup>2</sup>	1988280000	34,50 TL	50
AAP12 2.5 LI RD	800/24	2.5 mm <sup>2</sup>	1988290000	34,50 TL	50
AAP12 2.5 LI BL	800/24	2.5 mm <sup>2</sup>	1988100000	34,50 TL	50
AAP12 2.5 LI BL/OR	800/24	2.5 mm <sup>2</sup>	2522840000	36,30 TL	50
AAP12 2.5 LI OR	800/24	2.5 mm <sup>2</sup>	2503880000	36,30 TL	50
AAP14 2.5 LI-LI	500/24	2.5 mm <sup>2</sup>	1988230000	34,50 TL	50

\*Farklı renklerdeki seçimler için lütfen bizimle iletişime geçebilirsiniz.

#### Potansiyel Dağıtım Klemensleri Sonlandırma Plakaları

AEP AP11	APP11		1988320000	7,93 TL	20
AEP AP12	APP12		1988300000	7,93 TL	20
AEP AP13	APP13		1990140000	9,54 TL	20
AEP AP14	APP14		1988340000	9,54 TL	20

#### Sensör Bağlantı Klemensleri

AIO21 1.5 SI	250/13.5	1.5 mm <sup>2</sup>	1992260000	33,05 TL	100
AIO21 1.5 SO	250/13.5	1.5 mm <sup>2</sup>	1992240000	30,85 TL	100
AIO21 1.5 SO-PE	250/13.5	1.5 mm <sup>2</sup>	1992250000	56,05 TL	100
AIO22 1.5 SI-PE	250/13.5	1.5 mm <sup>2</sup>	1992230000	59,20 TL	100
AIO23 1.5 2SI	250/13.5	1.5 mm <sup>2</sup>	1992220000	62,95 TL	100

#### Sensör Bağlantı Klemensleri Yan Kapakları

AEP IO21	AIO21		1993580000	7,93 TL	50
AEP IO22	AIO22		1993590000	7,93 TL	50
AEP IO23	AIO23		1993600000	9,54 TL	50

#### Marshalling, Güç Dağıtım Klemensleri ve Aksesuarları

##### Marshalling Geçiş Klemensleri

PRV 4 SW 35X15 RT	250 / 10	0.2 - 1.5 mm <sup>2</sup> / TS35x15 / Dört Kat / 16 Bağlantı	1173810000	123,05 TL	20
PRV 4 BL 35X15 RT	250 / 10	0.2 - 1.5 mm <sup>2</sup> / TS35x15 / Dört Kat / 16 Bağlantı	1267890000	123,05 TL	20
PRV 4 SW 35X7.5 RT	250 / 10	0.2 - 1.5 mm <sup>2</sup> / TS35x7.5 / Dört Kat / 16 Bağlantı	1173830000	123,05 TL	20
PRV 4 BL 35X7.5 RT	250 / 10	0.2 - 1.5 mm <sup>2</sup> / TS35x7.5 / Dört Kat / 16 Bağlantı	1267900000	123,05 TL	20
PRV 4 SW 35X15 WS	250 / 10	0.2 - 1.5 mm <sup>2</sup> / TS35x15 / Dört Kat / 16 Bağlantı	1173820000	123,05 TL	20
PRV 4 BL 35X15 WS	250 / 10	0.2 - 1.5 mm <sup>2</sup> / TS35x15 / Dört Kat / 16 Bağlantı	1173920000	123,05 TL	20
PRV 4 SW 35X7.5 WS	250 / 10	0.2 - 1.5 mm <sup>2</sup> / TS35x7.5 / Dört Kat / 16 Bağlantı	1173840000	123,05 TL	20
PRV 4 BL 35X7.5 WS	250 / 10	0.2 - 1.5 mm <sup>2</sup> / TS35x7.5 / Dört Kat / 16 Bağlantı	1173930000	123,05 TL	20
PRV 8 SW 35X15 RT/WS	250 / 8	0.2 - 1.5 mm <sup>2</sup> / TS35x15 / Sekiz Kat / 32 Bağlantı	1173740000	237,35 TL	20
PRV 8 BL 35X15 RT/WS	250 / 8	0.2 - 1.5 mm <sup>2</sup> / TS35x15 / Sekiz Kat / 32 Bağlantı	1267830000	237,35 TL	20
PRV 8 SW 35X7.5 RT/WS	250 / 8	0.2 - 1.5 mm <sup>2</sup> / TS35x7.5 / Sekiz Kat / 32 Bağlantı	1173790000	237,35 TL	20
PRV 8 BL 35X7.5 RT/WS	250 / 8	0.2 - 1.5 mm <sup>2</sup> / TS35x7.5 / Sekiz Kat / 32 Bağlantı	1267840000	237,35 TL	20
PRV 8 SW 35X15 WS/RT	250 / 8	0.2 - 1.5 mm <sup>2</sup> / TS35x15 / Sekiz Kat / 32 Bağlantı	1173780000	237,35 TL	20



AAP11 1.5 LI RD



AEP AP11



AIO21 1.5 SI



AEP IO21



PRV 4 SW 35X15 RT



PRV 8 SW 35X15 RT/WS

Serinin devamı sayfa 30





PRV 16 SW 35X15 RT/WS



PPV 4 BL 35X15 DGR



PAP PRV/PPV4 SW



TW PRV4 1-4

Tip	V / A	Kesit - mm <sup>2</sup> (Yüksüksüz)	Sipariş No	Fiyat/Birim	Ambalaj
PRV 8 BL 35X15 WS/RT	250 / 8	0.2 - 1.5 mm <sup>2</sup> / TS35x15 / Sekiz Kat / 32 Bağlantı	1173900000	237,35 TL	20
PRV 8 SW 35X7.5 WS/RT	250 / 8	0.2 - 1.5 mm <sup>2</sup> / TS35x7.5 / Sekiz Kat / 32 Bağlantı	1173800000	237,35 TL	20
PRV 8 BL 35X7.5 WS/RT	250 / 8	0.2 - 1.5 mm <sup>2</sup> / TS35x7.5 / Sekiz Kat / 32 Bağlantı	1173910000	237,35 TL	20
PRV 16 SW 35X15 RT/WS	250 / 6	0.2 - 1.5 mm <sup>2</sup> / TS35x15 / Onaltı Kat / 64 Bağlantı	1173620000	518,00 TL	20
PRV 16 BL 35X15 RT/WS	250 / 6	0.2 - 1.5 mm <sup>2</sup> / TS35x15 / Onaltı Kat / 64 Bağlantı	1267790000	518,00 TL	20
PRV 16 SW 35X7.5 RT/WS	250 / 6	0.2 - 1.5 mm <sup>2</sup> / TS35x7.5 / Onaltı Kat / 64 Bağlantı	1173680000	518,00 TL	20
PRV 16 BL 35X7.5 RT/WS	250 / 6	0.2 - 1.5 mm <sup>2</sup> / TS35x7.5 / Onaltı Kat / 64 Bağlantı	1267810000	518,00 TL	20
PRV 16 SW 35X15 WS/RT	250 / 6	0.2 - 1.5 mm <sup>2</sup> / TS35x15 / Onaltı Kat / 64 Bağlantı	1173650000	518,00 TL	20
PRV 16 BL 35X15 WS/RT	250 / 6	0.2 - 1.5 mm <sup>2</sup> / TS35x15 / Onaltı Kat / 64 Bağlantı	1267800000	518,00 TL	20
PRV 16 SW 35X7.5 WS/RT	250 / 6	0.2 - 1.5 mm <sup>2</sup> / TS35x7.5 / Onaltı Kat / 64 Bağlantı	1173710000	518,00 TL	20
PRV 16 BL 35X7.5 WS/RT	250 / 6	0.2 - 1.5 mm <sup>2</sup> / TS35x7.5 / Onaltı Kat / 64 Bağlantı	1267820000	518,00 TL	20

#### Güç Dağıtım Klemensleri - Eş Potansiyel Bara Tip

PPV 4 BL 35X15 DGR	250 / 17.5	0.2 - 1.5 mm <sup>2</sup> / TS35x15 / Dört Kat / 16 Bağlantı	1267910000	131,70 TL	20
PPV 4 GR 35X15 DGR	250 / 17.5	0.2 - 1.5 mm <sup>2</sup> / TS35x15 / Dört Kat / 16 Bağlantı	1173880000	131,70 TL	20
PPV 4 BL 35X7.5 DGR	250 / 17.5	0.2 - 1.5 mm <sup>2</sup> / TS35x7.5 / Dört Kat / 16 Bağlantı	1267920000	131,70 TL	20
PPV 4 GR 35X7.5 DGR	250 / 17.5	0.2 - 1.5 mm <sup>2</sup> / TS35x7.5 / Dört Kat / 16 Bağlantı	1173890000	131,70 TL	20
PPV 8 BL 35X15 DGR	250 / 17.5	0.2 - 1.5 mm <sup>2</sup> / TS35x15 / Sekiz Kat / 32 Bağlantı	1267870000	254,70 TL	20
PPV 8 GR 35X15 DGR	250 / 17.5	0.2 - 1.5 mm <sup>2</sup> / TS35x15 / Sekiz Kat / 32 Bağlantı	1173850000	254,70 TL	20
PPV 8 BL 35X7.5 DGR	250 / 17.5	0.2 - 1.5 mm <sup>2</sup> / TS35x7.5 / Sekiz Kat / 32 Bağlantı	1267880000	254,70 TL	20
PPV 8 GR 35X7.5 DGR	250 / 17.5	0.2 - 1.5 mm <sup>2</sup> / TS35x7.5 / Sekiz Kat / 32 Bağlantı	1173870000	254,70 TL	20

Tip	Açıklama	Sipariş No	Fiyat/Birim	Ambalaj
<b>Marshalling, Güç Dağıtım Klemensleri ve Aksesuarları</b>				
<b>Nihayet Plakaları</b>				
PAP PRV/PPV4 SW	PRV4 ve PPV4 Serisi - Siyah	1173750000	7,26 TL	10
PAP PRV/PPV4 GR	PRV4 ve PPV4 Serisi - Gri	1211450000	7,26 TL	10
PAP PRV/PPV8 SW	PRV8 ve PPV8 Serisi - Siyah	1173720000	11,00 TL	10
PAP PRV/PPV8 GR	PRV8 ve PPV8 Serisi - Siyah	1211460000	11,00 TL	10
<b>Ayırma Plakaları</b>				
TW PRV4	Baskısız	1173700000	9,00 TL	10
TW PRV4 0-3	0...3 Baskı	1230060000	22,55 TL	10
TW PRV4 1-4	1...4 Baskı	1230050000	22,55 TL	10
TW PRV4 A-D	A...D Baskı	1230070000	22,55 TL	10
TW PRV8	Baskısız	1173670000	14,45 TL	10
TW PRV8 0-7	0...7 Baskı	1230090000	23,05 TL	10
TW PRV8 1-8	1...8 Baskı	1230080000	23,05 TL	10
TW PRV8 A-H	A...H Baskı	1230110000	23,05 TL	10
TW PRV16	Baskısız	1173630000	35,75 TL	10
TW PRV16 0-15	0...15 Baskı	1230130000	44,65 TL	10
TW PRV16 1-16	1...16 Baskı	1230120000	44,65 TL	10
TW PRV16 A-P	A...P Baskı	1230140000	44,65 TL	10

Tip	V/A	Kesit mm <sup>2</sup>	Sipariş No	Fiyat/Birim	Ambalaj
<b>WPD Güç Dağıtım Klemensi</b>					
WPD 130 1X50/1X50 GY	1000 / 120	50	2502530000	95,75 TL	9
WPD 130 1X50/1X50 BL	1000 / 120	50	2502540000	95,75 TL	9
WPD 230 2X50/2X50 GY	1000 / 120	50	2502580000	176,85 TL	5
WPD 230 2X50/2X50 BL	1000 / 120	50	2502590000	176,85 TL	5
WPD 330 3X50/3X50 3XGY	1000 / 120	50	2502620000	274,30 TL	3
WPD 131 1X95/1X95 GY	1000 / 155	95	2503090000	181,70 TL	2
WPD 131 1X95/1X95 BL	1000 / 155	95	2502660000	181,70 TL	2
WPD 231 2X95/2X95 GY	1000 / 155	95	2502700000	355,55 TL	1
WPD 231 2X95/2X95 BL	1000 / 155	95	2502710000	355,55 TL	1
WPD 132 1X185/1X185 GY	1000 / 250	185	2502750000	371,85 TL	1
WPD 132 1X185/1X185 BL	1000 / 250	185	2502760000	371,85 TL	1
WPD 232 2X185/2X185 GY	1000 / 250	185	2502800000	730,00 TL	1
WPD 232 2X185/2X185 BL	1000 / 250	185	2502810000	730,00 TL	1
WPD 133 1X300/1X300 GY	1000 / 340	340 A	2502850000	907,00 TL	1
WPD 133 1X300/1X300 BL	1000 / 340	300	2502860000	907,00 TL	1
WPD 233 2X300/2X300 GY	1000 / 340	340 A	2502900000	1.801,00 TL	1
WPD 233 2X300/2X300 BL	1000 / 340	340 A	2502910000	1.801,00 TL	1

Tip	V/A	Kesit mm <sup>2</sup>	Sipariş No	Fiyat/Birim	Ambalaj
<b>WPD Potansiyel Dağıtım Blokları</b>					
* WPD 101 2X25/2X16 GY	1000 / 152	25	1560730000	120,90 TL	5
* WPD 101 2X25/2X16 BL	1000 / 152	25	1560670000	120,90 TL	5
* WPD 301 2X25/2X16 3XGY	1000 / 152	25	1561130000	354,40 TL	2
* WPD 401 2X25/2X16 3XGY/1XBL	1000 / 152	25	1562130000	466,10 TL	1
* WPD 501 2X25/2X16 1XGN/3XGY/1XBL	1000 / 152	25	1562140000	578,00 TL	1
* WPD 102 2X35/2X25 GY	1000 / 202	35	1561680000	265,50 TL	5
* WPD 102 2X35/2X25 BL	1000 / 202	35	1561640000	265,50 TL	5
* WPD 302 2X35/2X25 3XGY	1000 / 202	35	1561740000	623,00 TL	2
* WPD 103 2X70/2X50 GY	1000 / 300	70	1561770000	376,75 TL	3
* WPD 103 2X70/2X50 BL	1000 / 300	70	1561780000	376,75 TL	3
WPD 104 1x25+1x16/2x16+3x10 BL	1000 / 101	25	2518250000	331,40 TL	1
WPD 104 1x25+1x16/2x16+3x10 GY	1000 / 101	25	1562000000	331,40 TL	1
WPD 204 2X25/4X16+6X10 2XBL	1000 / 101	25	2518330000	615,00 TL	1
WPD 204 2X25/4X16+6X10 2XGY	1000 / 101	25	1562150000	615,00 TL	1
WPD 304 3X25/6X16+9X10 3XBL	1000 / 101	25	2518340000	1.180,00 TL	1
WPD 304 3X25/6X16+9X10 3XGY	1000 / 101	25	1562160000	1.180,00 TL	1
WPD 105 1x35+1x16/2x25+3x16 BL	1000 / 125	35	2518540000	549,00 TL	1
WPD 105 1x35+1x16/2x25+3x16 GY	1000 / 125	35	1562170000	549,00 TL	1
WPD 205 2X35/4X25+6X16 2XBL	1000 / 125	35	2519470000	1.081,00 TL	1
WPD 205 2X35/4X25+6X16 2XGY	1000 / 125	35	1562180000	1.081,00 TL	1
WPD 305 3X35/6X25+9X16 3XGY	1000 / 125	35	1562190000	1.557,00 TL	1
WPD 106 1X70/2X25+3X16 BL	1000 / 191	70	2518570000	664,00 TL	1
WPD 106 1X70/2X25+3X16 GY	1000 / 191	70	1562210000	664,00 TL	1
WPD 107 1X95/2X35+8X25 BL	1000 / 232	95	2521730000	831,00 TL	1
WPD 107 1X95/2X35+8X25 GY	1000 / 232	95	1562220000	831,00 TL	1
WPD 108 1X120/2X35+3X25+4X16 BL	1500 / 250	120	2519480000	1.075,00 TL	1
WPD 108 1X120/2X35+3X25+4X16 GY	1500 / 250	120	1562100000	1.075,00 TL	1
WPD 109 1X185/2X35+3X25+4X16 BL	1500 / 353	185	2519490000	1.100,00 TL	1
WPD 109 1X185/2X35+3X25+4X16 GY	1500 / 353	185	1562090000	1.100,00 TL	1

Tip	Kutup Sayısı	Modül Sayısı	Sipariş No	Fiyat/Birim	Ambalaj
<b>Otomatik Sigorta Besleme Barası (10mm<sup>2</sup> - 63A)</b>					
* S-1L-106/10	1P	6	2657930000	16,00 TL	10
* S-1L-210/10	1P	12	2657970000	20,55 TL	10

Serinin devamı sayfa 32



WPD 230 2X50/2X50 BL



WPD 101 2X25/2X16 GY

WPD 401 2X25/2X16  
3XGY/1XBL

WPD 103 2X70/2X50 BL

WPD 109  
1X185/2X35+3X25+4X16 GY

S-1L-106/10



S-1L-1000/10



S-2L-106/10



S-4L-1000/10



FIT 25 GN



FP Box



PTS 4

Tip	Kutup Sayısı	Modül Sayısı	Sipariş No	Fiyat/Birim	Ambalaj
* S-1L-320/10	1P	18	2658010000	26,60 TL	10
* S-1L-1000/10	1P	57	2658030000	32,00 TL	10
* S-2L-106/10	2P	6	2658210000	39,25 TL	5
* S-2L-210/10	2P	12	2658230000	61,00 TL	5
* S-2L-1000/10	2P	56	2658270000	45,00 TL	5
* S-3L-106/10	3P	6	2658510000	53,45 TL	5
* S-3L-210/10	3P	12	2658550000	71,90 TL	5
* S-3L-1000/10	3P	57	2658630000	86,40 TL	5
* S-4L-160/10	4P	8	2658830000	110,00 TL	5
* S-4L-210/10	4P	12	2658850000	86,10 TL	5
* S-4L-1000/10	4P	56	2658890000	110,25 TL	5

Tip	Açıklama	Sipariş No	Fiyat/Birim	Ambalaj
<b>Bara Aksesuarları</b>				
END CAP G+S 1L/10-16	1 kutup bara sonlandırma aparatı	2658970000	3,70 TL	50
END CAP G+S 2L/16	2 kutup bara sonlandırma aparatı	2658990000	4,48 TL	10
END CAP G+S 3L/16	3 kutup bara sonlandırma aparatı	2659600000	4,48 TL	10
END CAP G+S 4L/16	4 kutup bara sonlandırma aparatı	2659030000	5,94 TL	10
PROTECTION COVER G+S /5	Uyarı markalaması	2659040000	24,10 TL	10
FIT 25 GN	Motor koruma uzatma aparatı	2659050000	36,95 TL	10
FIT 25 SN	Otomatik Sigorta uzatma aparatı	2659060000	36,95 TL	10

**Not:** Baralarımızda, bara sonlandırma aparatı kullanımı zorunludur.

### FieldPower Güç Dağıtım Çözümleri

#### FieldPower Güç Dağıtım Klemensi

FP Box	IP65 5 Kutup	1957580000	70,00 €	1
FP Box 10P	IP65 10 Kutup	1957590000	130,00 €	1
PowerTerminal LG	IP30 5 Kutup Bağlantı Modülü	1963570000	50,15 €	1
PT6	IP20 5 Kutup Bağlantı Modülü	1957620000	45,00 €	1
FP Box FUSE	IP65 Sinyal Modülü	1961780000	153,00 €	1
FP Box ON/OFF	IP65 Bakım (A) Anahtarı	1003260000	245,00 €	1

#### FieldPower Asansör Uygulamaları

FP ESWB LANDING SET	230V / 6A	2483990000	189,60 TL	1
FP ESWB TERMINAL SET	230V / 6A	2524850000	193,15 TL	1

#### FieldPower Güç Dağıtım Klemensi Aksesuarlar

PTS 4	Push-In Bağlantılı Konnektör	1952120000	12,95 €	10
PTDS 4	Her Kutup için İki Bağ. Konnektör	1952130000	14,35 €	10
RKDG D9 PT6	Yuvarlak Kablo Tutucu	4329610000	3,35 €	10
RKDG D11 PT6	Yuvarlak Kablo Tutucu	4323210000	4,00 €	10
RKDG D13 PT6	Yuvarlak Kablo Tutucu	4323230000	4,00 €	10
RKDG D15 PT6	Yuvarlak Kablo Tutucu	4323220000	3,50 €	10
DG D0 PT6	Yassı Kablo Tutucu	4323240000	3,35 €	10

## Markalama Sistemleri

### Dekafix Klemens Markalama

Çeşitli konnektörler için her türlü markalama isteklerini pratik, hızlı, düzenli ve mükemmel bir görsellikte çözer. Dekafix - kullanıma hazır olan markalama her türlü klemens ve elektronik ekipmana uygundur.

### Grup Etiketleri

Grup etiket taşıyıcıları direkt ray üzerine tutturulabildikleri gibi, klemens üzerinde kullanılabilen çeşitleri de mevcuttur. SCHAT 5 ve SCHAT 5S doğrudan DIN ray üzerine tutturulur. Etiketler şeffaf bir koruyucu ile dış etkenlerden izole edilir.

### Kablo Etiketleri SlimFix ve SlimFix Clip

SlimFix (SF) kablo etiketleri kablo montajı yapıldıktan sonra takılabilir. Halogenfree malzemeden üretilmiş olup V0/V2 yanmazlık normuna uygun olarak tasarlanmıştır. SF Tool yardımı ile hızlı ve kolayca monte edilebilir. Weidmüller, çok çeşitli markalama imkanları ve baskı teknolojilerini kullanımınıza sunar.

### PrintJet Connect

Mürekkep püskürtme teknolojisini kullanarak mükemmel baskı işleri çıkaran PJ Connect yazıcı ile hem dayanıklı markalama etiketleri yazdırılabilir hem de hızlı markalama özelliği sayesinde zaman tasarrufu sağlanır. Ayrıca PJ Connect Metal markalama etiketleri üzerine baskı yapabildiği gibi algılanabilir markalama etiketlerinde de başarılı işler çıkarır. Yüksek Kapasiteli multicard haznesi sayesinde daha fazla markalama etiketi yazdırmamızı sağlar.

### Mürekkep püskürtme baskı teknolojisi

- Kolay kullanım imkanı
- Tüm Multicard ve Metal Markalama etiketlerine baskı yapabilme özelliği
- Markalama etiketi üzerine logo ve kişisel tasarım baskısı yapabilme
- Kablosuz bağlantı özelliği
- First in First out mantığı ile çalışan sıralı markalama özelliği
- Windows ile uyumlu çalışan M-Print pro yazılımı sayesinde hızlı bağlanabilme

### Hazır Baskılı Kablo Etiketleri CableLine ®

Hazır baskılı kablo etiketler CableLine ® ile 0.5 mm<sup>2</sup> ile 70mm<sup>2</sup> arası iletkenler kolay bir şekilde markalanabilir. Kapalı tip ve açık tipleri de mevcuttur. Kablo bağı ile bağlanan renkli versiyonları ayrıca üretilmektedir.

### WKM Kablo Markalama

Büyük kesitte kablolar için kablo bağı ile iletkene tutturulan bu tip, ağır sanayi şartlarına uygundur.

- 3 farklı boyut için
- Baskılı etiketler için şeffaf kapak ile koruma
- Tüm kesitler için kablo bağı ile montaj





DEK 5 FW 1-50



DEK 6 FW 1-50



DEK 8 FWZ 1-10

Tip	Baskı	Ölçü	Sipariş No	Fiyat/Birim	Ambalaj
<b>Dekafix</b>					
<b>DEK 5</b>					
DEK 5 FW 1-50	Baskı 1 - 50	5,0 mm	0473460001	0,728 TL	500
DEK 5 FW 51-100	Baskı 51 - 100	5,0 mm	0473460051	0,728 TL	500
DEK 5 FW 101-150	Baskı 101 - 150	5,0 mm	0473460101	0,728 TL	500
DEK 5 FW 151-200	Baskı 151 - 200	5,0 mm	0473460151	0,728 TL	500
DEK 5 FW 201-250	Baskı 201 - 250	5,0 mm	0473460201	0,728 TL	500
DEK 5 FWZ 1-10	Baskı 1 - 10	5,0 mm	0523060001	0,728 TL	500
DEK 5 FWZ 11-20	Baskı 11 - 20	5,0 mm	0523060011	0,728 TL	500
DEK 5 FWZ 21-30	Baskı 21 - 30	5,0 mm	0523060021	0,728 TL	500
DEK 5 FWZ 31-40	Baskı 31 - 40	5,0 mm	0523060031	0,728 TL	500
DEK 5 FWZ 41-50	Baskı 41 - 50	5,0 mm	0523060041	0,728 TL	500
DEK 5 FWZ 51-60	Baskı 51 - 60	5,0 mm	0523060051	0,728 TL	500
DEK 5 FWZ 61-70	Baskı 61 - 70	5,0 mm	0523060061	0,728 TL	500
DEK 5 FWZ 71-80	Baskı 71 - 80	5,0 mm	0523060071	0,728 TL	500
DEK 5 FWZ 81-90	Baskı 81 - 90	5,0 mm	0523060081	0,728 TL	500
DEK 5 FWZ 91-100	Baskı 91 - 100	5,0 mm	0523060091	0,728 TL	500
DEK 5 GW +	Baskı +	5,0 mm	0576261198	0,728 TL	500
DEK 5 GW -	Baskı -	5,0 mm	0576261199	0,728 TL	500
DEK 5 GW ERDE	Baskı Toprak	5,0 mm	0576261202	0,728 TL	500
DEK 5 GW ERDE I.KR.	Baskı Toprak Yuvarlak İçinde	5,0 mm	0576261203	0,728 TL	500
DEK 5 GW L1	Baskı L1	5,0 mm	0522361075	0,728 TL	500
DEK 5 GW L2	Baskı L2	5,0 mm	0522361076	0,728 TL	500
DEK 5 GW L3	Baskı L3	5,0 mm	0522361077	0,728 TL	500
DEK 5 FWZ L1-PE	Baskı L1 - PE	5,0 mm	0354361187	0,728 TL	500
<b>DEK 6</b>					
DEK 6 FW 1-50	Baskı 1 - 50	6,0 mm	0468660001	0,728 TL	500
DEK 6 FW 51-100	Baskı 51 - 100	6,0 mm	0468660051	0,728 TL	500
DEK 6 FW 101-150	Baskı 101 - 150	6,0 mm	0468660101	0,728 TL	500
DEK 6 FW 151-200	Baskı 151 - 200	6,0 mm	0468660151	0,728 TL	500
DEK 6 FW 201-250	Baskı 201 - 250	6,0 mm	0468660201	0,728 TL	500
DEK 6 FWZ 1-10	Baskı 1 - 10	6,0 mm	0518960001	0,728 TL	500
DEK 6 FWZ 11-20	Baskı 11 - 20	6,0 mm	0518960011	0,728 TL	500
DEK 6 FWZ 21-30	Baskı 21 - 30	6,0 mm	0518960021	0,728 TL	500
DEK 6 FWZ 31-40	Baskı 31 - 40	6,0 mm	0518960031	0,728 TL	500
DEK 6 FWZ 41-50	Baskı 41 - 50	6,0 mm	0518960041	0,728 TL	500
DEK 6 FWZ 51-60	Baskı 51 - 60	6,0 mm	0518960051	0,728 TL	500
DEK 6 FWZ 61-70	Baskı 61 - 70	6,0 mm	0518960061	0,728 TL	500
DEK 6 FWZ 71-80	Baskı 71 - 80	6,0 mm	0518960071	0,728 TL	500
DEK 6 FWZ 81-90	Baskı 81 - 90	6,0 mm	0518960081	0,728 TL	500
DEK 6 FWZ 91-100	Baskı 91 - 100	6,0 mm	0518960091	0,728 TL	500
DEK 6 GW +	Baskı +	6,0 mm	1318061198	0,728 TL	500
DEK 6 GW -	Baskı -	6,0 mm	1318061199	0,728 TL	500
DEK 6 GW ERDE	Baskı Toprak	6,0 mm	1318061202	0,728 TL	500
DEK 6 FWZ L1-PE	Baskı L1 - PE	6,0 mm	0631961187	0,728 TL	500
DEK 6 FWZ L1-ERDE I.KRE	Baskı L1	6,0 mm	0631961203	0,728 TL	500
<b>DEK 8</b>					
DEK 8 FWZ 1-10	Baskı 1 - 10	8,0 mm	1276960001	0,773 TL	500
DEK 8 FWZ 11-20	Baskı 11 - 20	8,0 mm	1276960011	0,773 TL	500
DEK 8 FWZ 21-30	Baskı 21 - 30	8,0 mm	1276960021	0,773 TL	500
DEK 8 FWZ 31-40	Baskı 31 - 40	8,0 mm	1276960031	0,773 TL	500
DEK 8 FWZ 41-50	Baskı 41 - 50	8,0 mm	1276960041	0,773 TL	500



PRINTJET CONNECT



MCP BASIC 2



THM MULTIMARK



DEK 5/5 MC NE WS

Tip	Açıklama	Kesit	Sipariş No	Fiyat/Birim	Ambalaj
<b>CLI C - Kapalı - Açık Tip Kablo Markalama</b>					
<b>CLI C Kapalı Tip - PVC, VO (UL 94), Lazer baskı</b>					
CLI C 02/3	Baskılı	0.20 - 1.50 mm	025211xxxx	0,382 TL	200
CLI C 02-3 GE NE MP	Baskısız	0.20 - 1.50 mm	0213811687	0,382 TL	200
CLI C 01/3	Baskılı	1.50 - 4.00 mm	025261xxxx	0,382 TL	200
CLI C 1-3 GE NE MP	Baskısız	1.50 - 4.00 mm	0171111687	0,382 TL	200

Tip	Açıklama	Sipariş No	Fiyat/Birim	Ambalaj
<b>Markalama Cihazları</b>				
* PRINTJET CONNECT	İnkjet Yazıcı - Kablosuz haberleşmeli Multicard yazıcı	2715590000	7.000,00 €	1
PRINTJET ADVANCED 230V	İnkjet Yazıcı - Multicard yazıcı	1324380000	5.700,00 €	1
MCP BASIC 2	Plotter - Kalemli Multicard yazıcı	2438520000	4.400,00 €	1
THM MULTIMARK	Multimark yüzeyleri için termal transfer yazıcı	2599430000	2.200,00 €	1

<b>Cihaz Aksesuarları</b>				
PJ PRO TINTENSET FARBE	PrintJet Pro Renkli Set	1027110000	600,00 €	1
PJ PRO TNTK INK K	PrintJet Pro Siyah mürekkep	1027040000	133,00 €	1
PJ PRO TNTK INK C	PrintJet Pro Mavi mürekkep	1027050000	133,00 €	1
PJ PRO TNTK INK M	PrintJet Pro Kırmızı mürekkep	1027060000	133,00 €	1
PJ PRO TNTK INK Y	PrintJet Pro Sarı mürekkep	1027070000	133,00 €	1
PJ PRO TNAW	PrintJet Pro Atık mürekkep tankı	1024140000	280,00 €	1
PJ ADV TNTK INK SET	PrintJet Advanced Renkli Set	1338720000	570,00 €	1
PJ ADV TNTK INK K	PrintJet Advanced Siyah mürekkep	1338690000	160,00 €	1
PJ ADV TNTK INK C	PrintJet Advanced Mavi mürekkep	1338680000	160,00 €	1
PJ ADV TNTK INK M	PrintJet Advanced Kırmızı mürekkep	1338670000	160,00 €	1
PJ ADV TNTK INK Y	PrintJet Advanced Sarı mürekkep	1338650000	160,00 €	1
PJ ADV TNAW	PrintJet Advanced Atık mürekkep tankı	1338710000	262,00 €	1
MCP AP BASIC	Multikart taşıyıcı - Plotter için	1139880000	636,00 €	1
RIBBON MM 80/360 SW	THM MM ile uyumlu, Siyah renk, 80 cm genişlik, 360 m uzunluk	2005080000	140,00 €	1
RIBBON MM 110/360 SW	THM MM ile uyumlu, Siyah renk, 110 cm genişlik, 360 m uzunluk	2005070000	150,00 €	1
RIBBON MM 80/300 WS	THM MM ile uyumlu, Beyaz Renk, 80 cm genişlik, 360 m uzunluk	2005040000	420,00 €	1
RIBBON MM-TB 25/360 SW	THM MM ile uyumlu, Siyah Renk, 25 cm genişlik, 360 m uzunluk	2005090000	40,00 €	1
THM MMP CUTTER	Markalama kesme aparatı	1331600000	1.000,00 €	1
RIBBON THM HIRE	Termal yazıcı için ribbon	1790650000	256,00 €	1
RIBBON HSS HF EL 40/300	Termal yazıcı için ribbon 40/300 Daralan makaron için	1426210000	154,00 €	1
THM MMP EXT.RH	30 mt. Makaron için Taşıyıcı	1302920000	380,00 €	1
ADAPTER ALU STI-S	STI-S Kalem için	1762440000	48,00 €	1
STI Waterproof schwarz	Silinmez Kalem	0508401694	13,55 €	10

Tip	Ölçü	Sipariş No	Fiyat/Birim	Ambalaj
<b>Klemens Etiketleri - Multikart</b>				
DEK 5/5 MC NE WS	5 / 5 mm	1609801044	0,685 TL	1000
DEK 5/5 PLUS MC NE WS	5 / 5 mm	1854490000	0,685 TL	1000
DEK 5/5 S MC NE WS	5 / 5 mm	1341620000	0,813 TL	400
DEK 5/6 MC NE WS	5 / 6 mm	1609820000	0,687 TL	1000
DEK 5/6.5 MC NE WS	5 / 6,5 mm	1609840000	0,687 TL	900
DEK 5/7.5 MC NE WS	5 / 7,5 mm	1720620000	1,04 TL	320
DEK 5/8 MC NE WS	5 / 8 mm	1856740000	0,701 TL	800
WS 8/5 MC NE WS	8 / 5 mm	1640740000	1,19 TL	720
WS 8/5 PLUS MC NE WS	8 / 5 mm	1951870000	1,21 TL	600
WS 10/5 MC NE WS	10 / 5 mm	1635000000	1,19 TL	720
WS 12/5 MC NE WS	12 / 5 mm	1609860000	1,19 TL	720
WS 10/6 MC NE WS	10 / 6 mm	1828450000	1,19 TL	600
WS 12/6 MC NE WS	12 / 6 mm	1609900000	1,19 TL	600

Serinin devamı sayfa 36



MF 5/5 MC NE WS



SCHT 5 S



WAD 5 MC NE WS



SFC 0/12 MC NE WS

Tip	Ölçü	Sipariş No	Fiyat/Birim	Ambalaj
WS 10/8 PLUS MC NE WS	10 / 8 mm	1905950000	1,22 TL	420
WS 12/8 PLUS MC NE WS	12 / 8 mm	1906000000	1,22 TL	420
WS 10/12 MC NE WS	10 / 12 mm	1905970000	1,22 TL	300
WS 10/15 MC NE WS	10 / 15 mm	1854090000	1,37 TL	240
ZS 10/5 MC NE WS	10 / 5 mm	1610000000	1,56 TL	480
ZS 15/5 MC NE WS	15 / 5 mm	1646630000	1,56 TL	480

#### Klemens Etiketleri - Diğer Marka Klemensler için Multifit

MF 5/5 MC NE WS	5 / 5 mm	1816250000	1,06 TL	500
MF-W 5/5 MINI MC NE WS	5 / 5 mm	1816240000	1,06 TL	500
MF 8/5 MC NE WS	8 / 5 mm	1677140000	1,34 TL	600
MF 10/5 MC NE WS	10 / 5mm	1677160000	1,34 TL	600
MF 12/5 MC NE WS	12 / 5 mm	1677180000	1,34 TL	600
MF 5/6 MC NE WS	5 / 6 mm	1816260000	1,06 TL	500
MF-W 9/6 MC NE WS	9 / 6 mm	1816290000	1,34 TL	500
MF 10/6 MC NE WS	10 / 6 mm	1677220000	1,34 TL	600

Tip	Açıklama	En / Boy	Sipariş No	Fiyat/Birim	Ambalaj
<b>Klemens Grup Markalama TS 32 ve TS 35</b>					
SCHT 5	Klemens grup markalama	19,5 / 44,5 mm	0292460000	16,65 TL	20
SCHT 5 S	Klemens grup markalama	9,5 / 44,5 mm	1631930000	18,80 TL	20
EM 8/30	Şeffaf, klemens üzerine kaplayan	8 / mm30 mm	1806120000	12,45 TL	50

Tip	Açıklama	En / Renk	Sipariş No	Fiyat/Birim	Ambalaj
<b>Klemens Grup Markalama TS 32 ve TS 35</b>					
ESO 5 DIN A4 WS	SCHT 5 - A4 Kağıt Yazdırma Yüzeyi	60 / Beyaz	1607710000	31,60 TL	10
ESO 5 S DIN A4 WS	SCHT 5 S - A4 Kağıt Yazdırma Yüzeyi	60 / Beyaz	1631920000	31,60 TL	10
ESO 5 P DIN A4 WS	SCHT 5 - A4 Kağıt Yazdırma Yüzeyi	60 / Beyaz	1670370000	339,35 TL	10
ESO 5 P DIN A4 GE	SCHT 5 - A4 Kağıt Yazdırma Yüzeyi	60 / Sarı	1670380000	339,35 TL	10
ESO 5 DIN A4 GE	SCHT 5 - A4 Kağıt Yazdırma Yüzeyi	140 / Sarı	1631350000	31,60 TL	10

Tip	Renk	Ölçü / Adet	Sipariş No	Fiyat/Birim	Ambalaj
<b>WAD Multikard Klemens Grup Etiketleri</b>					
WAD 5 MC NE WS	Beyaz	5 mm / 12 adet	1112910000	3,16 TL	48
WAD 5 MC NE GE	Sarı	5 mm / 12 adet	1112920000	3,16 TL	48
WAD 8 MC NE WS	Beyaz	8 mm / 12 adet	1112940000	4,82 TL	48
WAD 8 MC NE GE	Sarı	8 mm / 12 adet	1112950000	4,82 TL	48
WAD 5 MC B GE/SW	Sarı "Enerji" İşareti baskılı 5 mm	5 mm / 12 adet	1120450000	5,71 TL	48
WAD 8 MC B GE/SW	Sarı "Enerji" İşareti baskılı 8 mm	8 mm / 12 adet	1120470000	5,71 TL	48

Tip	Renk	Kablo Kesit	Sipariş No	Fiyat/Birim	Ambalaj
<b>SlimFix Clip - Çıtırklı Kablo Markalama</b>					
<b>12 mm Uzunluk</b>					
SFC 0/12 MC NE WS	Beyaz / neutral	0,5 - 1,0 mm <sup>2</sup>	1813130000	1,67 TL	200
SFC 0/12 MC NE GE	Sarı / neutral	0,5 - 1,0 mm <sup>2</sup>	1813160000	1,67 TL	200
SFC 1/12 MC NE WS	Beyaz / neutral	0,75 - 2,5 mm <sup>2</sup>	1747320001	1,67 TL	200
SFC 1/12 MC NE GE	Sarı / neutral	0,75 - 2,5 mm <sup>2</sup>	1747320004	1,67 TL	200
SFC 2/12 MC NE WS	Beyaz / neutral	2,5 - 4,0 mm <sup>2</sup>	1758320001	1,86 TL	120
SFC 2/12 MC NE GE	Sarı / neutral	2,5 - 4,0 mm <sup>2</sup>	1758320004	1,86 TL	120
SFC 2.5/12 MC NE WS	Beyaz / neutral	4,0 - 6,0 mm <sup>2</sup>	1062000000	2,24 TL	120
SFC 2.5/12 MC NE GE	Sarı / neutral	4,0 - 6,0 mm <sup>2</sup>	1062010000	2,24 TL	120
SFC 3/12 MC NE WS	Beyaz / neutral	4,0 - 10,0 mm <sup>2</sup>	1025220000	2,54 TL	80
SFC 3/12 MC NE GE	Sarı / neutral	4,0 - 10,0 mm <sup>2</sup>	1025230000	2,54 TL	80



SFC 0/21 MC NE WS



SFC 0/30 MC NE WS



SF 00/12 MC NE WS V2



sf 4/12 MC NE GE V2

Tip	Renk	Kablo Kesit	Sipariş No	Fiyat/Birim	Ambalaj
<b>21 mm Uzunluk</b>					
SFC 0/21 MC NE WS	Beyaz / neutral	0,5 - 1,0 mm <sup>2</sup>	1813190000	1,86 TL	200
SFC 0/21 MC NE GE	Sarı / neutral	0,5 - 1,0 mm <sup>2</sup>	1813210000	1,86 TL	200
SFC 1/21 MC NE WS	Beyaz / neutral	0,75 - 2,5 mm <sup>2</sup>	1779080001	1,86 TL	200
SFC 1/21 MC NE GE	Sarı / neutral	0,75 - 2,5 mm <sup>2</sup>	1779080004	1,86 TL	200
SFC 2/21 MC NE WS	Beyaz / neutral	2,5 - 4,0 mm <sup>2</sup>	1805810000	2,03 TL	120
SFC 2/21 MC NE GE	Sarı / neutral	2,5 - 4,0 mm <sup>2</sup>	1805780000	2,03 TL	120
SFC 2.5/21 MC NE WS	Beyaz / neutral	4,0 - 6,0 mm <sup>2</sup>	1062050000	2,43 TL	120
SFC 2.5/21 MC NE GE	Sarı / neutral	4,0 - 6,0 mm <sup>2</sup>	1062070000	2,43 TL	120
SFC 3/21 MC NE WS	Beyaz / neutral	4,0 - 10,0 mm <sup>2</sup>	1025260000	2,82 TL	80
SFC 3/21 MC NE GE	Sarı / neutral	4,0 - 10,0 mm <sup>2</sup>	1025270000	2,82 TL	80
<b>30 mm Uzunluk</b>					
SFC 0/30 MC NE WS	Beyaz / neutral	0,5 - 1,0 mm <sup>2</sup>	1813240000	1,88 TL	150
SFC 0/30 MC NE GE	Sarı / neutral	0,5 - 1,0 mm <sup>2</sup>	1813260000	1,88 TL	150
SFC 1/30 MC NE WS	Beyaz / neutral	0,75 - 2,5 mm <sup>2</sup>	1805760000	1,88 TL	150
SFC 1/30 MC NE GE	Sarı / neutral	0,75 - 2,5 mm <sup>2</sup>	1805730000	1,88 TL	150
SFC 2/30 MC NE WS	Beyaz / neutral	2,5 - 4,0 mm <sup>2</sup>	1805870000	2,14 TL	90
SFC 2/30 MC NE GE	Sarı / neutral	2,5 - 4,0 mm <sup>2</sup>	1805830000	2,14 TL	90
SFC 3/30 MC NE WS	Beyaz / neutral	4,0 - 10,0 mm <sup>2</sup>	1025310000	3,16 TL	60
SFC 3/30 MC NE GE	Sarı / neutral	4,0 - 10,0 mm <sup>2</sup>	1025320000	3,16 TL	60
<b>SlimFix V2 - Kavramalı ve Geçmeli Tip Kablo Markalama</b>					
<b>12 mm Uzunluk</b>					
SF 00/12 MC NE WS V2	Beyaz / neutral	< 0,25 mm <sup>2</sup>	1919290000	1,56 TL	400
SF 00/12 MC NE GE V2	Sarı / neutral	< 0,25 mm <sup>2</sup>	1919260000	1,56 TL	400
SF 0/12 MC NE WS V2	Beyaz / neutral	0,25 - 0,5 mm <sup>2</sup>	1919240000	1,68 TL	400
SF 0/12 MC NE GE V2	Sarı / neutral	0,25 - 0,5 mm <sup>2</sup>	1919210000	1,68 TL	400
SF 1/12 MC NE WS V2	Beyaz / neutral	0,5 - 0,75 mm <sup>2</sup>	1919390000	1,68 TL	400
SFR 1/12 MC NE WS	Beyaz / neutral	0,5 - 0,75 mm <sup>2</sup>	1318640000	2,03 TL	400
SF 1/12 MC NE GE V2	Sarı / neutral	0,5 - 0,75 mm <sup>2</sup>	1919340000	1,68 TL	400
SFR 1/12 MC NE GE	Sarı / neutral	0,5 - 0,75 mm <sup>2</sup>	1318650000	2,14 TL	400
SF 2/12 MC NE WS V2	Beyaz / neutral	0,75 - 1,5 mm <sup>2</sup>	1919490000	1,80 TL	400
SFR 2/12 MC NE WS	Beyaz / neutral	0,75 - 1,5 mm <sup>2</sup>	1318660000	2,24 TL	400
SF 2/12 MC NE GE V2	Sarı / neutral	0,75 - 1,5 mm <sup>2</sup>	1919470000	1,80 TL	400
SFR 2/12 MC NE GE	Sarı / neutral	0,75 - 1,5 mm <sup>2</sup>	1318670000	2,24 TL	400
SF 3/12 MC NE WS V2	Beyaz / neutral	1,5 - 2,5 mm <sup>2</sup>	1919540000	1,88 TL	320
SFR 3/12 MC NE WS	Beyaz / neutral	1,5 - 2,5 mm <sup>2</sup>	1318680000	2,34 TL	256
SF 3/12 MC NE GE V2	Sarı / neutral	1,5 - 2,5 mm <sup>2</sup>	1919520000	1,89 TL	320
SFR 3/12 MC NE GE	Sarı / neutral	1,5 - 2,5 mm <sup>2</sup>	1318690000	2,43 TL	256
SF 4/12 MC NE WS V2	Beyaz / neutral	2,5 - 4,0 mm <sup>2</sup>	1919600000	1,96 TL	128
SF 4/12 MC NE GE V2	Sarı / neutral	2,5 - 4,0 mm <sup>2</sup>	1919580000	1,96 TL	128
SF 5/12 MC NE WS V2	Beyaz / neutral	6,0 - 10,0 mm <sup>2</sup>	1919650000	2,54 TL	160
SF 5/12 MC NE GE V2	Sarı / neutral	6,0 - 10,0 mm <sup>2</sup>	1919620000	2,54 TL	160
<b>21 mm Uzunluk</b>					
SF 00/21 MC NE WS V2	Beyaz / neutral	< 0,25 mm <sup>2</sup>	1918580000	1,56 TL	400
SF 00/21 MC NE GE V2	Sarı / neutral	< 0,25 mm <sup>2</sup>	1918560000	1,56 TL	400
SF 0/21 MC NE WS V2	Beyaz / neutral	0,25 - 0,5 mm <sup>2</sup>	1918500000	1,68 TL	400
SF 0/21 MC NE GE V2	Sarı / neutral	0,25 - 0,5 mm <sup>2</sup>	1918480000	1,68 TL	400
SF 1/21 MC NE WS V2	Beyaz / neutral	0,5 - 0,75 mm <sup>2</sup>	1918630000	1,80 TL	400
SFR 1/21 MC NE WS	Beyaz / neutral	0,5 - 0,75 mm <sup>2</sup>	1318710000	2,24 TL	400
SF 1/21 MC NE GE V2	Sarı / neutral	0,5 - 0,75 mm <sup>2</sup>	1918610000	1,80 TL	400

Serinin devamı sayfa 38





SFX 10/23 MC NE WS V2



SF-TOOL 00-6



SFX 14/23 MC NE GE V2



TM-I 12 MC NE WS

Tip	Renk	Kablo Kesit	Sipariş No	Fiyat/Birim	Ambalaj
SFR 1/21 MC NE GE	Sarı / neutral	0,5 - 0,75 mm <sup>2</sup>	1318720000	2,24 TL	400
SF 2/21 MC NE WS V2	Beyaz / neutral	0,75 - 1,5 mm <sup>2</sup>	1918690000	1,89 TL	400
SFR 2/21 MC NE WS	Beyaz / neutral	0,75 - 1,5 mm <sup>2</sup>	1318730000	2,34 TL	400
SF 2/21 MC NE GE V2	Sarı / neutral	0,75 - 1,5 mm <sup>2</sup>	1918660000	1,89 TL	400
SFR 2/21 MC NE GE	Sarı / neutral	0,75 - 1,5 mm <sup>2</sup>	1318740000	2,34 TL	400
SF 3/21 MC NE WS V2	Beyaz / neutral	1,5 - 2,5 mm <sup>2</sup>	1918910000	2,03 TL	320
SFR 3/21 MC NE WS	Beyaz / neutral	1,5 - 2,5 mm <sup>2</sup>	1318750000	2,43 TL	256
SF 3/21 MC NE GE V2	Sarı / neutral	1,5 - 2,5 mm <sup>2</sup>	1918890000	2,03 TL	320
SFR 3/21 MC NE GE	Sarı / neutral	1,5 - 2,5 mm <sup>2</sup>	1318760000	2,34 TL	256
SF 4/21 MC NE WS V2	Beyaz / neutral	2,5 - 4,0 mm <sup>2</sup>	1919080000	2,03 TL	192
SF 4/21 MC NE GE V2	Sarı / neutral	2,5 - 4,0 mm <sup>2</sup>	1919060000	2,03 TL	192
SF 4.5/21 MC NE WS V2	Beyaz / neutral	4,0 - 6,0 mm <sup>2</sup>	1919020000	2,96 TL	96
SF 4.5/21 MC NE GE V2	Sarı / neutral	4,0 - 6,0 mm <sup>2</sup>	1919000000	2,96 TL	96
SF 5/21 MC NE WS V2	Beyaz / neutral	6,0 - 10,0 mm <sup>2</sup>	1919140000	3,49 TL	160
SF 5/21 MC NE GE V2	Sarı / neutral	6,0 - 10,0 mm <sup>2</sup>	1919120000	3,49 TL	160
SF 6/21 MC NE WS V2	Beyaz / neutral	10,0 - 16,0 mm <sup>2</sup>	1919190000	4,44 TL	160
SF 6/21 MC NE GE V2	Sarı / neutral	10,0 - 16,0 mm <sup>2</sup>	1919170000	4,44 TL	160

**SFX Kablo Bağı ile montaj**

SFX 10/23 MC NE WS V2	Beyaz / neutral	16,0 mm <sup>2</sup>	1852390000	6,12 TL	160
SFX 10/23 MC NE GE V2	Sarı / neutral	16,0 mm <sup>2</sup>	1852360000	6,12 TL	160
SFX 14/23 MC NE WS V2	Beyaz / neutral	16,0 mm <sup>2</sup>	1852440000	6,12 TL	160
SFX 14/23 MC NE GE V2	Sarı / neutral	16,0 mm <sup>2</sup>	1852410000	6,12 TL	160
SFX 9/24 MC NE WS V2	Beyaz / neutral	16,0 mm <sup>2</sup>	1852490000	6,12 TL	160
SFX 9/24 MC NE GE V2	Sarı / neutral	16,0 mm <sup>2</sup>	1852460000	6,12 TL	160
SFX 11/60 MC NE WS	Beyaz / neutral	16,0 mm <sup>2</sup>	1860120000	6,12 TL	60
SFX 11/60 MC NE GE	Sarı / neutral	16,0 mm <sup>2</sup>	1860150000	6,12 TL	60
SFX 30/60 MC NE WS	Beyaz / neutral	40 mm <sup>2</sup> ve üstü ölçüler için	1083230000	6,45 TL	30
SFX 30/60 MC NE GE	Sarı / neutral	40 mm <sup>2</sup> ve üstü ölçüler için	1083240000	6,45 TL	30

Tip	Açıklama	Sipariş No	Fiyat/Birim	Ambalaj
<b>SF - TOOL</b>				
SF-TOOL 00-6	SlimFix	1950820000	1,00 €	10
SF-TOOL 1	SlimFix	1782970000	0,75 €	10
SF-TOOL 2-3	SlimFix	1782960000	0,90 €	10
SF-TOOL 4-5	SlimFix	1782980000	0,90 €	10

Tip	Renk	Sipariş No	Fiyat/Birim	Ambalaj
<b>TM-I - Etiket</b>				
TM-I 12 MC NE WS	Beyaz	1718411044	1,50 TL	320
TM-I 12 MC NE GE	Sarı	1718411687	1,50 TL	320
TM-I 15 MC NE WS	Beyaz	1609981044	1,57 TL	400
TM-I 15 MC NE GE	Sarı	1609981687	1,57 TL	400
TM-I 18 MC NE WS	Beyaz	1718431044	1,68 TL	320
TM-I 18 MC NE GE	Sarı	1718431687	1,68 TL	320
TM-I 20 MC NE WS	Beyaz	1680411044	1,68 TL	400
TM-I 20 MC NE GE	Sarı	1680411687	1,68 TL	400
TM-I 30 MC NE WS	Beyaz	1876390000	1,68 TL	300
TM-I 30 MC NE GE	Sarı	1876370000	1,68 TL	300

Tip	Uzunluk	Kablo Kesit	Sipariş No	Fiyat/Birim	Ambalaj
<b>TM Şeffaf Kılıflar</b>					
TM 201/12 VO	12 mm	0.25 - 1.5 mm <sup>2</sup>	1798640000	0,352 TL	1000
TM 201/15 VO	15 mm	0.25 - 1.5 mm <sup>2</sup>	1798620000	0,352 TL	1000
TM 201/18 VO	18 mm	0.25 - 1.5 mm <sup>2</sup>	1798600000	0,492 TL	1000
TM 201/20 VO	20 mm	0.25 - 1.5 mm <sup>2</sup>	1798580000	0,492 TL	1000
TM 201/30 VO	30 mm	0.25 - 1.5 mm <sup>2</sup>	1874850000	0,661 TL	500
TM 202/12 VO	12 mm	0.5 - 2.5 mm <sup>2</sup>	1798560000	0,377 TL	1000
TM 202/15 VO	15 mm	0.5 - 2.5 mm <sup>2</sup>	1798540000	0,377 TL	1000
TM 202/18 VO	18 mm	0.5 - 2.5 mm <sup>2</sup>	1798530000	0,517 TL	1000
TM 202/20 VO	20 mm	0.5 - 2.5 mm <sup>2</sup>	1798520000	0,517 TL	1000
TM 202/30 VO	30 mm	0.5 - 2.5 mm <sup>2</sup>	1874760000	0,773 TL	500
TM 203/12 VO	12 mm	2.5 - 10 mm <sup>2</sup>	1798510000	0,449 TL	500
TM 203/15 VO	15 mm	2.5 - 10 mm <sup>2</sup>	1798490000	0,449 TL	500
TM 203/18 VO	18 mm	2.5 - 10 mm <sup>2</sup>	1798480000	0,644 TL	500
TM 203/20 VO	20 mm	2.5 - 10 mm <sup>2</sup>	1798470000	0,644 TL	500
TM 203/30 VO	30 mm	2.5 - 10 mm <sup>2</sup>	1874770000	0,996 TL	200
TM 204/12 VO	12 mm	6 - 16 mm <sup>2</sup>	1806180000	0,532 TL	500
TM 204/15 VO	15 mm	6 - 16 mm <sup>2</sup>	1806240000	0,532 TL	500
TM 204/18 VO	18 mm	6 - 16 mm <sup>2</sup>	1806300000	0,758 TL	500
TM 204/20 VO	20 mm	6 - 16 mm <sup>2</sup>	1806360000	0,758 TL	500
TM 204/30 VO	30 mm	6 - 16 mm <sup>2</sup>	1874780000	1,29 TL	200
TM 205/12 VO	12 mm	16 - 35 mm <sup>2</sup>	1806190000	1,23 TL	200
TM 205/15 VO	15 mm	16 - 35 mm <sup>2</sup>	1806250000	1,42 TL	200
TM 205/18 VO	18 mm	16 - 35 mm <sup>2</sup>	1806310000	1,56 TL	200
TM 205/20 VO	20 mm	16 - 35 mm <sup>2</sup>	1806370000	1,66 TL	200
TM 205/30 VO	30 mm	16 - 35 mm <sup>2</sup>	1874790000	2,69 TL	200
<b>CLI T Şeffaf Kılıflar</b>					
CLI T 02-12	12 mm	0.22 - 1.5 mm <sup>2</sup>	1764060000	0,449 TL	200
CLI T 02-15	15 mm	0.22 - 1.5 mm <sup>2</sup>	1764070000	0,449 TL	200
CLI T 02-18	18 mm	0.22 - 1.5 mm <sup>2</sup>	1764140000	0,449 TL	200
CLI T 02-20	20 mm	0.22 - 1.5 mm <sup>2</sup>	1764150000	0,604 TL	200
CLI T 02-30	30 mm	0.22 - 1.5 mm <sup>2</sup>	1889580000	0,604 TL	200
CLI T 1-12	12 mm	0.75 - 6 mm <sup>2</sup>	1764190000	0,492 TL	200
CLI T 1-15	15 mm	0.75 - 6 mm <sup>2</sup>	1764200000	0,492 TL	200
CLI T 1-18	18 mm	0.75 - 6 mm <sup>2</sup>	1764210000	0,492 TL	200
CLI T 1-20	20 mm	0.75 - 6 mm <sup>2</sup>	1764220000	0,715 TL	200
CLI T 1-30	30 mm	0.75 - 6 mm <sup>2</sup>	1889560000	0,715 TL	200
CLI T 2-12	12 mm	4 - 35 mm <sup>2</sup>	1764230000	1,12 TL	100
CLI T 2-15	15 mm	4 - 35 mm <sup>2</sup>	1764240000	1,12 TL	100
CLI T 2-18	18 mm	4 - 35 mm <sup>2</sup>	1764250000	1,12 TL	100
CLI T 2-20	20 mm	4 - 35 mm <sup>2</sup>	1764260000	1,12 TL	100
CLI T 2-30	30 mm	4 - 35 mm <sup>2</sup>	1889570000	1,64 TL	100
CLI T 3-12	12 mm	25 - 75 mm <sup>2</sup>	1764270000	2,14 TL	100
CLI T 3-15	15 mm	25 - 75 mm <sup>2</sup>	1764280000	2,14 TL	100
CLI T 3-18	18 mm	25 - 75 mm <sup>2</sup>	1764290000	2,14 TL	100
CLI T 3-20	20 mm	25 - 75 mm <sup>2</sup>	1764300000	2,14 TL	100
CLI T 3-30	30 mm	25 - 75 mm <sup>2</sup>	1889550000	2,14 TL	100
<b>DMC 12/27 - Kablo Markalama</b>					
DMC 12/27 MC NE WS	12,0 x 27,0 mm	0,5 - 10,0 mm <sup>2</sup>	1016030000	3,16 TL	50
DMC 12/27 MC NE GE	12,0 x 27,0 mm	0,5 - 10,0 mm <sup>2</sup>	1018190000	3,16 TL	50



TM 201/12 VO



TM 201/18 VO



CLI T 02-12



DMC 12/27 MC NE WS



SM 27/8 MC NE WS



SM 27/18 K MC NE WS



SM 45/45-24 MC NE WS



CC 15/17 MC NE WS

Tip	Renk	Açıklama	Sipariş No	Fiyat/Birim	Ambalaj
<b>SwitchMark SM - Push Butonlar İçin</b>					
SM 27/8 MC NE WS	Beyaz	Yapışkansız	1699820000	4,91 TL	80
SM 27/8 MC NE SI	Gri	Yapışkansız	1713680000	4,91 TL	80
SM 27/8 K MC NE WS	Beyaz	Yapışkanlı	1812630000	9,00 TL	80
SM 27/8 K MC NE SI	Gri	Yapışkanlı	1771930000	9,00 TL	80
SM 27/12.5 MC NE WS	Beyaz	Yapışkansız	1699840000	5,24 TL	80
SM 27/12.5 MC NE SI	Gri	Yapışkansız	1713700000	5,24 TL	80
SM 27/12.5 K MC NE WS	Beyaz	Yapışkanlı	1699880000	8,74 TL	80
SM 27/12.5 K MC NE SI	Gri	Yapışkanlı	1713720000	8,74 TL	80
SM-H 27/12.5 SW	Siyah	Taşıyıcı	1716640000	6,65 TL	25
SM 27/18 MC NE WS	Beyaz	Yapışkansız	1699860000	5,58 TL	80
SM 27/18 MC NE SI	Gri	Yapışkansız	1713740000	5,58 TL	80
SM 27/18 K MC NE WS	Beyaz	Yapışkanlı	1707270000	8,74 TL	80
SM 27/18 K MC NE SI	Gri	Yapışkanlı	1713760000	8,74 TL	80
SM-H 27/18 SW	Siyah	Taşıyıcı	1716630000	6,79 TL	25
SM 27/27 MC NE WS	Beyaz	Yapışkansız	1773220000	5,58 TL	60
SM 27/27 MC NE SI	Gümüş	Yapışkansız	1773230000	5,58 TL	60
SM 27/27 K MC NE WS	Beyaz	Yapışkanlı	1783000000	8,74 TL	60
SM 27/27 K MC NE SI	Gri	Yapışkanlı	1782990000	8,74 TL	60
SM-H 27/27 SW	Siyah	Taşıyıcı	1782710000	7,06 TL	10
SM 18/9.5 K MC NE WS	Beyaz	Yapışkanlı	1248580000	8,40 TL	200
SM 18/9.5 K MC NE GE	Sarı	Yapışkanlı	1248590000	8,40 TL	200
SM 18/9.5 K MC NE GR	Gri	Yapışkanlı	1248610000	8,40 TL	200
SM 19/42 K MC NE WS	Beyaz	Yapışkanlı	1248620000	11,55 TL	40
SM 19/42 K MC NE GE	Sarı	Yapışkanlı	1248630000	11,55 TL	40
SM 19/42 K MC NE GR	Gri	Yapışkanlı	1248640000	11,55 TL	40
SM 45/45-24 MC NE WS	Beyaz	Yapışkansız	1248650000	16,85 TL	20
SM 45/45-24 MC NE GE	Sarı	Yapışkansız	1248660000	16,85 TL	20
SM 45/45-24 MC NE GR	Gri	Yapışkansız	1248670000	16,85 TL	20
<b>ClipCard Multikartları</b>					
CC 15/17 MC NE WS	Beyaz	Yapışkansız	1876570000	3,76 TL	80
CC 15/17 MC NE SI	Gri	Yapışkansız	1876610000	3,76 TL	80
CC 15/17 K MC NE WS	Beyaz	Yapışkanlı	1876590000	4,03 TL	80
CC 15/17 K MC NE SI	Gri	Yapışkanlı	1876580000	4,03 TL	80
CC-H 15/17	Siyah	Taşıyıcı	1790430000	10,50 TL	75
CC 15/27 MC NE WS	Beyaz	Yapışkansız	1876770000	4,03 TL	80
CC 15/27 MC NE SI	Gri	Yapışkansız	1876760000	4,03 TL	80
CC 15/27 K MC NE WS	Beyaz	Yapışkanlı	1876640000	4,44 TL	80
CC 15/27 K MC NE SI	Gri	Yapışkanlı	1876780000	4,44 TL	80
CC-H 15/27	Siyah	Taşıyıcı	1790410000	10,80 TL	45
CC 15/49 MC NE WS	Beyaz	Yapışkansız	1877260000	4,44 TL	40
CC 15/49 MC NE SI	Gri	Yapışkansız	1877240000	4,44 TL	40
CC 15/49 K MC NE WS	Beyaz	Yapışkanlı	1877220000	5,58 TL	40
CC 15/49 K MC NE SI	Gri	Yapışkanlı	1877270000	5,58 TL	40
CC-H 15/49	Siyah	Taşıyıcı	1790420000	11,80 TL	25
CC 15/60 MC NE WS	Beyaz	Yapışkansız	1877350000	5,11 TL	40
CC 15/60 MC NE SI	Gri	Yapışkansız	1877340000	5,11 TL	40
CC 15/60 K MC NE WS	Beyaz	Yapışkanlı	1877310000	5,85 TL	40
CC 15/60 K MC NE SI	Gri	Yapışkanlı	1877360000	5,85 TL	40
CC-H 15/60	Siyah	Taşıyıcı	1878910000	13,35 TL	25
CC 30/60 MC NE WS	Beyaz	Yapışkansız	1934420000	5,58 TL	30

Serinin devamı sayfa 41



CC 85/54 MC NE WS



ESG 6/15 K MC NE WS

Tip	Renk	Açıklama	Sipariş No	Fiyat/Birim	Ambalaj
CC 30/60 MC NE SI	Gri	Yapışkansız	1934400000	5,58 TL	30
CC 30/60 K MC NE WS	Beyaz	Yapışkanlı	1934390000	5,85 TL	30
CC 30/60 K MC NE SI	Gri	Yapışkanlı	1934330000	5,85 TL	30
CC-H 30/60	Siyah	Taşıyıcı	1934430000	14,00 TL	10
CC 85/54 MC NE WS	Beyaz	Yapışkansız	1138400000	23,25 TL	10
CC 85/54 MC NE GR	Gri	Yapışkansız	1138420000	23,25 TL	10
CC 85/54 K MC NE WS	Beyaz	Yapışkanlı	1138430000	27,20 TL	10
CC 85/54 K MC NE GR	Gri	Yapışkanlı	1138450000	27,20 TL	10

**ESG Cihaz Markalama - Multikart**

ESG 6/15 K MC NE WS	Beyaz	Yapışkanlı	1880100000	3,02 TL	200
ESG 6/15 K MC NE GE	Sarı	Yapışkanlı	1880130000	4,97 TL	200
ESG 6/15 RIDER MC NE WS	Beyaz	Yapışkanlı	1881280000	0,899 TL	200
ESG 6/17 K MC NE WS	Beyaz	Yapışkanlı	1880120000	3,02 TL	200
ESG 6/17 K MC NE GE	Sarı	Yapışkanlı	1880110000	3,02 TL	200
ESG 7/20 SIRIUS MC NE WS	Beyaz	Yapışkansız	1736181044	2,64 TL	200
ESG 7/20 SIRIUS MC NE TU	Turkuaz	Yapışkansız	1736181696	2,64 TL	200
ESG 8/17 MC NE WS	Beyaz	Yapışkansız	1674740000	2,43 TL	200
ESG 9/11 K MC NE WS	Beyaz	Yapışkanlı	1857440000	3,16 TL	200
ESG 9/17 K MC NE WS	Beyaz	Yapışkanlı	1674760000	4,03 TL	200
ESG 9/17 K MC NE GE	Sarı	Yapışkanlı	1753500000	3,56 TL	200
ESG 9/20 MC NE WS	Beyaz	Yapışkansız	1609940000	2,54 TL	200
ESG 9/20 MC NE TK	Turkuaz	Yapışkansız	1866690000	2,54 TL	200

Tip	Açıklama	Sipariş No	Fiyat/Birim	Ambalaj
-----	----------	------------	-------------	---------

**Metal Markalama**

CC-M 85/54 AL	Alüminyum Metal Kart	1327600000	71,80 TL	40
CC-M 85/54 ST	Paslanmaz Çelik Metal Kart	1327620000	107,90 TL	40
CC-M 27/18 AL	Alüminyum Metal Kart	1327630000	14,20 TL	200
CC-M 27/18 ST	Paslanmaz Çelik Metal Kart	1327640000	19,95 TL	200
CC-M 85/27 AL	Alüminyum Metal Kart	1327650000	44,95 TL	80
CC-M 85/27 ST	Paslanmaz Çelik Metal Kart	1327670000	57,80 TL	80
CC-M 30/60 ST	Paslanmaz Çelik Metal Kart	1327690000	44,35 TL	100
CC-M 15/60 AL	Alüminyum Metal Kart	1327700000	17,60 TL	200
CC-M 15/60 ST	Paslanmaz Çelik Metal Kart	1327720000	24,45 TL	200
CC-M 15/45 AL	Alüminyum Metal Kart	1327730000	14,55 TL	200
CC-M 15/45 ST	Paslanmaz Çelik Metal Kart	1327740000	21,50 TL	200
CC-M DIA 30 AL	Alüminyum Metal Kart	1327750000	17,60 TL	200
CC-M DIA 30 ST	Paslanmaz Çelik Metal Kart	1327770000	23,25 TL	200
SFX-M 11/60 AL	Alüminyum Metal Kart - Kablo Markalaması	1327780000	21,50 TL	50
SFX-M 11/60 ST	Paslanmaz Çelik Metal Kart - Kablo Markalaması	1327790000	26,95 TL	50
CC-M 85/54 4X3 AL	Üzerinde 4 Adet Puntolama Deliği Olan Alüminyum Tip	1327800000	71,80 TL	40
CC-M 85/54 4X3 ST	Üzerinde 4 Adet Puntolama Deliği Olan Paslanmaz Çelik Tip	1327820000	107,90 TL	40
CC-M 85/27 2X3 AL	Üzerinde 2 Adet Puntolama Deliği Olan Alüminyum Tip	1327830000	44,95 TL	80
CC-M 85/27 2X3 ST	Üzerinde 2 Adet Puntolama Deliği Olan Paslanmaz Çelik Tip	1327840000	57,80 TL	80
CC-M 30/60 2X3 AL	Üzerinde 2 Adet Puntolama Deliği Olan Alüminyum Tip	1327850000	35,15 TL	100
CC-M 30/60 2X3 ST	Üzerinde 2 Adet Puntolama Deliği Olan Paslanmaz Çelik Tip	1327870000	44,35 TL	100
CC-M 15/60 2X3 AL	Üzerinde 2 Adet Puntolama Deliği Olan Alüminyum Tip	1327880000	17,60 TL	200
CC-M 15/60 2X3 ST	Üzerinde 2 Adet Puntolama Deliği Olan Paslanmaz Çelik Tip	1327890000	24,45 TL	200
CC-M 15/45 2X3 AL	Üzerinde 2 Adet Puntolama Deliği Olan Alüminyum Tip	1327900000	14,55 TL	200
CC-M 15/45 2X3 ST	Üzerinde 2 Adet Puntolama Deliği Olan Paslanmaz Çelik Tip	1327920000	21,50 TL	200
DKB CC 85/54	Metal Kartlar İçin Yapışkanlı Bant	1175850000	20,55 TL	100

Serinin devamı sayfa 42



DKB CC 27/18



INLAY CC-M 15/45



THM MT30X 15/6 WS



THM GEW 15/6 GE



WS 8/8 MM BP WS



MF 10/6 MM WS

Tip	Açıklama	Sipariş No	Fiyat/Birim	Ambalaj
DKB CC 85/27	Metal Kartlar İçin Yapışkanlı Bant	1226620000	16,05 TL	100
CC-M 30/60 AL	Alüminyum Metal Kart	1327680000	35,15 TL	100
DKB CC 30/60	Metal Kartlar İçin Yapışkanlı Bant	1341130000	6,72 TL	100
DKB CC 27/18	Metal Kartlar İçin Yapışkanlı Bant	1341140000	2,82 TL	320
DKB CC 15/60	Metal Kartlar İçin Yapışkanlı Bant	1341150000	4,97 TL	160
DKB CC 15/45	Metal Kartlar İçin Yapışkanlı Bant	1341170000	4,03 TL	240
DKB CC DIA 30	Metal Kartlar İçin Yapışkanlı Bant	1341180000	4,30 TL	200
* SFX-M 11/60-5 AL	Metal Kablo Markalama , 7 - 40 mm, 60 x 11 mm /Alüminyum	1422560000	28,95 TL	50
* SFX-M 11/60-5 ST	Metal Kablo Markalama , 7 - 40 mm, 60 x 11 mm / Paslanmaz Çelik	1422570000	36,20 TL	50
INLAY CC-M 85/54	Metal Kartlar İçin Taşıyıcı Aparat	1341030000	2.009,00 TL	1
INLAY CC-M 27/18	Metal Kartlar İçin Taşıyıcı Aparat	1341040000	2.009,00 TL	1
INLAY CC-M 85/27	Metal Kartlar İçin Taşıyıcı Aparat	1341050000	2.009,00 TL	1
INLAY CC-M 30/60	Metal Kartlar İçin Taşıyıcı Aparat	1341070000	2.009,00 TL	1
INLAY CC-M 15/60	Metal Kartlar İçin Taşıyıcı Aparat	1341080000	2.009,00 TL	1
INLAY CC-M 15/45	Metal Kartlar İçin Taşıyıcı Aparat	1341090000	2.009,00 TL	1
INLAY CC-M DIA 30	Metal Kartlar İçin Taşıyıcı Aparat	1341100000	2.009,00 TL	1
INLAY SFX-M 11/60	Metal Kartlar İçin Taşıyıcı Aparat	1341110000	2.009,00 TL	1
INLAY CC-M UNIVERSAL	Metal Kartlar İçin Taşıyıcı Aparat	1341120000	3.013,00 TL	1

Tip	Açıklama	Renk / Materyal	Sipariş No	Fiyat/Birim	Ambalaj
<b>THM - Cihaz ve İletken Markalaması</b>					
THM MT30X 15/6 WS	10.000 / Rulo	Beyaz - Polyester Film	1753231044	3.828,00 TL	1
THM MT30X 15/6 GE	10.000 / Rulo	Sarı - Polyester Film	1753231687	3.828,00 TL	1
THM MT30X 17/9 WS	10.000 / Rulo	Beyaz - Polyester Film	1968130000	4.180,00 TL	1
THM MT30X 17/9 GE	10.000 / Rulo	Sarı - Polyester Film	1856650000	4.180,00 TL	1
THM MT30X 20/8 WS	10.000 / Rulo	Beyaz - Polyester Film	1753241044	3.828,00 TL	1
THM MT30X 20/8 GE	10.000 / Rulo	Sarı - Polyester Film	1753241687	3.828,00 TL	1
THM MT30X 25/12 WS	10.000 / Rulo	Beyaz - Polyester Film	1751751044	6.282,00 TL	1
THM MT30X 25/12 GE	10.000 / Rulo	Sarı - Polyester Film	1751751687	6.282,00 TL	1
THM MT30X 45/23 WS	2.000 / Rulo	Beyaz - Polyester Film	1751811044	3.360,00 TL	1
THM MT30X 45/23 GE	2.000 / Rulo	Sarı - Polyester Film	1751811687	3.360,00 TL	1
THM MT30X 65/35 WS	1.000 / Rulo	Beyaz - Polyester Film	1751831044	2.975,00 TL	1
THM MT30X 65/35 GE	1.000 / Rulo	Sarı - Polyester Film	1751831687	2.975,00 TL	1
THM GEW 15/6 WS	10.000 / Rulo	Beyaz - Tekstil Kağıdı	1059780000	4.726,00 TL	1
THM GEW 15/6 GE	10.000 / Rulo	Sarı - Tekstil Kağıdı	1059790000	4.726,00 TL	1
THM GEW 17/9 WS	10.000 / Rulo	Beyaz - Tekstil Kağıdı	1059800000	4.726,00 TL	1
THM GEW 17/9 GE	10.000 / Rulo	Sarı - Tekstil Kağıdı	1059810000	4.726,00 TL	1
THM GEW 20/8 WS	10.000 / Rulo	Beyaz - Tekstil Kağıdı	1059870000	4.726,00 TL	1
THM GEW 20/8 GE	10.000 / Rulo	Sarı - Tekstil Kağıdı	1059880000	4.726,00 TL	1

Tip	Renk	Birlikte Kullanılacak Ribon	Sipariş No	Fiyat/Birim	Ambalaj
<b>Multimark Etiket Grupları</b>					
<b>Klemens Markalama DEK, WS</b>					
DEK 5/3.5 MM WS	Beyaz	RIBBON MM-TB 25/360 SW	2007100000	0,381 TL	1000
DEK 5/5 MM WS	Beyaz	RIBBON MM-TB 25/360 SW	2007110000	0,392 TL	800
DEK 5/6 MM WS	Beyaz	RIBBON MM-TB 25/360 SW	2007120000	0,392 TL	600
DEK 5/8 MM WS	Beyaz	RIBBON MM-TB 25/360 SW	2007130000	0,426 TL	500
WS 8/3.5 MM WS	Beyaz	RIBBON MM-TB 25/360 SW	2007140000	0,461 TL	1000
WS 8/5 MM WS	Beyaz	RIBBON MM-TB 25/360 SW	2007150000	0,470 TL	800
WS 8/6 MM WS	Beyaz	RIBBON MM-TB 25/360 SW	2007160000	0,493 TL	600
WS 8/8 MM WS	Beyaz	RIBBON MM-TB 25/360 SW	2007170000	0,517 TL	500
* WS 8/8 MM BP WS	Beyaz	RIBBON MM-TB 25/360 SW	2619830000	0,567 TL	5000
* MF 10/6 MM WS	Beyaz	RIBBON MM-TB 25/360 SW	2519180000	1,23 TL	500

Serinin devamı sayfa 43



MF 10/8 MM WS

Tip	Renk	Birlikte Kullanılacak Ribon	Sipariş No	Fiyat/Birim	Ambalaj
* MF 10/8 MM WS	Beyaz	RIBBON MM-TB 25/360 SW	2519190000	1,17 TL	400
WS 12/3.5 MM WS	Beyaz	RIBBON MM-TB 25/360 SW	2007180000	0,493 TL	1000
WS 12/5 MM WS	Beyaz	RIBBON MM-TB 25/360 SW	2007190000	0,511 TL	800
WS 12/6 MM WS	Beyaz	RIBBON MM-TB 25/360 SW	2007200000	0,515 TL	600
WS 12/8 MM WS	Beyaz	RIBBON MM-TB 25/360 SW	2007210000	0,560 TL	500

## Kablo Markalama TM-I

TM-I 12 MM BL	Mavi	RIBBON MM 80/360 SW	2005890000	0,800 TL	2000
TM-I 12 MM GE	Sarı	RIBBON MM 80/360 SW	2005550000	0,896 TL	2000
TM-I 12 MM RT	Kırmızı	RIBBON MM 80/360 SW	2005730000	0,800 TL	2000
TM-I 12 MM WS	Beyaz	RIBBON MM 80/360 SW	2005440000	0,800 TL	2000
TM-I 15 MM BL	Mavi	RIBBON MM 80/360 SW	2005910000	0,952 TL	2000
TM-I 15 MM GE	Sarı	RIBBON MM 80/360 SW	2005580000	0,952 TL	2000
TM-I 15 MM RT	Kırmızı	RIBBON MM 80/360 SW	2005760000	0,952 TL	2000
TM-I 15 MM WS	Beyaz	RIBBON MM 80/360 SW	2005450000	0,952 TL	2000
TM-I 18 MM BL	Mavi	RIBBON MM 80/360 SW	2005930000	0,996 TL	2000
TM-I 18 MM GE	Sarı	RIBBON MM 80/360 SW	2005610000	0,996 TL	2000
TM-I 18 MM RT	Kırmızı	RIBBON MM 80/360 SW	2005790000	0,996 TL	2000
TM-I 18 MM WS	Beyaz	RIBBON MM 80/360 SW	2005470000	0,996 TL	2000
TM-I 20 MM BL	Mavi	RIBBON MM 80/360 SW	2005950000	1,04 TL	2000
TM-I 20 MM GE	Sarı	RIBBON MM 80/360 SW	2005640000	1,04 TL	2000
TM-I 20 MM RT	Kırmızı	RIBBON MM 80/360 SW	2005820000	1,04 TL	2000
TM-I 20 MM WS	Beyaz	RIBBON MM 80/360 SW	2005490000	1,04 TL	2000
TM-I 23 MM BL	Mavi	RIBBON MM 80/360 SW	2005970000	1,08 TL	2000
TM-I 23 MM GE	Sarı	RIBBON MM 80/360 SW	2005670000	1,08 TL	2000
TM-I 23 MM RT	Kırmızı	RIBBON MM 80/360 SW	2005850000	1,08 TL	2000
TM-I 23 MM WS	Beyaz	RIBBON MM 80/360 SW	2005510000	1,08 TL	2000
TM-I 30 MM BL	Mavi	RIBBON MM 80/360 SW	2005990000	1,23 TL	2000
TM-I 30 MM GE	Sarı	RIBBON MM 80/360 SW	2005700000	1,23 TL	2000
TM-I 30 MM RT	Kırmızı	RIBBON MM 80/360 SW	2005870000	1,23 TL	2000
TM-I 30 MM WS	Beyaz	RIBBON MM 80/360 SW	2005530000	1,23 TL	2000

## Kablo Markalama WM

WM 0/12 1.0-2.0 MM GE	Sarı - 0.5 - 0.75 mm <sup>2</sup>	RIBBON MM 80/360 SW	2006250000	1,01 TL	2000
WM 0/12 1.0-2.0 MM WS	Beyaz - 0.5 - 0.75 mm <sup>2</sup>	RIBBON MM 80/360 SW	2006170000	1,01 TL	2000
WM 0/21 1.0-2.0 MM GE	Sarı - 0.5 - 0.75 mm <sup>2</sup>	RIBBON MM 80/360 SW	2006090000	1,11 TL	2000
WM 0/21 1.0-2.0 MM WS	Beyaz - 0.5 - 0.75 mm <sup>2</sup>	RIBBON MM 80/360 SW	2006010000	1,11 TL	2000
WM 0/6 1.0-2.0 MM GE	Sarı - 0.5 - 0.75 mm <sup>2</sup>	RIBBON MM 80/360 SW	2006410000	1,01 TL	2000
WM 0/6 1.0-2.0 MM WS	Beyaz - 0.5 - 0.75 mm <sup>2</sup>	RIBBON MM 80/360 SW	2006330000	1,01 TL	2000
WM 1/12 2.0-3.5 MM GE	Sarı - 0.75 - 2.5 mm <sup>2</sup>	RIBBON MM 80/360 SW	2006270000	1,11 TL	2000
WM 1/12 2.0-3.5 MM WS	Beyaz - 0.75 - 2.5 mm <sup>2</sup>	RIBBON MM 80/360 SW	2006190000	1,11 TL	2000
WM 1/21 2.0-3.5 MM GE	Sarı - 0.75 - 2.5 mm <sup>2</sup>	RIBBON MM 80/360 SW	2006110000	1,11 TL	2000
WM 1/21 2.0-3.5 MM WS	Beyaz - 0.75 - 2.5 mm <sup>2</sup>	RIBBON MM 80/360 SW	2006030000	1,11 TL	2000
WM 1/6 2.0-3.5 MM GE	Sarı - 0.75 - 2.5 mm <sup>2</sup>	RIBBON MM 80/360 SW	2006430000	1,01 TL	2000
WM 1/6 2.0-3.5 MM WS	Beyaz - 0.75 - 2.5 mm <sup>2</sup>	RIBBON MM 80/360 SW	2006350000	1,01 TL	2000
WM 2/12 3.5-5.0 MM GE	Sarı - 2.5 - 4.0 mm <sup>2</sup>	RIBBON MM 80/360 SW	2006290000	1,34 TL	2000
WM 2/12 3.5-5.0 MM WS	Beyaz - 2.5 - 4.0 mm <sup>2</sup>	RIBBON MM 80/360 SW	2006210000	1,34 TL	2000
WM 2/21 3.5-5.0 MM GE	Sarı - 2.5 - 4.0 mm <sup>2</sup>	RIBBON MM 80/360 SW	2006130000	1,40 TL	2000
WM 2/21 3.5-5.0 MM WS	Beyaz - 2.5 - 4.0 mm <sup>2</sup>	RIBBON MM 80/360 SW	2006050000	1,40 TL	2000
WM 2/6 3.5-5.0 MM GE	Sarı - 2.5 - 4.0 mm <sup>2</sup>	RIBBON MM 80/360 SW	2006450000	1,12 TL	2000
WM 2/6 3.5-5.0 MM WS	Beyaz - 2.5 - 4.0 mm <sup>2</sup>	RIBBON MM 80/360 SW	2006370000	1,12 TL	2000
WM 3/12 5.0-8.0 MM GE	Sarı - 4.0 - 16 mm <sup>2</sup>	RIBBON MM 80/360 SW	2006310000	1,57 TL	2000
WM 3/12 5.0-8.0 MM WS	Beyaz - 4.0 - 16 mm <sup>2</sup>	RIBBON MM 80/360 SW	2006230000	1,57 TL	2000
WM 3/21 5.0-8.0 MM GE	Sarı - 4.0 - 16 mm <sup>2</sup>	RIBBON MM 80/360 SW	2006150000	1,90 TL	2000

Serinin devamı sayfa 44



SFX 9/24 MM GE



ELS 6/30 MM GE



ESG 6/17 MM GE



ESG 6/17 MM SW



ESG 8/20 MM GR



SM 27/12.5 MM GN

Tip	Renk	Birlikte Kullanılacak Ribon	Sipariş No	Fiyat/Birim	Ambalaj
WM 3/21 5.0-8.0 MM WS	Beyaz - 4.0 - 16 mm <sup>2</sup>	RIBBON MM 80/360 SW	2006070000	1,90 TL	2000
WM 3/6 5.0-8.0 MM GE	Sarı - 4.0 - 16 mm <sup>2</sup>	RIBBON MM 80/360 SW	2006470000	1,34 TL	2000
WM 3/6 5.0-8.0 MM WS	Beyaz - 4.0 - 16 mm <sup>2</sup>	RIBBON MM 80/360 SW	2006390000	1,34 TL	2000
<b>Kablo Markalama SFX</b>					
SFX 9/24 MM GE	Sarı	RIBBON MM 80/360 SW	2005380000	3,14 TL	1000
SFX 9/24 MM WS	Beyaz	RIBBON MM 80/360 SW	2005320000	3,14 TL	1000
SFX 11/60 MM GE	Sarı	RIBBON MM 80/360 SW	2005400000	3,76 TL	1000
SFX 11/60 MM WS	Beyaz	RIBBON MM 80/360 SW	2005340000	3,76 TL	1000
SFX 30/60 MM GE	Sarı	RIBBON MM 80/360 SW	2005420000	6,05 TL	300
SFX 30/60 MM WS	Beyaz	RIBBON MM 80/360 SW	2005360000	6,05 TL	300
<b>Kablo Markalama ELS Taşıyıcı Kılıf İçi Markalama Yüzeyleri</b>					
ELS 6/30 MM GE	Sarı	RIBBON MM 80/360 SW	2010620000	1,53 TL	3000
ELS 6/30 MM WS	Beyaz	RIBBON MM 80/360 SW	2009980000	1,53 TL	3000
ELS 8/20 MM GE	Sarı	RIBBON MM 80/360 SW	2005240000	1,32 TL	3000
ELS 8/20 MM WS	Beyaz	RIBBON MM 80/360 SW	2005180000	1,32 TL	3000
ELS 16/40 MM GE	Sarı	RIBBON MM 80/360 SW	2005260000	2,03 TL	2000
ELS 16/40 MM WS	Beyaz	RIBBON MM 80/360 SW	2005200000	2,03 TL	2000
<b>Cihaz Markalama ESG, SM</b>					
ESG 6/17 MM GE	Sarı	RIBBON MM 80/360 SW	2005110000	1,46 TL	3000
ESG 6/17 MM GR	Gri	RIBBON MM 80/360 SW	2005120000	1,46 TL	3000
ESG 6/17 MM SW	Siyah	RIBBON MM 80/300 WS	2005130000	1,46 TL	3000
ESG 6/17 MM WS	Beyaz	RIBBON MM 80/360 SW	2005100000	1,46 TL	3000
ESG 8/20 MM GE	Sarı	RIBBON MM 80/360 SW	2005150000	1,37 TL	3000
ESG 8/20 MM GR	Gri	RIBBON MM 80/360 SW	2005160000	1,37 TL	3000
ESG 8/20 MM SW	Siyah	RIBBON MM 80/300 WS	2005170000	1,37 TL	3000
ESG 8/20 MM WS	Beyaz	RIBBON MM 80/360 SW	2005140000	1,37 TL	3000
ESG 9/17 MM GE	Sarı	RIBBON MM 80/360 SW	2005210000	1,74 TL	3000
ESG 9/17 MM GR	Gri	RIBBON MM 80/360 SW	2005230000	1,74 TL	3000
ESG 9/17 MM SW	Siyah	RIBBON MM 80/300 WS	2005250000	1,74 TL	3000
ESG 9/17 MM WS	Beyaz	RIBBON MM 80/360 SW	2005190000	1,74 TL	3000
SM 18/9.5 MM GE	Sarı	RIBBON MM 80/360 SW	2006240000	4,03 TL	1000
SM 18/9.5 MM GR	Gri	RIBBON MM 80/360 SW	2006260000	4,03 TL	1000
SM 18/9.5 MM SW	Siyah	RIBBON MM 80/300 WS	2006200000	4,03 TL	1000
SM 18/9.5 MM WS	Beyaz	RIBBON MM 80/360 SW	2006220000	4,03 TL	1000
SM 27/8 MM GE	Sarı	RIBBON MM 80/360 SW	2006420000	3,02 TL	1000
SM 27/8 MM GN	Yeşil	RIBBON MM 80/360 SW	2006490000	3,02 TL	1000
SM 27/8 MM GR	Gri	RIBBON MM 80/360 SW	2006480000	3,02 TL	1000
SM 27/8 MM RT	Kırmızı	RIBBON MM 80/360 SW	2006460000	3,02 TL	1000
SM 27/8 MM SW	Siyah	RIBBON MM 80/300 WS	2006440000	3,02 TL	1000
SM 27/8 MM WS	Beyaz	RIBBON MM 80/360 SW	2006400000	3,02 TL	1000
SM 27/12.5 MM GE	Sarı	RIBBON MM 80/360 SW	2006510000	3,70 TL	1000
SM 27/12.5 MM GN	Yeşil	RIBBON MM 80/360 SW	2006550000	3,70 TL	1000
SM 27/12.5 MM GR	Gri	RIBBON MM 80/360 SW	2006520000	3,70 TL	1000
SM 27/12.5 MM RT	Kırmızı	RIBBON MM 80/360 SW	2006540000	3,70 TL	1000
SM 27/12.5 MM SW	Siyah	RIBBON MM 80/300 WS	2006530000	3,70 TL	1000
SM 27/12.5 MM WS	Beyaz	RIBBON MM 80/360 SW	2006500000	3,70 TL	1000
SM 27/18 MM GE	Sarı	RIBBON MM 80/360 SW	2006300000	4,70 TL	1000
SM 27/18 MM GN	Yeşil	RIBBON MM 80/360 SW	2006380000	4,70 TL	1000
SM 27/18 MM GR	Gri	RIBBON MM 80/360 SW	2006340000	4,70 TL	1000
SM 27/18 MM RT	Kırmızı	RIBBON MM 80/360 SW	2006360000	4,70 TL	1000
SM 27/18 MM SW	Siyah	RIBBON MM 80/300 WS	2006320000	4,70 TL	1000

Serinin devamı sayfa 45



SM 27/18-22 MM RT



SM 36/18-30 MM GR



CC 15/27 MM WS



EL 12 MM GE 30M

Tip	Renk	Birlikte Kullanılacak Ribon	Sipariş No	Fiyat/Birim	Ambalaj
SM 27/18 MM WS	Beyaz	RIBBON MM 80/360 SW	2006280000	4,70 TL	1000
SM 27/18-22 MM GE	Sarı	RIBBON MM 80/360 SW	2005810000	7,50 TL	1000
SM 27/18-22 MM GN	Yeşil	RIBBON MM 80/360 SW	2005920000	7,32 TL	1000
SM 27/18-22 MM GR	Gri	RIBBON MM 80/360 SW	2005860000	7,50 TL	1000
SM 27/18-22 MM RT	Kırmızı	RIBBON MM 80/360 SW	2005900000	7,32 TL	1000
SM 27/18-22 MM SW	Siyah	RIBBON MM 80/300 WS	2005880000	7,32 TL	1000
SM 27/18-22 MM WS	Beyaz	RIBBON MM 80/360 SW	2005840000	7,50 TL	1000
SM 36/18-30 MM GE	Sarı	RIBBON MM 80/360 SW	2006080000	8,06 TL	1000
SM 36/18-30 MM GN	Yeşil	RIBBON MM 80/360 SW	2006180000	8,06 TL	1000

## Cihaz Markalama SM, CC, EL

SM 36/18-30 MM GR	Gri	RIBBON MM 80/360 SW	2006120000	8,06 TL	1000
SM 36/18-30 MM RT	Kırmızı	RIBBON MM 80/360 SW	2006160000	8,06 TL	1000
SM 36/18-30 MM SW	Siyah	RIBBON MM 80/300 WS	2006140000	8,06 TL	1000
SM 36/18-30 MM WS	Beyaz	RIBBON MM 80/360 SW	2006100000	8,06 TL	1000
SM DIA 60-22 MM GE	Sarı	RIBBON MM 80/360 SW	2006060000	11,00 TL	450
CC 15/27 MM GE	Sarı	RIBBON MM 80/360 SW	2005630000	1,79 TL	450
CC 15/27 MM GR	Gri	RIBBON MM 80/360 SW	2005660000	1,79 TL	450
CC 15/27 MM SW	Siyah	RIBBON MM 80/300 WS	2005690000	1,79 TL	450
CC 15/27 MM WS	Beyaz	RIBBON MM 80/360 SW	2005600000	1,79 TL	450
CC 15/45 MM GE	Sarı	RIBBON MM 80/360 SW	2005520000	2,69 TL	450
CC 15/45 MM GR	Gri	RIBBON MM 80/360 SW	2005540000	2,69 TL	450
CC 15/45 MM SW	Siyah	RIBBON MM 80/300 WS	2005570000	2,69 TL	450
CC 15/45 MM WS	Beyaz	RIBBON MM 80/360 SW	2005500000	2,69 TL	450
CC 15/60 MM GE	Sarı	RIBBON MM 80/360 SW	2005430000	3,16 TL	450
CC 15/60 MM GR	Gri	RIBBON MM 80/360 SW	2005460000	3,16 TL	450
CC 15/60 MM SW	Siyah	RIBBON MM 80/300 WS	2005480000	3,16 TL	450
CC 15/60 MM WS	Beyaz	RIBBON MM 80/360 SW	2005410000	3,16 TL	450
CC 30/60 MM GE	Sarı	RIBBON MM 80/360 SW	2005350000	7,28 TL	450
CC 30/60 MM GR	Gri	RIBBON MM 80/360 SW	2005370000	7,28 TL	450
CC 30/60 MM SW	Siyah	RIBBON MM 80/300 WS	2005390000	7,28 TL	450
CC 30/60 MM WS	Beyaz	RIBBON MM 80/360 SW	2005330000	7,28 TL	450
CC 85/54 MM GE	Sarı	RIBBON MM 80/360 SW	2005280000	19,05 TL	450
CC 85/54 MM GR	Gri	RIBBON MM 80/360 SW	2005290000	19,05 TL	450
CC 85/54 MM SW	Siyah	RIBBON MM 80/300 WS	2005310000	19,05 TL	450
CC 85/54 MM WS	Beyaz	RIBBON MM 80/360 SW	2005270000	19,05 TL	450
EL 12 MM GE 30M	Sarı	RIBBON MM 80/360 SW	2006580000	538,00 TL	1
EL 12 MM WS 30M	Beyaz	RIBBON MM 80/360 SW	2006570000	538,00 TL	1
EL 15 MM GE 30M	Sarı	RIBBON MM 80/360 SW	2006600000	661,00 TL	1
EL 15 MM SI 30M	Gümüş	RIBBON MM 80/360 SW	2006610000	661,00 TL	1
EL 15 MM WS 30M	Beyaz	RIBBON MM 80/360 SW	2006590000	661,00 TL	1
EL 27 MM GE 30M	Sarı	RIBBON MM 80/360 SW	2006640000	1.232,00 TL	1
EL 27 MM SI 30M	Gümüş	RIBBON MM 80/360 SW	2006620000	1.232,00 TL	1
EL 27 MM WS 30M	Beyaz	RIBBON MM 80/360 SW	2006630000	1.232,00 TL	1
EL 38 MM GE 30M	Sarı	RIBBON MM 80/360 SW	2006670000	1.680,00 TL	1
EL 38 MM SI 30M	Gümüş	RIBBON MM 80/360 SW	2006650000	1.680,00 TL	1
EL 38 MM WS 30M	Beyaz	RIBBON MM 80/360 SW	2006660000	1.680,00 TL	1
EL 60 MM GE 30M	Sarı	RIBBON MM 80/360 SW	2006700000	2.574,00 TL	1
EL 60 MM SI 30M	Gümüş	RIBBON MM 80/360 SW	2006680000	2.574,00 TL	1
EL 60 MM WS 30M	Beyaz	RIBBON MM 80/360 SW	2006690000	2.574,00 TL	1
EL 100 MM GE 30M	Sarı	RIBBON MM 110/360 SW	2006730000	4.368,00 TL	1
EL 100 MM SI 30M	Gümüş	RIBBON MM 110/360 SW	2006710000	4.368,00 TL	1

Serinin devamı sayfa 46





WKM 18/43



HSS-HF 1.2-2.4 EL Y13M



HSS-HF 12.7-25.4 EL W10M



LM MT300 15/6 WS

Tip	Renk	Birlikte Kullanılacak Ribon	Sipariş No	Fiyat/Birim	Ambalaj
EL 100 MM WS 30M	Beyaz	RIBBON MM 110/360 SW	2006720000	4.292,00 TL	1

**Not:** Markalamalar ile kullanılacak ribonlar "Cihaz Aksesuarları" başlığı altından haricen sipariş edilmelidir

Tip	Açıklama	En / Boy	Sipariş No	Fiyat/Birim	Ambalaj
<b>Kablo Markalama Yüzeyleri</b>					
WKM 18/43	Kablo markalama	18 / 43 mm	1610700000	11,80 TL	50
WKM 8/20	Kablo markalama	8 / 20 mm	1753490000	11,20 TL	50
WKM 8/30	Kablo markalama	8 / 30 mm	1631910000	11,20 TL	50

Tip	Açıklama	Ölçü / Renk	Sipariş No	Fiyat/Birim	Ambalaj
<b>Kablo Markalama Yüzeyleri</b>					
ESO 5 DIN A4 WS	Beyaz, Tabaka/60	40 x 16,5 mm / Beyaz	1607710000	31,60 TL	10
ESO 7 DIN A4 WS	Beyaz, Tabaka/60	27 x 6,3 mm /Beyaz	1607720000	31,60 TL	10

Tip	Kesit	Ölçü	Sipariş No	Fiyat/Birim	Ambalaj
<b>HSS Daralan Makoron - Şerit Tipi</b>					
HSS-HF 1.2-2.4 EL Y13M	0.25 - 0.5 mm <sup>2</sup> kablo çapı	13 Metre	1423220000	584,00 TL	1
HSS-HF 1.6-3.2 EL Y13M	0.5 - 1.5 mm <sup>2</sup> kablo çapı	13 Metre	1423230000	619,00 TL	1
HSS-HF 2.4-4.8 EL Y13M	0.75 - 4 mm <sup>2</sup> kablo çapı	13 Metre	1423240000	724,00 TL	1
HSS-HF 3.2-6.4 EL Y13M	1.5 - 6 mm <sup>2</sup> kablo çapı	13 Metre	1423250000	871,00 TL	1
HSS-HF 4.8-9.5 EL Y13M	4.00 - 16 mm <sup>2</sup> kablo çapı	13 Metre	1423260000	1.195,00 TL	1
HSS-HF 6.4-12.7 EL Y13M	6 - 35 mm <sup>2</sup> kablo çapı	13 Metre	1423270000	1.376,00 TL	1
HSS-HF 9.5-19.1 EL Y10M	16 - 70 mm <sup>2</sup> kablo çapı	10 Metre	1423280000	1.508,00 TL	1
HSS-HF 12.7-25.4 EL Y10M	35 - 120 mm <sup>2</sup> kablo çapı	10 Metre	1423290000	2.131,00 TL	1
HSS-HF 1.2-2.4 EL W13M	0.25 - 0.5 mm <sup>2</sup> kablo çapı	13 Metre	1423330000	580,00 TL	1
HSS-HF 1.6-3.2 EL W13M	0.5 - 1.5 mm <sup>2</sup> kablo çapı	13 Metre	1423340000	619,00 TL	1
HSS-HF 2.4-4.8 EL W13M	0.75 - 4 mm <sup>2</sup> kablo çapı	13 Metre	1423350000	724,00 TL	1
HSS-HF 3.2-6.4 EL W13M	1.5 - 6 mm <sup>2</sup> kablo çapı	13 Metre	1423360000	871,00 TL	1
HSS-HF 4.8-9.5 EL W13M	4.00 - 16 mm <sup>2</sup> kablo çapı	13 Metre	1423370000	1.195,00 TL	1
HSS-HF 6.4-12.7 EL W13M	6 - 35 mm <sup>2</sup> kablo çapı	13 Metre	1423380000	1.376,00 TL	1
HSS-HF 9.5-19.1 EL W10M	16 - 70 mm <sup>2</sup> kablo çapı	13 Metre	1423390000	1.508,00 TL	1
HSS-HF 12.7-25.4 EL W10M	35 - 120 mm <sup>2</sup> kablo çapı	10 Metre	1423410000	2.131,00 TL	1
HSS-HF 1.2-2.4 EL Y30M	0.25 - 0.5 mm <sup>2</sup> kablo çapı	10 Metre	1513140000	1.254,00 TL	1
HSS-HF 1.6-3.2 EL Y30M	0.5 - 1.5 mm <sup>2</sup> kablo çapı	30 Metre	1513150000	1.331,00 TL	1
HSS-HF 2.4-4.8 EL Y30M	0.75 - 4 mm <sup>2</sup> kablo çapı	30 Metre	1513170000	1.546,00 TL	1
HSS-HF 3.2-6.4 EL Y30M	1.5 - 6 mm <sup>2</sup> kablo çapı	30 Metre	1513180000	1.877,00 TL	1
HSS-HF 4.8-9.5 EL Y30M	4.00 - 16 mm <sup>2</sup> kablo çapı	30 Metre	1513190000	2.565,00 TL	1
HSS-HF 6.4-12.7 EL Y30M	6 - 35 mm <sup>2</sup> kablo çapı	30 Metre	1513200000	2.948,00 TL	1
HSS-HF 9.5-19.1 EL Y30M	16 - 70 mm <sup>2</sup> kablo çapı	30 Metre	1513220000	4.193,00 TL	1
HSS-HF 12.7-25.4 EL Y30M	35 - 120 mm <sup>2</sup> kablo çapı	30 Metre	1513230000	5.940,00 TL	1
HSS-HF 1.2-2.4 EL W30M	0.25 - 0.5 mm <sup>2</sup> kablo çapı	30 Metre	1513240000	1.254,00 TL	1
HSS-HF 1.6-3.2 EL W30M	0.5 - 1.5 mm <sup>2</sup> kablo çapı	30 Metre	1513250000	1.331,00 TL	1
HSS-HF 2.4-4.8 EL W30M	0.75 - 4 mm <sup>2</sup> kablo çapı	30 Metre	1513270000	1.546,00 TL	1
HSS-HF 3.2-6.4 EL W30M	1.5 - 6 mm <sup>2</sup> kablo çapı	30 Metre	1513280000	1.877,00 TL	1
HSS-HF 4.8-9.5 EL W30M	4.00 - 16 mm <sup>2</sup> kablo çapı	30 Metre	1513290000	2.565,00 TL	1
HSS-HF 6.4-12.7 EL W30M	6 - 35 mm <sup>2</sup> kablo çapı	30 Metre	1513300000	2.948,00 TL	1
HSS-HF 9.5-19.1 EL W30M	16 - 70 mm <sup>2</sup> kablo çapı	30 Metre	1513320000	4.193,00 TL	1
HSS-HF 12.7-25.4 EL W30M	35 - 120 mm <sup>2</sup> kablo çapı	30 Metre	1513330000	5.940,00 TL	1

**Not:** 30m'lik Isıyla Daralan Makaronlar İçin Taşıyıcı Aparat Kullanılması Önerilir.

Tip	Renk	Ölçü / Adet	Sipariş No	Fiyat/Birim	Ambalaj
<b>Cihaz Etiketleri</b>					
LM MT300 15/6 WS	Beyaz	15,2x6 mm / 484 Adet	1686361044	148,60 TL	10
LM MT300 15/6 GE	Sarı	15,2x6 mm / 484 Adet	1686361687	148,60 TL	10

Serinin devamı sayfa 47

Tip	Renk	Ölçü / Adet	Sipariş No	Fiyat/Birim	Ambalaj
LM MT300 15/6 SI	Gümüş	15,2x6 mm / 484 Adet	1686360001	148,60 TL	10
LM MT300 17/9 WS	Beyaz	17,8x9 mm / 341 Adet	1724151044	148,60 TL	10
LM MT300 17/9 GE	Sarı	17,8x9 mm / 341 Adet	1724151687	148,60 TL	10
LM MT300 17/9 SI	Gümüş	17,8x9 mm / 341 Adet	1724150001	148,60 TL	10
LM MT300 20/8 WS	Beyaz	20,3x8 mm / 264 Adet	1686381044	148,60 TL	10
LM MT300 20/8 GE	Sarı	20,3x8 mm / 264 Adet	1686381687	148,60 TL	10
LM MT300 20/8 SI	Gümüş	20,3x8 mm / 264 Adet	1686380001	148,60 TL	10
LM MT300 26/10 WS	Beyaz	26,0x10 mm / 156 Adet	1686401044	148,60 TL	10
LM MT300 26/10 GE	Sarı	26,0x10 mm / 156 Adet	1686401687	148,60 TL	10
LM MT300 26/10 SI	Gümüş	26,0x10 mm / 156 Adet	1686400001	148,60 TL	10
LM MT300 56/22 WS	Beyaz	56,0x22 mm / 36 Adet	1686421044	148,60 TL	10
LM MT300 56/22 GE	Sarı	56,0x22 mm / 36 Adet	1686421687	148,60 TL	10
LM MT300 56/22 SI	Gümüş	56,0x22 mm / 36 Adet	1686420001	148,60 TL	10

Tip	Renk	Tabaka/Adet	Sipariş No	Fiyat/Birim	Ambalaj
<b>Cihaz Etiketleri (Tekstil Tip Örmeye Yüzeyler)</b>					
TABPACK 14X9	Sarı	Sayfa başına 840 adet	1686110000	416,55 TL	1
TABPACK 15X6	Sarı	Sayfa başına 1000 adet	1686120000	420,65 TL	1
TABPACK 19X11 M. RAND	Sarı	Sayfa başına 440 adet	1686130000	420,65 TL	1
TABPACK 21X8	Sarı	Sayfa başına 640 adet	1686140000	420,65 TL	1
TABPACK 38X11 M. RAND	Sarı	Sayfa başı 22 adet	1686150000	417,75 TL	1
PAGETAB 15/9	Sarı A4 Formatı	Sayfa başı 310 adet	1686160000	127,70 TL	25
PAGETAB 19/11	Sarı A4 Formatı	Sayfa başı 200 adet	1686170000	127,70 TL	25
PAGETAB 20/8	Sarı A4 Formatı	Sayfa başı 280 adet	1686180000	129,00 TL	25
PAGETAB 28/11	Sarı A4 Formatı	Sayfa başı 125 adet	1686190000	129,00 TL	25
PAGETAB 38/11	Sarı A4 Formatı	Sayfa başı 100 adet	1686200000	129,00 TL	25
PAGETAB 56/22	Sarı A4 Formatı	Sayfa başı 24 adet	1686210000	126,20 TL	25

Tip	Çap	Ölçü / Renk / Adet	Sipariş No	Fiyat/Birim	Ambalaj
<b>WriteOn - Kablo ve İletken Markalaması</b>					
LM WO 15/70 WS	8,2 - 14,3 mm	15 x 30 mm / Beyaz / 30 Adet	1759871044	244,90 TL	10
LM WO 15/140 WS	16,2 - 36,4 mm	15 x 70 mm / Beyaz / 26 Adet	1773880000	192,15 TL	10
LM WO 18/34 WS	5,0 - 7,0 mm	18 x 12,7 mm / Beyaz / 88 Adet	1695711044	178,15 TL	10
LM WO 18/34 GE	5,0 - 7,0 mm	18 x 12,7 mm / Sarı / 88 Adet	1695711687	178,15 TL	10
LM WO 23/55 WS	6,8 - 12,0 mm	23 x 12,7 mm / Beyaz / 40 Adet	1695721044	224,55 TL	10
LM WO 23/55 GE	6,8 - 12,0 mm	23 x 12,7 mm / Sarı / 40 Adet	1695721687	224,55 TL	10
LM WO 25/68 WS	8,2 - 14,3 mm	25 x 17 mm / Beyaz / 28 Adet	1695731044	178,15 TL	10
LM WO 25/68 GE	8,2 - 14,3 mm	25 x 17 mm / Sarı / 28 Adet	1695731687	178,15 TL	10
LM WO 25/140 WS	16,2 x 36,4 mm	25 x 26 mm / Beyaz / 16 Adet	1712491044	178,15 TL	10
LM WO 25/140 GE	16,2 x 36,4 mm	25 x 26 mm / Sarı / 16 Adet	1712491687	178,15 TL	10
LM WO 36/93 WS	9,5 - 22,3 mm	36 x 25 mm / Beyaz / 15 Adet	1695741044	224,55 TL	10
LM WO 36/93 GE	9,5 - 22,3 mm	36 x 25 mm / Sarı / 15 Adet	1695741687	224,55 TL	10



TABPACK 14X9



LM WO 15/70 WS

## PCB - Baskılı Devre Klemensleri

Tip	V / A	Açıklama	Sipariş No	Fiyat/Birim	Ambalaj
<b>OMNIMATE Baskılı Devre Fiş/Soket Konnektörleri: SL/BL Sistemi. Pin Aralığı: 3,50 mm</b>					
<b>Yatay Fiş</b>					
SL 3.50/02/90 3.2SN OR BX	250 / 17	2 Kutup	1597210000	4,64 TL	100
SL 3.50/03/90 3.2SN OR BX	250 / 17	3 Kutup	1597220000	7,46 TL	100
SL 3.50/04/90 3.2SN OR BX	250 / 17	4 Kutup	1597230000	9,34 TL	100
SL 3.50/05/90 3.2SN OR BX	250 / 17	5Kutup	1597240000	12,15 TL	50
SL 3.50/06/90 3.2SN OR BX	250 / 17	6 Kutup	1597250000	14,55 TL	50
SL 3.50/07/90 3.2SN OR BX	250 / 17	7 Kutup	1597260000	16,50 TL	50
SL 3.50/08/90 3.2SN OR BX	250 / 17	8 Kutup	1597270000	19,45 TL	50
SL 3.50/09/90 3.2SN OR BX	250 / 17	9 Kutup	1597280000	21,50 TL	50
SL 3.50/10/90 3.2SN OR BX	250 / 17	10 Kutup	1597290000	24,45 TL	50
SL 3.50/11/90 3.2SN OR BX	250 / 17	11 Kutup	1597300000	26,60 TL	50
SL 3.50/12/90 3.2SN OR BX	250 / 17	12 Kutup	1597310000	28,80 TL	50
<b>Dikey Fiş</b>					
SL 3.50/02/180 3.2SN OR BX	250 / 17	2 Kutup	1604770000	4,64 TL	100
SL 3.50/03/180 3.2SN OR BX	250 / 17	3 Kutup	1604780000	7,46 TL	100
SL 3.50/04/180 3.2SN OR BX	250 / 17	4 Kutup	1604790000	9,34 TL	100
SL 3.50/05/180 3.2SN OR BX	250 / 17	5Kutup	1604800000	12,15 TL	50
SL 3.50/06/180 3.2SN OR BX	250 / 17	6 Kutup	1604810000	14,55 TL	50
SL 3.50/07/180 3.2SN OR BX	250 / 17	7 Kutup	1604820000	16,50 TL	50
SL 3.50/08/180 3.2SN OR BX	250 / 17	8 Kutup	1604830000	19,45 TL	50
SL 3.50/09/180 3.2SN OR BX	250 / 17	9 Kutup	1604840000	21,50 TL	50
SL 3.50/10/180 3.2SN OR BX	250 / 17	10 Kutup	1604850000	24,45 TL	50
SL 3.50/11/180 3.2SN OR BX	250 / 17	11 Kutup	1604860000	26,60 TL	50
SL 3.50/12/180 3.2SN OR BX	250 / 17	12 Kutup	1604870000	28,80 TL	50
<b>Soket</b>					
BL 3.50/02/180 SN OR BX	250 / 12	2 Kutup	1597360000	12,70 TL	264
BL 3.50/03/180 SN OR BX	250 / 12	3 Kutup	1597370000	19,45 TL	174
BL 3.50/04/180 SN OR BX	250 / 12	4 Kutup	1597380000	25,10 TL	132
BL 3.50/05/180 SN OR BX	250 / 12	5Kutup	1597390000	32,50 TL	102
BL 3.50/06/180 SN OR BX	250 / 12	6 Kutup	1597400000	38,90 TL	84
BL 3.50/07/180 SN OR BX	250 / 12	7 Kutup	1597410000	45,30 TL	72
BL 3.50/08/180 SN OR BX	250 / 12	8 Kutup	1597420000	51,05 TL	66
BL 3.50/09/180 SN OR BX	250 / 12	9 Kutup	1597430000	57,50 TL	54
BL 3.50/10/180 SN OR BX	250 / 12	10 Kutup	1597440000	63,95 TL	48
BL 3.50/11/180 SN OR BX	250 / 12	11 Kutup	1597450000	71,25 TL	48
BL 3.50/12/180 SN OR BX	250 / 12	12 Kutup	1597460000	77,60 TL	42
<b>OMNIMATE Baskılı Devre Fiş/Soket Konnektörleri: SL/BL Sistemi. Pin Aralığı: 5,08 mm</b>					
<b>Yatay Soket (Vidalı Bağlantı)</b>					
BLZP 5.08HC/02/180 SN OR BX	400 / 19	2 Kutup	1943580000	11,50 TL	180
BLZP 5.08HC/03/180 SN OR BX	400 / 19	3 Kutup	1943590000	17,20 TL	120
BLZP 5.08HC/04/180 SN OR BX	400 / 19	4 Kutup	1943600000	23,05 TL	90
BLZP 5.08HC/05/180 SN OR BX	400 / 19	5Kutup	1943610000	28,80 TL	72
BLZP 5.08HC/06/180 SN OR BX	400 / 19	6 Kutup	1943620000	34,55 TL	60
BLZP 5.08HC/07/180 SN OR BX	400 / 19	7 Kutup	1943630000	43,90 TL	48
BLZP 5.08HC/08/180 SN OR BX	400 / 19	8 Kutup	1943640000	46,15 TL	42
BLZP 5.08HC/09/180 SN OR BX	400 / 19	9 Kutup	1943650000	56,05 TL	36
BLZP 5.08HC/10/180 SN OR BX	400 / 19	10 Kutup	1943660000	61,80 TL	36
BLZP 5.08HC/11/180 SN OR BX	400 / 19	11 Kutup	1943670000	68,25 TL	30
BLZP 5.08HC/12/180 SN OR BX	400 / 19	12 Kutup	1943680000	74,85 TL	30

SL 3.50/02/90 3.2SN OR BX



SL 3.50/02/180 3.2SN OR BX



BL 3.50/02/180 SN OR BX



BLZP 5.08HC/02/180 SN OR BX





SL 5.08HC/05/180 SN OR BX



SL 5.08HC/12/180 SN OR BX



SLA 02/90 3.2SN OR BX



SLA 02/180 3.2SN OR BX



SLAD 04/90 3.2SN OR



BLA 2 SN OR

Tip	V / A	Açıklama	Sipariş No	Fiyat/Birim	Ambalaj
<b>Dikey Fiş/5.08</b>					
* SL 5.08HC/02/180 SN OR BX	400 / 24	2 Kutup	1146320000	4,02 TL	100
* SL 5.08HC/03/180 SN OR BX	400 / 24	3 Kutup	1146340000	6,07 TL	100
* SL 5.08HC/04/180 SN OR BX	400 / 24	4 Kutup	1146380000	8,09 TL	100
* SL 5.08HC/05/180 SN OR BX	400 / 24	5Kutup	1146410000	9,87 TL	50
* SL 5.08HC/06/180 SN OR BX	400 / 24	6 Kutup	1146450000	11,85 TL	50
* SL 5.08HC/07/180 SN OR BX	400 / 24	7 Kutup	1146470000	13,85 TL	50
* SL 5.08HC/08/180 SN OR BX	400 / 24	8 Kutup	1146490000	15,80 TL	50
* SL 5.08HC/09/180 SN OR BX	400 / 24	9 Kutup	1146510000	17,75 TL	50
* SL 5.08HC/10/180 SN OR BX	400 / 24	10 Kutup	1146530000	19,65 TL	50
* SL 5.08HC/11/180 SN OR BX	400 / 24	11 Kutup	1146550000	21,60 TL	50
* SL 5.08HC/12/180 SN OR BX	400 / 24	12 Kutup	1146570000	23,70 TL	50
<b>Yatay Fiş</b>					
SLA 02/90 3.2SN OR BX	400 / 17,5	2 Kutup	1238060000	5,24 TL	100
SLA 03/90 3.2SN OR BX	400 / 17,5	3 Kutup	1238160000	8,13 TL	100
SLA 04/90 3.2SN OR BX	400 / 17,5	4 Kutup	1238260000	11,20 TL	100
SLA 05/90 3.2SN OR BX	400 / 17,5	5Kutup	1238360000	13,45 TL	50
SLA 06/90 3.2SN OR BX	400 / 17,5	6 Kutup	1238460000	14,80 TL	50
SLA 07/90 3.2SN OR BX	400 / 17,5	7 Kutup	1238560000	16,50 TL	50
SLA 08/90 3.2SN OR BX	400 / 17,5	8 Kutup	1238660000	19,70 TL	50
SLA 09/90 3.2SN OR BX	400 / 17,5	9 Kutup	1238760000	23,50 TL	50
SLA 10/90 3.2SN OR BX	400 / 17,5	10 Kutup	1238860000	24,65 TL	50
SLA 11/90 3.2SN OR BX	400 / 17,5	11 Kutup	1238960000	29,10 TL	50
SLA 12/90 3.2SN OR BX	400 / 17,5	12 Kutup	1239060000	31,35 TL	50
<b>Dikey Fiş</b>					
SLA 02/180 3.2SN OR BX	400 / 17,5	2 Kutup	1239560000	4,03 TL	100
SLA 03/180 3.2SN OR BX	400 / 17,5	3 Kutup	1239660000	6,18 TL	100
SLA 04/180 3.2SN OR BX	400 / 17,5	4 Kutup	1239760000	9,86 TL	100
SLA 05/180 3.2SN OR BX	400 / 17,5	5Kutup	1239860000	12,75 TL	50
SLA 06/180 3.2SN OR BX	400 / 17,5	6 Kutup	1239960000	14,80 TL	50
SLA 07/180 3.2SN OR BX	400 / 17,5	7 Kutup	1240060000	16,50 TL	50
SLA 08/180 3.2SN OR BX	400 / 17,5	8 Kutup	1240160000	19,70 TL	50
SLA 09/180 3.2SN OR BX	400 / 17,5	9 Kutup	1240260000	24,65 TL	50
SLA 10/180 3.2SN OR BX	400 / 17,5	10 Kutup	1240360000	26,90 TL	50
SLA 11/180 3.2SN OR BX	400 / 17,5	11 Kutup	1240460000	29,10 TL	50
SLA 12/180 3.2SN OR BX	400 / 17,5	12 Kutup	1240560000	31,35 TL	50
<b>Yatay Fiş - İki Katlı</b>					
SLAD 04/90 3.2SN OR	400 / 10	4 Kutup	1320060000	20,15 TL	50
SLAD 06/90 3.2SN OR	400 / 10	6 Kutup	1320160000	29,10 TL	50
SLAD 08/90 3.2SN OR	400 / 10	8 Kutup	1372460000	39,20 TL	50
SLAD 12/06/90 3.2SN OR	400 / 10	12 Kutup	1372660000	54,90 TL	50
<b>Soket</b>					
BLA 2 SN OR	400 / 17,5	2 Kutup	1281760000	12,15 TL	180
BLA 3 SN OR	400 / 17,5	3 Kutup	1281860000	18,10 TL	120
BLA 4 SN OR	400 / 17,5	4 Kutup	1281960000	31,35 TL	90
BLA 5 SN OR	400 / 17,5	5Kutup	1282060000	33,15 TL	72
BLA 6 SN OR	400 / 17,5	6 Kutup	1282160000	47,05 TL	60
BLA 7 SN OR	400 / 17,5	7 Kutup	1282260000	54,90 TL	48
BLA 8 SN OR	400 / 17,5	8 Kutup	1282360000	62,70 TL	42
BLA 9 SN OR	400 / 17,5	9 Kutup	1282460000	60,20 TL	36
BLA 10 SN OR	400 / 17,5	10 Kutup	1282560000	78,40 TL	36

Serinin devamı sayfa 50

## PCB - Baskılı Devre Klemensleri



PS 3.50/02/90 3.5SN BK BX



LS 5.08/02/90 3.5SN BK BX



LPP 5.08/02/90 3.2SN OR BX



LSF-SMT 5.08/02/180 3.5SN BK TU

Tip	V / A	Açıklama	Sipariş No	Fiyat/Birim	Ambalaj
BLA 11 SN OR	400 / 17,5	11 Kutup	1282660000	78,30 TL	30
BLA 12 SN OR	400 / 17,5	12 Kutup	1282760000	82,75 TL	30
<b>PS Sistemi. Pin Aralığı: 3,50 mm - Pin Uzunluk 3,50 mm</b>					
PS 3.50/02/90 3.5SN BK BX	320 / 17,5	2 Kutup	1811180000	3,76 TL	100
PS 3.50/03/90 3.5SN BK BX	320 / 17,5	3 Kutup	1811190000	5,44 TL	100
<b>PM Sistemi. Pin Aralığı: 5,08 mm - Pin Uzunluk 3,50 mm</b>					
PM 5.08/02/90 3.5SN OR BX	600 / 24	2 Kutup	1760490000	2,64 TL	500
PM 5.08/03/90 3.5SN OR BX	600 / 24	3 Kutup	1760500000	3,83 TL	500
<b>LS Sistemi. Pin Aralığı: 5,08 mm - Pin Uzunluk 3,50 mm</b>					
LS 5.08/02/90 3.5SN BK BX	600 / 24	2 Kutup	1810850000	4,64 TL	100
LS 5.08/03/90 3.5SN BK BX	600 / 24	3 Kutup	1810860000	7,06 TL	100
<b>LM Sistemi. Pin Aralığı: 5,08 mm - Pin Uzunluk 3,50 mm</b>					
LM 5.08/02/90 3.5SN OR BX	600 / 17,5	2 Kutup	1716080000	4,97 TL	500
LM 5.08/03/90 3.5SN OR BX	600 / 17,5	3 Kutup	1716090000	7,46 TL	500
<b>LP Sistemi. Pin Aralığı: 5,08 mm - Pin Uzunluk 3,20 mm</b>					
LPP 5.08/02/90 3.2SN OR BX	500 / 32	2 Kutup	1594400000	9,34 TL	100
LPP 5.08/03/90 3.2SN OR BX	500 / 32	3 Kutup	1594410000	14,15 TL	100
<b>LSF Sistemi. Pin Aralığı: 5,08 mm - Pin Uzunluk 3,50 mm</b>					
LSF-SMT 5.08/02/90 3.5SN BK TU	500 / 17,5	2 Kutup	1824810000	5,44 TL	59
LSF-SMT 5.08/03/90 3.5SN BK TU	500 / 17,5	3 Kutup	1824820000	8,06 TL	38
<b>LSF Sistemi. Pin Aralığı: 5,08 mm - Pin Uzunluk 3,50 mm (THR Reflow Lehimleme)</b>					
LSF-SMT 5.08/02/180 3.5SN BK TU	500 / 17,5	2 Kutup	1826040000	5,44 TL	59
LSF-SMT 5.08/03/180 3.5SN BK TU	500 / 17,5	3 Kutup	1826060000	8,06 TL	38
<b>SMD Sistemi</b>					
LSF-SMD 3.50/02/180 SN BK RL	500 / 17,5	2 Kutup	1250360000	15,45 TL	235
LSF-SMD 3.50/03/180 SN BK RL	500 / 17,5	3 Kutup	1250370000	19,45 TL	180
Tip	Açıklama	Sipariş No	Fiyat/Birim	Ambalaj	
<b>Baskılı Devre Kartı, Raya Montaj Malzemeleri</b>					
HP SKH	SKH İçin Tutucu Bara	0137100000	2,50 €	20	
SKH SAEULE PBTP20GV OR	Baskılı Devre Kızağı	0550160000	6,00 €	10	
RH 1 F.SKH 31 S	Baskılı Devre Mandalı	0587160000	28,10 TL	20	
RH 2 F.SKH 32-48	Baskılı Devre Mandalı	0632760000	39,20 TL	20	
FM 4/TS35	TS 35 Ray Adaptörü	0687900000	11,50 TL	40	
MB M6/M4 GR	TS 32 Ray Adaptörü	0334900000	12,90 TL	20	
RF RS 70 RE/A4/O.BEZ OR	Sağ Ayak	0126260000	28,10 TL	20	
RF RS 70 LI/A2/O.SG OR	Sol Ayak	0119660000	24,45 TL	20	
RF RS 70 MI/A6 OR	Orta Ayak	0213760000	24,45 TL	20	
ZW 5 RS OR	5 mm'lik Profil	0119760000	24,45 TL	20	
ZW 15 RS OR	15 mm'lik Profil	0119860000	28,10 TL	20	
ZW 25 RS OR	25 mm'lik Profil	0126160000	28,10 TL	20	
ZW 30 RS OR	30 mm'lik Profil	0119960000	29,45 TL	20	
ZW 45 RS OR	45 mm'lik Profil	0120060000	31,00 TL	20	
PF RS 80 OR 2000MM	84 mm'lik Profil (2m)	4157440000	269,10 TL	2M	
RF 180 OR	Montaj Ayağı	1324460000	24,45 TL	20	
AP 80 OR	Nihayet Plakası	1324260000	21,50 TL	20	
PF RS 100 OR 2000MM A.1	Profil 104 mm (2m)	4144870000	338,15 TL	2M	
AP 100 OR	Nihayet Plakası	1185060000	28,10 TL	20	
<b>Baskılı Devre Kızağı (Komple)</b>					
SKH D32 LP 5/16 RH2	Baskılı Devre Kızağı	0586761001	70,00 €	1	
SKH 31 LP 250VAC RH1	Baskılı Devre Kızağı	0648661001	70,00 €	1	

## RockStar® - Sanayi Tipi Fiş - Soketlerde Yeni Boyut

Ağır çevre koşulları altında güvenli ve modüler bağlantı gerektiren, makina ve diğer elektrik bağlantılarında kullanılır. Çok dayanıklı alüminyum dökümden imal edilen kutular rutubet, kirli ortam ve mekanik darbe gibi çevresel koşullarda mükemmel bir koruma sağlar.

Özel modüler klemens kombinasyonları, enerji iletimini pnomatik ve data sinyalleri ile tek bir kutuda birleştirebilir.

Weidmüller patentli kilitleme mekanizması ile RockStar® ağır şartlar için ihtiyaç duyulan çok çeşitli bağlantıları içerir. Ürün yelpazemiz ile çeşitli uygulama ihtiyaçlarınıza tam olarak cevap vererek ürünlerinizin kalitesini üst seviyeye taşır.

Rockstar ihtiyacınıza uygun ürünü bulmanızı kolaylaştırarak zaman ve maliyet avantajı sağlar. Üretim şeklinizi optimumlaştırarak pazar pozisyonunuzu kuvvetlendirir. Böylece faaliyet gösterdiğiniz pazarda rakiplerinize karşı avantajlar sağlarsınız.

## RockStar® Sanayi Tipi Fiş - Soket Kitleri — Kolay Seçim İçin

RockStar® Kit'leri kendinizin monte edebileceği parçalardan oluşur. Tüm gerekli parçaları içinde bulunduran Kit'ler sanayi tipi fiş soketleri tek bir sipariş numarasında bir araya getirir. RockStar® Kit'ler, fiş soketler, pinler, fiş kutuları, priz kutuları ve kablo rakorlarını içerirler.

Avantajları:

- Kolay seçim
- Kolay tasarım
- Kolay depolama





HDC-KIT-HE 10.111



HDC-KIT-HE 06.100



HDC HE 6 MS



HDC HE 6 MT



HDC 10B TOBU 1PG16G



HDC 10B TSBU 1PG16G



HDC HE 16 MT

Tip	V / A	Kutup Sayısı	Sipariş No	Fiyat/Birim	Ambalaj
<b>HE Serisi Komple Sanayi Tipi Fiş-Soketler (Kit'ler)</b>					
<b>Yukardan Rakorlu</b>					
HDC-KIT-HA 03.300	500 V / 24 A	3-kutup(Metal Kutu)	1712560000	271,20 TL	1
HDC-KIT-HA 03.301	250 V / 22 A	3-kutup(Plastik Kutu)	1712570000	338,80 TL	1
HDC-KIT-HA 04.400	250 V / 22 A	4-kutup(Metal Kutu)	1712590000	286,15 TL	1
HDC-KIT-HA 04.401	250 V / 22 A	4-kutup(Plastik Kutu)	1712600000	353,90 TL	1
HDC-KIT-HE 06.101	500 V / 24 A	6-kutup(Metal Kutu)	1712660000	508,00 TL	1
HDC-KIT-HE 10.111	500 V / 16 A	10-kutup(Metal Kutu)	1712670000	646,00 TL	1
HDC-KIT-HE 16.121	500 V / 16 A	16-kutup(Metal Kutu)	1712680000	735,00 TL	1
HDC-KIT-HE 24.131	500 V / 16 A	24-kutup(Metal Kutu)	1712690000	778,00 TL	1
<b>Yandan Rakorlu</b>					
HDC-KIT-HE 06.100	500 V / 24 A	6-kutup(Metal Kutu)	1712460000	429,65 TL	1
HDC-KIT-HE 10.110	500 V / 16 A	10-kutup(Metal Kutu)	1712510000	579,00 TL	1
HDC-KIT-HE 16.120	500 V / 16 A	16-kutup(Metal Kutu)	1712520000	738,00 TL	1
HDC-KIT-HE 24.130	500 V / 16 A	24-kutup(Metal Kutu)	1712530000	803,00 TL	1
HDC-KIT-HE 32.140	400 V / 16 A	32-kutup(Metal Kutu)	1712540000	1.524,00 TL	1
HDC-KIT-HE 48.150	500 V / 16 A	48-kutup(Metal Kutu)	1712550000	2.126,00 TL	1
<b>HE - Tipi Fiş-Soketler ( Vidalı / yaylı bağlantı ) / Universal Konnektörler</b>					
<b>6 Kutup</b>					
HDC HE 6 MS	500 V / 24 A	6 kutup (Fiş)	1200000000	89,70 TL	1
HDC HE 6 FS	500 V / 24 A	6 kutup (Soket)	1200200000	89,70 TL	1
HDC HE 6 MT	500 V / 24 A	6 kutup (Fiş)	1745820000	89,70 TL	1
HDC HE 6 FT	500 V / 24 A	6 kutup (Soket)	1745760000	89,70 TL	1
HDC 06B TOLU 1PG16G		Yukarıdan Rakorlu	1652640000	109,75 TL	1
HDC 06B TSLU 1PG16G		Yandan Rakorlu	1652520000	109,75 TL	1
HDC 06B ALU		Makina Tipi	1202100000	104,80 TL	1
HDC 06B ALU N		Makina Tipi	2488560000	115,35 TL	1
HDC 06B SLU 1PG16G		Duvar Tipi	1652750000	163,30 TL	1
HDC 06B KLU 1PG16G		Seyyar Tip	1653200000	216,80 TL	1
HDC 06B DODL 2B0	Koruma Kapağı		1665200000	168,65 TL	1
<b>10 Kutup</b>					
HDC HE 10 MS	500 V / 16 A	10 kutup (Fiş)	1203900000	89,70 TL	1
HDC HE 10 FS	500 V / 16 A	10 kutup (Soket)	1204100000	89,70 TL	1
HDC HE 10 MT	500 V / 16 A	10 kutup (Fiş)	1745830000	119,10 TL	1
HDC HE 10 FT	500 V / 16 A	10 kutup (Soket)	1745770000	119,10 TL	1
HDC 10B TOBU 1PG16G		Yukarıdan Rakorlu	1654220000	154,80 TL	1
HDC 10B TSBU 1PG16G		Yandan Rakorlu	1654070000	154,80 TL	1
HDC 10B ABU		Makina Tipi	1205000000	159,70 TL	1
HDC 10B ABU N		Makina Tipi	2488580000	166,90 TL	1
HDC 10B SBU 1PG16G		Duvar Tipi	1654370000	246,00 TL	1
HDC 10B KBU 1PG16G		Seyyar Tip	1654580000	200,55 TL	1
HDC 10B DODQ 4B0	Koruma Kapağı		1665230000	149,50 TL	1
<b>16 Kutup</b>					
HDC HE 16 MS	500 V / 16 A	16 kutup (Fiş)	1207500000	134,10 TL	1
HDC HE 16 FS	500 V / 16 A	16 kutup (Soket)	1207700000	134,10 TL	1
HDC HE 16 MT	500 V / 16 A	16 kutup (Fiş)	1745840000	157,75 TL	1
HDC HE 16 FT	500 V / 16 A	16 kutup (Soket)	1745780000	157,75 TL	1
HDC 16B TOBU 1PG21G		Yukarıdan Rakorlu	1656590000	163,30 TL	1
HDC 16B TSBU 1PG21G		Yandan Rakorlu	1656480000	159,70 TL	1
HDC 16B ABU		Makina Tipi	1208600000	159,70 TL	1

Serinin devamı sayfa 53



HDC HE 24 MS



HDC HE 24 MT



HDC HE 16 MS



HDC 32B TOBU 1PG29G



HDC HDD 24 MC



HDC-C-HD-SM0.75-1.00AG



CTX CM 1.6/2.5

Tip	V / A	Kutup Sayısı	Sipariş No	Fiyat/Birim	Ambalaj
HDC 16B ABU N		Makina Tipi	2488590000	173,65 TL	1
HDC 16B SBU 1PG21G		Duvar Tipi	1656720000	258,70 TL	1
HDC 16B KBU 1PG21G		Seyyar Tip	1657270000	213,90 TL	1
HDC 16B DODQ 4B0		Koruma Kapağı	1665260000	187,05 TL	1
<b>24 Kutup</b>					
HDC HE 24 MS	500 V / 16 A	24 kutup (Fiş)	1211100000	191,45 TL	1
HDC HE 24 FS	500 V / 16 A	24 kutup (Soket)	1211300000	191,45 TL	1
HDC HE 24 MT	500 V / 16 A	24 kutup (Fiş)	1745850000	191,45 TL	1
HDC HE 24 FT	500 V / 16 A	24 kutup (Soket)	1745790000	191,45 TL	1
HDC 24B TOBU 1PG21G		Yukarıdan Rakorlu	1661370000	174,80 TL	1
HDC 24B TSBV 1PG21G		Yandan Rakorlu	1661230000	174,80 TL	1
HDC 24B ABU		Makina Tipi	1212400000	180,45 TL	1
HDC 24B ABU N		Makina Tipi	2488600000	185,25 TL	1
HDC 24B SBU 1PG21G		Duvar Tipi	1661510000	296,50 TL	1
HDC 24B KBU 1PG21G		Seyyar Tip	1661720000	258,65 TL	1
HDC 24B DODQ 4B0		Koruma Kapağı	1665630000	230,10 TL	1
<b>32 Kutup</b>					
HDC HE 16 MS	500 V / 16 A	16 kutup (Fiş)	1207500000	134,10 TL	1
HDC HE 16 MS 17-32	500 V / 16 A	32 kutup (Fiş)	1215700000	149,30 TL	1
HDC HE 16 FS	500 V / 16 A	16 kutup (Soket)	1207700000	134,10 TL	1
HDC HE 16 FS 17-32	500 V / 16 A	32 kutup (Soket)	1216100000	149,30 TL	1
HDC HE 16 MT	500 V / 16 A	16 kutup (Fiş)	1745840000	157,75 TL	1
HDC HE 16 MT 17-32	500 V / 16 A	32 kutup (Fiş)	1745860000	150,65 TL	1
HDC HE 16 FT	500 V / 16 A	16 kutup (Soket)	1745780000	157,75 TL	1
HDC HE 16 FT 17-32	500 V / 16 A	32 kutup (Soket)	1745800000	150,65 TL	1
HDC 32B TOBU 1PG29G		Yukarıdan Rakorlu	1666870000	433,50 TL	1
HDC 32B TSBV 1PG29G		Yandan Rakorlu	1666840000	444,10 TL	1
HDC 32B ABU		Makina Tipi	1217800000	357,20 TL	1
HDC 32B SBU 2PG29G		Duvar Tipi	1666920000	490,65 TL	1
HDC 32B KBU 1PG29G		Seyyar Tip	1902740000	693,00 TL	1
<b>HDD Serisi ( Çoklu Crimp Bağlantı )</b>					
<b>24 Kutup</b>					
HDC HDD 24 MC	250 V / 10 A	24 kutup (Fiş)	1651150000	185,35 TL	1
HDC HDD 24 FC	250 V / 10 A	24 kutup (Soket)	1651160000	184,75 TL	1
HDC 06B TOLU 1PG16G		Yukarıdan Rakorlu	1652640000	109,75 TL	1
HDC 06B TSLU 1PG16G		Yandan Rakorlu	1652520000	109,75 TL	1
HDC 06B ALU		Makina Tipi	1202100000	104,80 TL	1
HDC 06B ALU N		Makina Tipi	2488560000	115,35 TL	1
HDC 06B SLU 1PG16G		Duvar Tipi	1652750000	163,30 TL	1
HDC 06B KLU 1PG16G		Seyyar Tip	1653200000	216,80 TL	1
<b>HDD Serisi ( Çoklu Crimp Bağlantı )</b>					
<b>Aksesuarlar</b>					
HDC-C-HD-SM0.75-1.00AG	0.75- 1.00 kablo kesiti / Erkek		1601750000	8,40 TL	100
HDC-C-HD-BM0.75-1.00AG	0.75- 1.00 kablo kesiti / Dişi		1601760000	8,40 TL	100
HDC-C-HD-SM1.5AG	1.5 kablo kesiti / Erkek		1651550000	8,40 TL	100
HDC-C-HD-BM1.5AG	1.5 kablo kesiti / Dişi		1651600000	8,40 TL	100
HDC-C-HD-SM2.5AG	2.5 kablo kesiti / Erkek		1651560000	8,40 TL	100
HDC-C-HD-BM2.5AG	2.5 kablo kesiti / Dişi		1651610000	8,40 TL	100
CTX CM 1.6/2.5	Crimp kontak sıkma el aleti / 0.14mm <sup>2</sup> ... 4mm <sup>2</sup>		9018490000	7.628,00 TL	1
REMOVAL TOOL HD	Sökme Aparatı		1866730000	737,00 TL	1



## Rockstar Sanayi Tipi Fiş-Soket



HDC HDD 42 MC



HDC 10B TOBU 1PG16G



HDC 10B TSBU 1PG16G



HDC HDD 72 MC



HDC HDD 108 MC



HDC HSB 6 MS



HDC 32B TOBU 1PG29G

Tip	V / A	Kutup Sayısı	Sipariş No	Fiyat/Birim	Ambalaj
<b>HDD Serisi ( Çoklu Crimp Bağlantı )</b>					
<b>42 Kutup</b>					
HDC HDD 42 MC	250 V / 10 A	42 kutup Fiş	1651170000	203,55 TL	1
HDC HDD 42 FC	250 V / 10 A	42 kutup Soket	1651180000	203,55 TL	1
HDC 10B TOBU 1PG16G		Yukarıdan Rakorlu	1654220000	154,80 TL	1
HDC 10B TSBU 1PG16G		Yandan Rakorlu	1654070000	154,80 TL	1
HDC 10B ABU		Makina Tipi	1205000000	159,70 TL	1
HDC 10B ABU N		Makina Tipi	2488580000	166,90 TL	1
HDC 10B SBU 1PG16G		Duvar Tipi	1654370000	246,00 TL	1
HDC 10B KBU 1PG16G		Seyyar Tip	1654580000	200,55 TL	1

Tip	V / A	Açıklama	Sipariş No	Fiyat/Birim	Ambalaj
<b>HDD Serisi ( Çoklu Crimp Bağlantı )</b>					
<b>72 Kutup</b>					
HDC HDD 72 MC	250 V / 10 A	72 Kutup fiş	1651190000	210,10 TL	1
HDC HDD 72 FC	250 V / 10 A	72 Kutup soket	1651200000	210,10 TL	1
HDC 16B TOBU 1PG21G		Yukarıdan Rakorlu	1656590000	163,30 TL	1
HDC 16B TSBU 1PG21G		Yandan Rakorlu	1656480000	159,70 TL	1
HDC 16B ABU		Makina Tipi	1208600000	159,70 TL	1
HDC 16B ABU N		Makina Tipi	2488590000	173,65 TL	1
HDC 16B SBU 1PG21G		Duvar Tipi	1656720000	258,70 TL	1
HDC 16B KBU 1PG21G		Seyyar Tip	1657270000	213,90 TL	1

Tip	V / A	Kutup Sayısı	Sipariş No	Fiyat/Birim	Ambalaj
<b>108 Kutup</b>					
HDC HDD 108 MC	250 V / 10 A	108 Kutup fiş	1651210000	226,15 TL	1
HDC HDD 108 FC	250 V / 10 A	108 Kutup soket	1651220000	226,15 TL	1
HDC 24B TOBU 1PG21G		Yukarıdan Rakorlu	1661370000	174,80 TL	1
HDC 24B TSBU 1PG21G		Yandan Rakorlu	1661230000	174,80 TL	1
HDC 24B ABU		Makina Tipi	1212400000	180,45 TL	1
HDC 24B ABU N		Makina Tipi	2488600000	185,25 TL	1
HDC 24B SBU 1PG21G		Duvar Tipi	1661510000	296,50 TL	1
HDC 24B KBU 1PG21G		Seyyar Tip	1661720000	258,65 TL	1

Tip	V / A	Kutup Sayısı	Sipariş No	Fiyat/Birim	Ambalaj
<b>HSB - Tipi Güç Konnektörleri</b>					
<b>6 Kutup</b>					
HDC HSB 6 MS	400 V / 35 A	6 kutup (Fiş)	1498700000	335,60 TL	1
HDC HSB 6 FS	400 V / 35 A	6 kutup (Soket)	1498900000	335,60 TL	1
HDC 16B TOBU 1PG21G		Yukarıdan Rakorlu	1656590000	163,30 TL	1
HDC 16B TSBU 1PG21G		Yandan Rakorlu	1656480000	159,70 TL	1
HDC 16B ABU		Makina Tipi	1208600000	159,70 TL	1
HDC 16B ABU N		Makina Tipi	2488590000	173,65 TL	1
HDC 16B SBU 1PG21G		Duvar Tipi	1656720000	258,70 TL	1
HDC 16B KBU 1PG21G		Seyyar Tip	1657270000	213,90 TL	1

Tip	V / A	Kutup Sayısı	Sipariş No	Fiyat/Birim	Ambalaj
<b>12 Kutup</b>					
HDC HSB 6 MS	400 V / 35 A	6 kutup (Fiş)	1498700000	335,60 TL	1
HDC HSB 6 MS 7 - 12	400 V / 35 A	12 kutup (Fiş)	1498800000	328,05 TL	1
HDC HSB 6 FS	400 V / 35 A	6 kutup (Soket)	1498900000	335,60 TL	1
HDC HSB 6 FS 7 - 12	400 V / 35 A	12 kutup (Soket)	1499000000	328,05 TL	1
HDC 32B TOBU 1PG29G		Yukarıdan Rakorlu	1666870000	433,50 TL	1
HDC 32B TSBU 1PG29G		Yandan Rakorlu	1666840000	444,10 TL	1
HDC 32B ABU		Makina Tipi	1217800000	357,20 TL	1
HDC 32B SBU 2PG29G		Duvar Tipi	1666920000	490,65 TL	1
HDC 32B KBU 1PG29G		Seyyar Tip	1902740000	693,00 TL	1



HDC IP68 HP 24B TO



HDC IP68 HP 24B TO



STV S 2 SS



VG PG11-K67

Tip	Açıklama	Sipariş No	Fiyat/Birim	Ambalaj	
<b>HDC - HP Tipi 250A / 550A GÜÇ KONNEKTÖRLERİ</b>					
<b>250 A / 4000 V</b>					
HDC IP68 HP 24B TO	Fiş Koruma Kılıfı	1079930000	1.322,00 TL	1	
HDC IP68 HP 24B AS S	Sabit Fiş Koruma Kılıfı	1079920000	1.893,00 TL	1	
HDC IP68 HP 24B A	Makine Tipi	1120040000	678,00 TL	1	
HDC IP68 24B HP FRAME	Çerçeve	1282820000	549,00 TL	1	
<b>550 A / 4000 V</b>					
HDC IP68 HP 24B TO	Fiş Koruma Kılıfı	1079930000	1.322,00 TL	1	
HDC IP68 HP 24B AS S	Sabit Fiş Koruma Kılıfı	1079920000	1.893,00 TL	1	
HDC IP68 HP 24B A	Makine Tipi	1120040000	678,00 TL	1	
HDC IP68 24B HP FRAME	Çerçeve	1282820000	549,00 TL	1	
<b>Aksesuarlar</b>					
Crimp Contact		Sorunuz	Sorunuz	Sorunuz	
EMC-Shield Lever		Sorunuz	Sorunuz	Sorunuz	
Touch-Safe Protection Safe		Sorunuz	Sorunuz	Sorunuz	
Mounting Frame		Sorunuz	Sorunuz	Sorunuz	
Cable Glands		Sorunuz	Sorunuz	Sorunuz	
<b>Fiş-Soket Klemensleri (STV S Tipi)</b>					
STV S 2 SS	2 Kutuplu Fiş	1611950000	42,10 TL	10	
STV S 2 SB	2 Kutuplu Soket	1611960000	52,70 TL	10	
STV S 3 SS	3 Kutuplu Fiş	1611980000	46,35 TL	10	
STV S 3 SB	3 Kutuplu Soket	1611990000	66,55 TL	10	
STV S 4 SS	4 Kutuplu Fiş	1612010000	70,15 TL	10	
STV S 4 SB	4 Kutuplu Soket	1612020000	89,05 TL	10	
STV S 5 SS	5 Kutuplu Fiş	1612040000	105,90 TL	10	
STV S 5 SB	5 Kutuplu Soket	1612050000	106,55 TL	10	
STV S 6 SS	6 Kutuplu Fiş	1612070000	78,40 TL	10	
STV S 6 SB	6 Kutuplu Soket	1612080000	114,35 TL	10	
STV S 8 SS	8 Kutuplu Fiş	1612130000	103,90 TL	10	
STV S 8 SB	8 Kutuplu Soket	1612140000	156,80 TL	10	
STV S 9 SS	9 Kutuplu Fiş	1612160000	127,95 TL	10	
STV S 9 SB	9 Kutuplu Soket	1612170000	158,05 TL	10	
STV S 10 SS	10 Kutuplu Fiş	1612190000	110,80 TL	10	
STV S 10 SB	10 Kutuplu Soket	1612200000	164,70 TL	10	
<b>Fiş-Soket Klemensleri (STV-STW Tipi)</b>					
STV 2/10 S/B	Komple	0644960000	289,65 TL	10	
STV 2/10 LB 90 3.2	Lehim pinli, Soket	1305360000	268,80 TL	10	
STV 2/10 LS 90 3.2	Lehim pinli, Fiş	1305760000	189,30 TL	10	
STW 2/20/D S/B TS ZE	Raya monte edilebilir	1268360000	1.344,00 TL	5	
STW 2/20/C S/B TS ZE	Raya monte edilebilir	0291660000	1.344,00 TL	5	
<b>Plastik Rakorlar IP 67</b>					
VG PG11-K67	PG 11	22	1909780000	11,00 TL	50
VG PG16-K67	PG 16	27	1909800000	12,50 TL	50
VG PG21-K67	PG 21	33	1909810000	12,10 TL	25
VG PG29-K67	PG 29	42	1909820000	26,10 TL	20
<b>Metal Rakorlar IP 67</b>					
VG 11-MS68	Kablo Rakoru-PG11-IP68	20	1569080000	45,65 TL	50
VG 16-MS68	Kablo Rakoru-PG16-IP68	24	1569100000	61,40 TL	25
VG 21-MS68	Kablo Rakoru-PG21-IP68	30	1569110000	101,85 TL	25
VG 29-MS68	Kablo Rakoru-PG29-IP68	40	1569120000	160,35 TL	10

## HDC Moduplug- Sanayi Tipi Fiş-Soket



HDC MHP 200 MC



HDC MHP 70 MC



HDC MHE 6 FC



HDC MHD 36 MC



HDC MBUS 2 MC



HDC MDU



HDC MRJ45 B MI



HDC MF 6B AB

Tip	Açıklama	Kutup Sayısı / Slot Boyutu	Sipariş No	Fiyat/Birim	Ambalaj
<b>Güç Modülleri</b>					
* HDC MHP 200 MC	200A / 1.000V	1 / 1,5	2548900000	141,10 TL	1
* HDC MHP 200 FC	200A / 1.000V	1 / 1,5	2549260000	141,10 TL	1
* HDC MHP 100 MC	100A / 1.000V	2 / 1,5	1429060000	132,45 TL	1
* HDC MHP 100 FC	100A / 1.000V	2 / 1,5	1429080000	132,45 TL	1
* HDC MHP 70 MC	70A / 1.000V	2 / 1	2668190000	77,70 TL	1
* HDC MHP 70 FC	70A / 1.000V	2 / 1	2668180000	77,70 TL	1
* HDC MHX 4P MC	40A / 830V	4 / 1	1428950000	108,35 TL	1
* HDC MHX 4P FC	40A / 830V	4 / 1	1428970000	108,35 TL	1
* HDC MHX 3 MC	40A / 690V	3 / 1	1429340000	57,00 TL	1
* HDC MHX 3 FC	40A / 690V	3 / 1	1429350000	57,00 TL	1
* HDC MHE 6P MC	16A / 830V	6 / 1	1505650000	71,00 TL	1
* HDC MHE 6P FC	16A / 830V	6 / 1	1505660000	71,00 TL	1
* HDC MHE 20 MC	16A / 500V	20 / 2	1428910000	168,00 TL	1
* HDC MHE 20 FC	16A / 500V	20 / 2	1428930000	168,00 TL	1
* HDC MHE 8 MC	16A / 400V	8 / 1	1428880000	74,35 TL	1
* HDC MHE 8 FC	16A / 400V	8 / 1	1428890000	74,35 TL	1
* HDC MHE 6 MC	16A / 500V	6 / 1	1429360000	89,10 TL	1
* HDC MHE 6 FC	16A / 500V	6 / 1	1429370000	89,10 TL	1
* HDC MHE 5 MP	16A / 400V	5 / 1	2636180000	134,40 TL	1
* HDC MHE 5 FP	16A / 400V	5 / 1	2636190000	134,40 TL	1
* HDC MHE 4 MP	16A / 250V	4 / 0,5	2635980000	147,00 TL	1
* HDC MHE 4 FP	16A / 250V	4 / 0,5	2635990000	147,00 TL	1
* HDC MHE 4X MP	16A / 250V	4 / 0,5	2636070000	153,30 TL	1
* HDC MHE 4X FP	16A / 250V	4 / 0,5	2636060000	153,30 TL	1
* HDC MHE 4X2 MP	16A / 250V	4 / 0,5	2636090000	147,00 TL	1
* HDC MHE 4X2 FP	16A / 250V	4 / 0,5	2636080000	147,00 TL	1
* HDC MHD 36 MC	10A / 250V	36 / 2	1428860000	108,35 TL	1
* HDC MHD 36 FC	10A / 250V	36 / 2	1428870000	108,35 TL	1
* HDC MHD 12 MC	10A / 250V	12 / 1	1428840000	42,15 TL	1
* HDC MHD 12 FC	10A / 250V	12 / 1	1428850000	42,15 TL	1
<b>Data Modülleri</b>					
* HDC MBUS 2 MC	-	2 / 1	1428990000	6,20 €	1
* HDC MBUS 2 FC	-	2 / 1	1429020000	6,20 €	1
<b>Dummy Modülü</b>					
* HDC MDU	Boş Modül	1 / 1	1429040000	45,15 TL	1
<b>RJ45 Modülleri</b>					
* HDC MRJ45 GC F	Dişi Modül		2592030000	246,40 TL	1
* HDC MRJ45 8PLUG MC	Erkek Modül	RJ45 crimp	2592250000	207,90 TL	1
* HDC MRJ45 A MI	Erkek Modül	TIA-568A	2592220000	309,55 TL	1
* HDC MRJ45 B MI	Erkek Modül	EIA/TIA T568 B	2592230000	309,55 TL	1
* HDC MRJ45 P MI	Erkek Modül	PROFINET	2592240000	309,55 TL	1
* HDC MRJ45 ABP MI	Erkek Modül	TIA-568A, EIA/TIA T568 B, PROFINET	2592210000	280,00 TL	1
* HDC MRJ45 PCADP MC	Erkek Modül	HDC MRJ45 PCADP MC	2592260000	87,30 TL	1
<b>Pnömatik Modülleri</b>					
* HDC MPN 2	2 Kutup		2637320000	36,10 TL	1
* HDC MPN 3	3 Kutup		2637340000	36,10 TL	1
<b>Çerçeve Modülleri</b>					
* HDC MF 6B AB	Size 3	2 slot bulunur	1428920000	185,90 TL	1
* HDC MF 6B BA	Size 3	2 slot bulunur	1428940000	185,90 TL	1
* HDC MF 10B AC	Size 4	3 slot bulunur	1428960000	185,90 TL	1
* HDC MF 10B CA	Size 4	3 slot bulunur	1428980000	185,15 TL	1
* HDC MF 16B AD	Size 6	4 slot bulunur	1429010000	185,15 TL	1
* HDC MF 16B DA	Size 6	4 slot bulunur	1429030000	185,15 TL	1
* HDC MF 24B AF	Size 8	6 slot bulunur	1429050000	299,55 TL	1
* HDC MF 24B FA	Size 8	6 slot bulunur	1429070000	299,55 TL	1

## El Aletleri

### Hidrolik Skp Pabuç Sıkma Ürünleri

Skp pabuç sıkma ailesinin yeni üyeleri tamamen hidrolik çalışma prensibi ile güç sarfiyatını en aza düşürüyor. Tüm kesit aralıklarında, farklı sıkma şekillerini destekleyen çene yapılarıyla beraber bakır ve alüminyum hem izoleli hem izolesiz pabuçlar için çözümler sunmaktadır. Manuel ve otomatik olarak her el aleti için iki farklı opsiyon bulunmaktadır.

### Kesme

Weidmüller kesme aletleri profesyonel kablo işçiliğinin bütün kriterlerini yerine getirir. Tüm kesme aletleri için istenen iletken formunu bozmadan, düz ve pürüzsüz bir kesimdir. Her türlü iletken kesimi için gerekli el aletini Weidmüller ürün ailesi içerisinde bulabilirsiniz.

### Kablo Soyma

Kablo soyma, iletkenin dış izolasyonunun sıyrılıp alınması anlamına gelir. Soyma esnasında şunlar garantilenmelidir: Soyma ölçüsü dikkate alınmalı ve iletkene zarar vermemelidir. Aynı şart geride kalan izolasyon için de geçerlidir.

### Sıkma

İzolasyonu soyulan kablo ucuna yüksük pabuç yada özel bağlantı konnektörleri elektriksel ve mekaniksel kriterlere uygun olarak sıkıştırılır. Weidmüller sıkma aletleri kablo uçlarını sıkmak için çok geniş bir ürün ailesine sahiptir.

### Klemens Tornavidaları

Tornavidaların sap yapısı, kullanıcının tutuş konforu göz önünde bulundurularak sürekli geliştirme sonunda özel olarak tasarlanmıştır. Çeşitli çalışma tarzlarına uygundur.

### Test ve Ölçü Aletleri

Test ve ölçü aletleri elektrik tesislerinin yapım ve bakımı ve tamirinde büyük önem taşırlar. Weidmüller'in ürün ailesi ile standartlara uygun şekilde test ve ölçüm yapabilirsiniz.

### Takım Çantaları

Elektrik, Elektronik ve otomasyon işçiliğinde kullanım için değişik ihtiyaçlara yönelik kombine edilmiş profesyonel el aletleri setlerinden oluşur.





KT 8



KT 55



TSLD 5



STRIPAX 16



AM 12



STRIPAX PLUS 2.5



HTF 63

Tip	Açıklama	Sipariş No	Fiyat/Birim	Ambalaj
<b>Kablo Kesme</b>				
KT 8	8 mm max. Çap/Örgü kesit:16mm <sup>2</sup> /Çok Damarlı kesit:16mm <sup>2</sup> /Tek Damarlı Kesit:16mm <sup>2</sup>	9002650000	1.001,00 TL	1
KT 12	12 mm max. Çap/Örgü kesit:25mm <sup>2</sup> /Çok Damarlı kesit:35mm <sup>2</sup> /Tek Damarlı Kesit:16mm <sup>2</sup>	9002660000	1.086,00 TL	1
KT 14	14 mm max. Çap/Örgü kesit:35mm <sup>2</sup> /Çok Damarlı kesit:70mm <sup>2</sup> /Tek Damarlı Kesit:16mm <sup>2</sup>	1157820000	1.197,00 TL	1
KT 22	22 mm max. Çap/Örgü kesit:50mm <sup>2</sup> /Çok Damarlı kesit:95mm <sup>2</sup> /Tek Damarlı Kesit:25mm <sup>2</sup>	1157830000	1.484,00 TL	1
KTF 36	35 mm max. Çap/Örgü kesit:300mm <sup>2</sup> /Çok Damarlı kesit:300mm <sup>2</sup>	9002190000	10.563,00 TL	1
KT 45 R	45 mm max. Çap/Örgü kesit:300mm <sup>2</sup> /Çok Damarlı kesit:400mm <sup>2</sup>	9202040000	8.803,00 TL	1
KT 55	55 mm max. Çap/Örgü kesit:500mm <sup>2</sup> /Çok Damarlı kesit:500mm <sup>2</sup>	9202060000	12.797,00 TL	1
KT 80	80 mm max. Çap/Örgü kesit:630mm <sup>2</sup> /Çok Damarlı kesit:630mm <sup>2</sup>	9202080000	24.156,00 TL	1
<b>Üst Köprü, Kanal ve Ray Kesme</b>				
WAW 1 NEUTRAL	WQV 2.5 ile WQV 35 arasındaki üst köprüleri kesmek için	9004500000	1.129,00 TL	1
WAW 2	Klemens Köprü Açma El Aleti	9004510000	1.118,00 TL	1
KT ZQV	Z serisi üst köprüleri kırma/kesme el aleti	9002170000	874,00 TL	1
VKSW	Kanal Kesme Makinası (125mm genişliğe kadar olan kablo kanalları için)	1137530000	22.400,00 TL	1
TSLD 5	Ray Kesme Makinası	9918700000	37.933,00 TL	1
<b>Kablo Soyma</b>				
STRIPAX	0,08...10mm <sup>2</sup> arası kesit PVC kablolar için kesme ve soyma	9005000000	1.158,00 TL	1
ERME 10 <sup>2</sup> SPX 4	Stripax için yedek bıçak	1119030000	353,60 TL	1
STRIPAX 16	6...16mm <sup>2</sup> arası kesit PVC kablolar için	9005610000	2.937,00 TL	1
ERME 16 <sup>2</sup> SPX 4	Stripax 16 için yedek bıçak	1119040000	704,00 TL	1
STRIPAX ULTIMATE	Halogen Free Kablolar İçin 0.25...6 mm <sup>2</sup> arası kesitler için	1468880000	1.376,00 TL	1
STRIPAX ULTIMATE XL	Halogen Free Kablolar İçin 2.5...10 mm <sup>2</sup> arası kesitler için	1512780000	1.659,00 TL	1
multi-stripax 6-16	6, 10, 16 mm <sup>2</sup> kesite sahip sert ve yumuşak izolasyonlu kablolar için	9202210000	5.741,00 TL	1
AM 12	0.5...12.5mm çap aralığına sahip UTP ve STP data kabloları için	9030060000	627,00 TL	1
AM 16	6...17 mm çap aralığına sahip PVC kablolar için	9204190000	1.467,00 TL	1
AM 25	6...25mm çap aralığına sahip PVC kablolar için	9001540000	1.086,00 TL	1
AM 35	25...36mm çap aralığına sahip PVC kablolar için	9001080000	1.086,00 TL	1
IE-CST	2.5...8 mm çap aralığına sahip Coaxial ve Data kablolar için	9204350000	1.352,00 TL	1
CST	2.5...8 mm çap aralığına sahip Coaxial ve Data kablolar için	9030500000	983,00 TL	1
CST Cassette	CST İçin Bıçak Kaseti, Çeşitleri İçin Bilgi Alınız	9032xx0000	Sorunuz	Sorunuz
CST VARIO	2.5...8 mm çap aralığına sahip Coaxial ve Data kablolar için	9005700000	1.639,00 TL	1
IE-CST Weidmüller Ethernet kablolarına göre ayarlanmış bıçak kasetini içermektedir. CST ürünü herhangi bir bıçak kaseti içermemektedir.Ek olarak seçilip sipariş edilmelidir.				
<b>Yüksük Sıkma</b>				
STRIPAX PLUS 2.5	0,5...2,5mm <sup>2</sup> kesit aralığına sahip PVC kablolar için Kesme,Soyma ve Sıkma	9020000000	3.877,00 TL	1
PZ 1.5	0.14...1.5mm <sup>2</sup> kesit aralığında V tipi sıkma	9005990000	2.760,00 TL	1
PZ 10 HEX	0.14...10mm <sup>2</sup> kesit aralığında tek yuvada hexagonal sıkma	1445070000	4.477,00 TL	1
PZ 10 SQR	0.14...10mm <sup>2</sup> kesit aralığında tek yuvada kare sıkma	1445080000	3.678,00 TL	1
PZ 6/5	0.25...6mm <sup>2</sup> kesit aralığında 5 farklı yuvada W tipi sıkma	9011460000	3.804,00 TL	1
PZ 6 Roto	0.14...6mm <sup>2</sup> kesit aralığında tek yuvada V tipi sıkma-Dönebilir	9014350000	3.361,00 TL	1
PZ 6 ROTO L	0.14...6mm <sup>2</sup> kesit aralığında tek yuvada V tipi sıkma-Dönebilir,Kitlenebilir çene	1444050000	3.361,00 TL	1
PZ 16	6...16mm <sup>2</sup> kesit aralığında 3 farklı yuvada W tipi sıkma	9012600000	3.804,00 TL	1
PZ 50	25...50mm <sup>2</sup> kesit aralığında 3 farklı yuvada W tipi sıkma	9006450000	5.853,00 TL	1
<b>Faston Papuç Sıkma</b>				
HTF 28	0.1...1mm <sup>2</sup> kesit aralığında papuç bağlantı genişliği:2.8mm	9013090000	5.486,00 TL	1
HTF 48	0.5...2.5mm <sup>2</sup> kesit aralığında papuç bağlantı genişliği:4.8mm	9013080000	5.486,00 TL	1
HTF 63	0.5...2.5mm <sup>2</sup> kesit aralığında papuç bağlantı genişliği:6.3mm	9013400000	5.637,00 TL	1
CTF 63	0,5...6mm <sup>2</sup> kesit aralığında papuç bağlantı genişliği:6.3mm	9202860000	8.684,00 TL	1



CTI 6 G



HTN 21



CTX CM 1.6/2.5



TT 864 RS



APG 80



IE-KO-HAT



SDIS 0.4X2.5X75

Tip	Açıklama	Sipariş No	Fiyat/Birim	Ambalaj
<b>İzoleli Papuç Sıkma</b>				
CTI 6 G	0,5...6 mm <sup>2</sup> kesit aralığında Amerika standardına uygun paralel sıkma	9202850000	3.731,00 TL	1
CTI 6	0,5...6 mm <sup>2</sup> kesit aralığında Avrupa standardına uygun çift sıkma	9006120000	3.731,00 TL	1
HTI 15	0,5...2,5 mm <sup>2</sup> kesit aralığında Avrupa standardına uygun çift sıkma	9014400000	2.717,00 TL	1
<b>İzolesiz Papuç Sıkma</b>				
HTN 21	0,5...6 mm <sup>2</sup> kesit aralığında (nokta baskı sıkma)	9014610000	3.731,00 TL	1
CTN 25 D4	10...25 mm <sup>2</sup> kesit aralığında yuvarlak tip crimp kontak sıkma (nokta baskı sıkma)	9006220000	5.132,00 TL	1
CTN 25 D5	10...25 mm <sup>2</sup> kesit aralığında yuvarlak tip crimp kontak sıkma (paralel hexagonal baskı sıkma)	9006230000	5.132,00 TL	1
<b>Crimp Kontak Sıkma</b>				
CTX CM 1.6/2.5	Crimp kontak sıkma el aleti / 0.14mm <sup>2</sup> ... 4mm <sup>2</sup>	9018490000	7.628,00 TL	1
CTX CM 3.6	4...10 mm <sup>2</sup> kesit aralığında yuvarlak HD ve Concept M3 kontaklar için	9018480000	7.628,00 TL	1
CTIN CM 1.6/2.5	0.14...4 mm <sup>2</sup> kesit aralığında yuvarlak HD,HE,HX ve M10,M5,M3 kontaklar için(Elektronk Kontrol)	9205430000	22.308,00 TL	1
CTIN CM 3.6	1,5...10 mm <sup>2</sup> kesit aralığında yuvarlak HX ve M3 kontaklar için(Elektronk Kontrol)	9205440000	22.308,00 TL	1
HTX LWL	Fiber Optik Konnektör Sıkma	9011360000	4.581,00 TL	1
<b>Data ve Tel. Konnektör Sıkma</b>				
TT 864 RS	4,6 ve 8 pin sıkma	9008120000	5.425,00 TL	1
TT 1064 RS	4,6 ve 10 pin sıkma	9008190000	7.722,00 TL	1
<b>SKP Papuç Sıkma - MTR</b>				
APG 80	6 - 300 mm <sup>2</sup> Hidrolik Papuç Sıkma Aleti (Şarjlı Otomatik)	1502390000	61.600,00 TL	1
ES APG/HPG80 HEX 6	6 mm <sup>2</sup> Çene - Bakır Papuçlar İçin	1502600000	2.131,00 TL	1
ES APG/HPG80 HEX 10	10 mm <sup>2</sup> Çene - Bakır Papuçlar İçin	1502620000	2.131,00 TL	1
ES APG/HPG80 HEX 16	16 mm <sup>2</sup> Çene - Bakır Papuçlar İçin	1502630000	2.131,00 TL	1
ES APG/HPG80 HEX 25	25 mm <sup>2</sup> Çene - Bakır Papuçlar İçin	1502640000	2.131,00 TL	1
ES APG/HPG80 HEX 35	35 mm <sup>2</sup> Çene - Bakır Papuçlar İçin	1502650000	2.131,00 TL	1
ES APG/HPG80 HEX 50	50 mm <sup>2</sup> Çene - Bakır Papuçlar İçin	1502670000	2.131,00 TL	1
ES APG/HPG80 HEX 70	70 mm <sup>2</sup> Çene - Bakır Papuçlar İçin	1502680000	2.131,00 TL	1
ES APG/HPG80 HEX 95	95 mm <sup>2</sup> Çene - Bakır Papuçlar İçin	1502690000	2.131,00 TL	1
ES APG/HPG80 HEX 120	120 mm <sup>2</sup> Çene - Bakır Papuçlar İçin	1502700000	2.131,00 TL	1
ES APG/HPG80 HEX 150	150 mm <sup>2</sup> Çene - Bakır Papuçlar İçin	1502720000	2.131,00 TL	1
ES APG/HPG80 HEX 185	185 mm <sup>2</sup> Çene - Bakır Papuçlar İçin	1502730000	2.131,00 TL	1
ES APG/HPG80 HEX 240	240 mm <sup>2</sup> Çene - Bakır Papuçlar İçin	1502740000	2.131,00 TL	1
ES APG/HPG80 HEX 300	300 mm <sup>2</sup> Çene - Bakır Papuçlar İçin	1502750000	2.365,00 TL	1
<b>Kablo Bağlı Sıkma</b>				
RT-1	2,5-4,8 mm genişliğinde ve max. 1,6 mm kalınlığında plastik kablo bağları için	1296000000	1.114,00 TL	1
WSM TOOL Otomatik	4,6 mm genişliğinde çelik kablo bağları için	1774470000	1.996,00 TL	1
WSM TOOL Manuel	4,6 mm genişliğinde çelik kablo bağları için	1774480000	9.985,00 TL	1
<b>Hidrolik Punch</b>				
IE-KO-HAT	Hidrolik Punch	1966810000	16.116,00 TL	1
<b>Not:Metrik,PG,Ethernet,HDC,Kablo ve Vida Vb... Çene Aksesuarları için Lütfen Bilgi Alınız.</b>				
<b>Klemens Tornavidaları - İzoleli (VDE) (1000 Volt)</b>				
SDIS 0.4X2.5X75	Düz-(Uç Kalınlık x Uç Uzunluk x Boy Uzunluk)	9008370000	207,25 TL	1
SDIS 0.5X3.0X100	Düz-(Uç Kalınlık x Uç Uzunluk x Boy Uzunluk)	9008380000	217,05 TL	1
SDIS 0.6X3.5X100	Düz-(Uç Kalınlık x Uç Uzunluk x Boy Uzunluk)	9008390000	265,85 TL	1
SDIS 0.8X4.0X100	Düz-(Uç Kalınlık x Uç Uzunluk x Boy Uzunluk)	9008400000	265,85 TL	1
SDIS 1.0X4.5X125	Düz-(Uç Kalınlık x Uç Uzunluk x Boy Uzunluk)	9008910000	275,50 TL	1
SDIS 1.0X5.5X125	Düz-(Uç Kalınlık x Uç Uzunluk x Boy Uzunluk)	9008410000	326,80 TL	1
SDIK PH1	Yıldız-Size 1- Boy uzunluk: 80mm	9008570000	275,50 TL	1

Serinin devamı sayfa 60



SDIS SL 0.6X3.5X100



SDS 0.4X2.0X60



SD Set S2.5-5.5/PH1/2



SWIFTY SET



DMS 3 SET 1



SK WSD-S 1,5-10,0



CROSS-KEY MASTER



KBZ 160

Tip	Açıklama	Sipariş No	Fiyat/Birim	Ambalaj
SDIK PH2	Yıldız-Size 2- Boy uzunluk: 100mm	9008580000	329,20 TL	1
SDI SL S3.5-6.5/PH1/2	İzoleli tornavida seti- 4 Düz/2 Yıldız(İnce Seri)	1274750000	1.303,00 TL	1
SDIS SL 0.6X3.5X100	Düz-(Uç Kalınlık x Uç Uzunluk x Boy Uzunluk)(İnce Seri)	1274660000	190,20 TL	1
SDIS SL 0.8X4.0X100	Düz-(Uç Kalınlık x Uç Uzunluk x Boy Uzunluk)(İnce Seri)	1274670000	224,40 TL	1
SDIS SL 1.0X5.5X125	Düz-(Uç Kalınlık x Uç Uzunluk x Boy Uzunluk)(İnce Seri)	1274680000	270,70 TL	1
SDIS SL 1.2X6.5X150	Düz-(Uç Kalınlık x Uç Uzunluk x Boy Uzunluk)(İnce Seri)	1274690000	353,60 TL	1
SDIK PH1 SL	Yıldız-Size 1- Boy uzunluk: 80mm(İnce Seri)	1274710000	251,10 TL	1
SDIK PH2 SL	Yıldız-Size 2- Boy uzunluk: 100mm(İnce Seri)	1274720000	338,95 TL	1
SDIK PZ1 SL	Yıldız-Size 1- Boy uzunluk: 80mm(İnce Seri)	1274730000	290,25 TL	1
SDIK PZ2 SL	Yıldız-Size 2- Boy uzunluk: 100mm(İnce Seri)	1274740000	402,40 TL	1
SDI SL S3.5-6.5/PZ1/2	Yıldız-Size 1-2- Boy uzunluk:80-100mm(İnce Seri)	1445930000	1.393,00 TL	1

### Klemens Tornavidaları - İzolesiz (VDE)

SDS 0.4X2.0X60	Düz-(Uç Kalınlık x Uç Uzunluk x Boy Uzunluk)	9037160000	136,55 TL	1
SDS 0.4X2.5X75	Düz-(Uç Kalınlık x Uç Uzunluk x Boy Uzunluk)	9009030000	153,60 TL	1
SDS 0.5X3.0X80	Düz-(Uç Kalınlık x Uç Uzunluk x Boy Uzunluk)	9008320000	173,10 TL	1
SDS 0.6X3.5X100	Düz-(Uç Kalınlık x Uç Uzunluk x Boy Uzunluk)	9008330000	173,10 TL	1
SDS 0.6X3.5X200	Düz-(Uç Kalınlık x Uç Uzunluk x Boy Uzunluk)	9010110000	190,20 TL	1
SDS 0.8X4.0X100	Düz-(Uç Kalınlık x Uç Uzunluk x Boy Uzunluk)	9008340000	207,25 TL	1
SDS 0.8X4.5X125	Düz-(Uç Kalınlık x Uç Uzunluk x Boy Uzunluk)	9009020000	207,25 TL	1
SDS 1.0X5.5X150	Düz-(Uç Kalınlık x Uç Uzunluk x Boy Uzunluk)	9008350000	297,45 TL	1
SDS 1.2X6.5X150	Düz-(Uç Kalınlık x Uç Uzunluk x Boy Uzunluk)	9009010000	302,40 TL	1
SDK PH0	Yıldız-Size 0- Boy uzunluk: 60mm	9008470000	173,10 TL	1
SDK PH1	Yıldız-Size 1- Boy uzunluk: 80mm	9008480000	217,05 TL	1
SDK PH2	Yıldız-Size 2- Boy uzunluk: 100mm	9008490000	297,45 TL	1
SDK PH3	Yıldız-Size 3- Boy uzunluk: 150mm	9008500000	465,75 TL	1
SDK PZ1	Yıldız-Size 1- Boy uzunluk: 80mm (Pozidriv tip uç)	9008530000	226,80 TL	1
SDK PZ2	Yıldız-Size 2- Boy uzunluk: 100mm (Pozidriv tip uç)	9008540000	302,40 TL	1
SD Set S2.5-5.5/PH1/2	İzolesiz tornavida seti- 4 Düz/2 Yıldız	9009740000	1.292,00 TL	1
SD Set S2.0-5.5	İzolesiz tornavida seti- 6 Düz	9205560000	1.292,00 TL	1

### Kablo Kesme Aparatı - Tornavida ve Kontrol Kalemi

SWIFTY SET	SD 0,6x3,5x100 tornavida ve kesme aparatı	9006060000	529,00 TL	1
SWIFTY	Kesme aparatı(uç genişliği 3.5mm ye kadar tornavidalar ve tek damarlı max. 1,5mm <sup>2</sup> kesit kablo için)	9006020000	353,60 TL	1
SP 303	Kontrol Kalemi	9006890000	42,55 TL	1

### Şarjlı Tornavida

DMS 3 SET 1	Komple Uçlar, Şarj Ünitesi Kutu İçinde	9007470000	6.933,00 TL	1
DMS 3 SET 2	Set 1+ Yedek Şarj Cihazı	9007480000	7.538,00 TL	1
Bit-Box WI DMS 3	Uç Seti	9024970000	529,00 TL	1

### Allen Anahtar Setleri

SK WSD-S 1,5-10,0	Size AF 1.5-2-2.5-3-4-5-6-8-10	9008850000	688,00 TL	1
SKS 2,0-8,0	Size Allen 2-2.5-3-4-5-6-8	9008860000	456,00 TL	1
SKS 2,0-8,0 MR	Size Torx 2-2.5-3-4-5-6-8	9008870000	525,00 TL	1
TH-S 9-40	Size Torx 9-10-15-20-25-27-30-40	9008880000	588,00 TL	1

### Pano Anahtar Setleri

CROSS-KEY MASTER	1X7 mm Düz/ PH 2 Yıldız/ 5,7,8 mm Kare/ 9 mm Üçgen/ 4 mm Allen	9918150000	363,35 TL	1
CROSS-KEY UNIVERSAL	1X7 mm Düz/ PH 2 Yıldız/ 5,7,8 mm Kare/ 9 mm Yuvarlak/ 4 mm Allen	9918130000	363,35 TL	1
CROSS-KEY UNIVERSAL S	1X7 mm Düz/ PH 2 Yıldız/ 5,8 mm Kare/ 9 mm Üçgen/ 4 mm Yuvarlak	9918140000	356,05 TL	1

### Pense VDE İzoleli (1000 Volt)

KBZ 160	160 mm / 60 HRC	9046280000	514,00 TL	1
KBZ 180	180 mm / 60 HRC	9046290000	554,00 TL	1
KBZ 200	200 mm / 60 HRC	9046300000	597,00 TL	1
KBZI 200	200 mm / 60 HRC / Telefon Tesisatları İçin	9046430000	659,00 TL	1



KSE 160



FRZ SG 160



VT DIGI PRO



MG KIT CA 600



CRIMP-SET PZ 6 ROTO L



TOOL SET IE-POF

Tip	Açıklama	Sipariş No	Fiyat/Birim	Ambalaj
<b>Yan Keski VDE İzoleli (1000 Volt)</b>				
KSE 160	160 mm	9046410000	659,00 TL	1
KSE 200	200 mm	9046420000	663,00 TL	1
SE TOP	160 mm	9046340000	806,00 TL	1
SE HD 140	140 mm	9046310000	514,00 TL	1
SE HD 160	160 mm	9046320000	554,00 TL	1
SE HD 180	180 mm	9046330000	624,00 TL	1
<b>Kargaburun VDE İzoleli (1000 Volt)</b>				
FRZ SG 160	160 mm / 45 / 60 HRC, 45 derece eğik uçlu	9046390000	590,00 TL	1
FRZ SG 200	200 mm / 45 / 60 HRC, 45 derece eğik uçlu	9046400000	597,00 TL	1
FRZ S 160	160 mm / 60 HRC	9046370000	519,00 TL	1
FRZ S 200	200 mm / 60 HRC	9046380000	529,00 TL	1
FZ 160	160 mm / Düz Uç	9046350000	477,90 TL	1
RZ 160	160 mm / Yuvarlak Uç	9046360000	477,90 TL	1
<b>Test ve Ölçü Aletleri (Faz Kalemi Tipi)</b>				
* VT LCL	Temasız kablo test cihazı 12 - 1000VAC	2436670000	300,20 TL	1
VT DIGI PRO	1 - 1000 V AC/DC, LCD ekran, Faz Sırası Göstegesi, buton ile 30mA RCD tetikleme, tek kutup faz testi, ışıklı ölçme problemleri	9918870000	2.723,00 TL	1
VT COMBI PRO	6 - 690 V AC/DC, LED skala, Faz Sırası Göstegesi, tek kutup faz testi, ışıklı ölçme problemleri	9918860000	1.186,00 TL	1
VT MASTER	12 - 690 V AC/DC, LED skala(12, 24, 50, 120, 230, 400, 690 V)	9918880000	1.074,00 TL	1
VT	12 - 690 V AC/DC, LED skala(12, 50, 120, 230, 400, 690 V)	9918950000	386,95 TL	1
<b>Test ve Ölçü Aletleri</b>				
TEMPHASER	0.2 - 600 VAC/DC, 2,000 MΩ kadar direnç, 20 µF - 20 mF arası kapasite, 10 Hz - 40 kHz arası frekans, diyet ve faz sırası testi	9427300000	2.048,00 TL	1
MULTIMETER 125S	0.32 - 600 VAC/DC, 30 MΩ kadar direnç, Diyet Testi	9425830000	1.527,00 TL	1
MG KIT CA 600	0.2 - 600 V AC/DC, 0 - 600 A AC/DC amp., 2,000 MΩ kadar direnç, 20 µF - 20 mF arası kapasite, 10 Hz - 40 kHz arası frekans, diyet ve faz sırası testi	9427460000	4.846,00 TL	1
MULTIMETER 1037	0.2 - 1,000 V DC, 0.2 - 750 V AC, 200A AC ye kadar pens amp. Adaptörü, 200kΩ a kadar direnç ve 20 µF a kadar kapasite ölçümü	9423580000	3.797,00 TL	1
MULTIMETER C 2606	0.2 - 1,000 V DC, 0.2 - 750 V AC, 1000 A AC/DC ye kadar amp., 40 MΩ kadar direnç, 4 nF - 40 µF kapasite, 0.1 - 400 kHz frekans, diyet testi	9427370000	4.658,00 TL	1
LAN USB TESTER	LAN ve USB bağlantıları için network kablo test aleti, LED skala/ RJ45, USB A, USB B bağlantı tipi/max 1000 mt	9205400000	1.415,00 TL	1
THERMOMETER 610 LC	-20°C...260°C derece lazer sıcaklık ölçümü	9427520000	3.522,00 TL	1
<b>El Aletleri Seti</b>				
CRIMP-SET PZ 6 ROTO L	PZ 6 ROTO, STRIPAX ve 7 Bölme Yüksük	9028680000	4.696,00 TL	1
CRIMP-SET PZ 6/5	PZ 6/5, STRIPAX ve 7 Bölme Yüksük	9028740000	5.282,00 TL	1
CRIMP-SET PZ 16	PZ 16. STRIPAX 16 ve 6 Bölme Yüksük	9025850000	5.282,00 TL	1
Crimpset PZ / CTI	CTI 6, STRIPAX ve 19 Bölme Pabuç	9202610000	9.985,00 TL	1
Crimp-Set Kontakte	25 Bölmeli Yüksük ve Pabuç Kutusu (Yüksük, Pabuç dahil)	9202640000	3.522,00 TL	1
H-LEERBOX 5	5 Bölmeli, Yuvarlak Tip Boş Yüksük Kutusu	9025940000	175,60 TL	1
Tool Set Combi Check	KT 8, Stripax, PZ 6 Roto, Combi Check ve Screwdriverset	9201650000	5.417,00 TL	1
PROFI SET	KT 8, Stripax, Screwdriverset ve SK WSD-S	9918840000	2.887,00 TL	1
* TOOL SET IE-POF	Multi-Stripax IE-POF, HTX-IE-POF	1208930000	33.507,00 TL	1





P BAG SET 1



P BAG XL SET 10



Pro Case Insta

Tip	Açıklama	Sipariş No	Fiyat/Birim	Ambalaj
<b>Takım Çantaları</b>				
<b>P BAG SET 1</b>				
P BAG SET 1	6 Parça El Tipi Takım Çantası	2561430000	5.824,00 TL	1
STRIPAX Ultimate	Halogen Free Kablolar için 0,25...6 mm2 kesitler için	-	-	1
PZ 10 HEX	0,14...10 mm2 kesit aralığında tek yuvada hexagonal sıkma	-	-	1
SDIS 0,6X3,5X100	Düz (Uç kalınlık x Uç Uzunluk x Boy Uzunluk)	-	-	1
SKS 2,0-8,0	Size Allen 2-2.5-3-4-5-6-8	-	-	1
KBZ 160	160 mm / 60 HRC	-	-	1
P BAG	Boş küçük tip el çantası	-	-	1
<b>P BAG XL SET 10</b>				
P BAG XL SET 10	10 Parça El Tipi Takım Çantası	2602200000	7.616,00 TL	1
P BAG BIG	Boş Büyük Tip El Çantası	-	-	1
KT 8	8 mm max. Çap/Örgü kesit:16mm <sup>2</sup> /Çok Damarlı kesit:16mm <sup>2</sup> /Tek Damarlı Kesit:16mm <sup>2</sup>	-	-	1
STRIPAX 16	6...16mm <sup>2</sup> arası kesit PVC kablolar için	-	-	1
VT COMBI PRO	6 - 690 V AC/DC, LED skala, Faz Sırası Göstegesı, tek kutup faz testi, ışıklı ölçme problemleri	-	-	1
AM 25	6...25mm çap aralığına sahip PVC kablolar için	-	-	1
PZ 16	6...16mm <sup>2</sup> kesit aralığında 3 farklı yuvada W tipi sıkma	-	-	1
SDIK PH1 SL	Yıldız-Size 1- Boy uzunluk: 80mm(İnce Seri)	-	-	1
SDIK PH2 SL	Yıldız-Size 2- Boy uzunluk: 100mm(İnce Seri)	-	-	1
SDIS SL 0.6X3.5X100	Düz-(Uç Kalınlık x Uç Uzunluk x Boy Uzunluk)(İnce Seri)	-	-	1
SDIS SL 0.8X4.0X100	Düz-(Uç Kalınlık x Uç Uzunluk x Boy Uzunluk)(İnce Seri)	-	-	1
<b>Pro Case Insta</b>				
Pro Case Insta	18 Parça Takım Çantası	9203160000	16.143,00 TL	1
AM 25	6...25 mm çap aralığına sahip kabloları soyma	-	-	1
KT 8	16mm <sup>2</sup> kesite kadar olan kabloları kesme	-	-	1
STRIPAX	0.08...10mm <sup>2</sup> kesit aralığına sahip kablo soyma ve kesme	-	-	1
PZ 6 Roto	0,14...6mm <sup>2</sup> kesit aralığında olan kablolar için yüksek sıkma(tek çene)	-	-	1
H-BOX 0,5-2,5QMM DIN	0.5...2.5 mm <sup>2</sup> kesit aralığında yükseklerinde içinde bulunduğu yüksek kutusu	-	-	1
AM 12	0.5...12.5mm çap aralığına sahip kabloları soyma	-	-	1
COMBI CHECK	6-690 V AC/DC,LED skala,Faz Sırası Göstegesı, tek kutup faz testi,ışıklı ölçme problemleri	-	-	1
FLEXIMET 5 M	Weidmüller çelik metre	-	-	1
Pro Case leer	BEZ ÇANTA	-	-	1
STRIPPER ROUND TOP	8...13mm çap aralığında çok damarlı kabloları çift kademeli soyma	-	-	1
FRZ S 160	160 mm / 60 HRC Kargaburun	-	-	1
SE HD 180	Sert kablolar için diogonal kesme pensesi	-	-	1
KBZ 180	180 mm / 60 HRC pense	-	-	1
CROSS-KEY UNIVERSAL	pano anahtarı	-	-	1
SK WSD-S 1,5-10,0	9 parçadan oluşan alyan anahtarı seti	-	-	1
SDI Set S2.5-5.5/PH1/2	6 parçadan oluşan izoleli tornavida seti	-	-	1
SKS 2,0-8,0 MR	7 parçadan oluşan alyan anahtarı	-	-	1
PACK HEXA 8-13	lokma anahtar takımı	-	-	1



Pro Case Premium

Tip	Açıklama	Sipariş No	Fiyat/Birim	Ambalaj
<b>Pro Case Premium</b>				
Pro Case Premium	25 Parça Takım Çantası	9202460000	27.005,00 TL	1
AM 25	6...25 mm çap aralığına sahip kabloları soyma	-	-	1
KT 8	16mm <sup>2</sup> kesite kadar olan kabloları kesme	-	-	1
STRIPAX	0.08...10mm <sup>2</sup> kesit aralığına sahip kablo soyma ve kesme	-	-	1
PZ 6 Roto	0,14...6mm <sup>2</sup> kesit aralığında olan kablolar için yüksük sıkma (tek çene)	-	-	1
H-BOX 0,5-2,5QMM DIN	0.5...2.5 mm <sup>2</sup> kesit aralığında yüksüklerinde içinde bulunduğu yüksük kutusu	-	-	1
AM 12	0.5...12.5mm çap aralığına sahip kabloları soyma	-	-	1
DIGI CHECK	0,3 - 690 V AC/DC, LCD ekran, tek kutup faz testi, ışıklı ölçme problemleri	-	-	1
COMBI CHECK	6-690 V AC/DC, LED skala, Faz Sırası Göstegesi, tek kutup faz testi, ışıklı ölçme problemleri	-	-	1
Pro Case leer	BEZ ÇANTA	-	-	1
STRIPPER ROUND TOP	8...13mm çap aralığında çok damarlı kabloları çift kademeli soyma	-	-	1
FRZ S 160	160 mm / 60 HRC Kargaburun	-	-	1
SE HD 180	Sert kablolar için diogonal kesme pensesi	-	-	1
KBZ 180	180 mm / 60 HRC pense	-	-	1
RZ 160	160 mm / Yuvarlak Uç	-	-	1
AIZ 160	5mm çapa kadar yan keski	-	-	1
CROSS-KEY UNIVERSAL	pano anahtarı	-	-	1
SWIFTY SET	SD 0,6x3,5x100 tornavida ve kesme aparatı	-	-	1
SK WSD-S 1,5-10,0	9 parçadan oluşan alyan anahtarı seti	-	-	1
SD Set S2.5-5.5/PH1/2	6 parçadan oluşan izolesiz tornavida seti	-	-	1
SDI Set S2.5-5.5/PH1/2	6 parçadan oluşan izoleli tornavida seti	-	-	1
Bit-Box WI DMS 3	9 parça tornavida uç seti	-	-	1
SKS 2,0-8,0 MR	7 parçadan oluşan alyan anahtarı	-	-	1
TESTBOY 20	Işıklı kontrol test kalem	-	-	1
WK S 0,5x3,0	0.5 x 3 boyutunda değiştirilebilir	-	-	1
DMS MANUELL 0,5-1,7	0.5-1.7 Nm Tork ayarlı Tornavida	-	-	1

Tip	Açıklama	Sipariş No	Fiyat/Birim	Ambalaj
<b>Top Case Insta</b>				
TOP CASE INSTA	18 Parça Takım Çantası	1345310000	21.840,00 TL	1
AM 25	6...25 mm çap aralığına sahip kabloları soyma	-	-	1
KT 8	16mm <sup>2</sup> kesite kadar olan kabloları kesme	-	-	1
STRIPAX	0.08...10mm <sup>2</sup> kesit aralığına sahip kablo soyma ve kesme	-	-	1
PZ 6 Roto	0,14...6mm <sup>2</sup> kesit aralığında olan kablolar için yüksük sıkma (tek çene)	-	-	1
H-BOX 0,5-2,5QMM DIN	0.5...2.5 mm <sup>2</sup> kesit aralığında yüksüklerinde içinde bulunduğu yüksük kutusu	-	-	1
AM 12	0.5...12.5mm çap aralığına sahip kabloları soyma	-	-	1
COMBI CHECK	6-690 V AC/DC, LED skala, Faz Sırası Göstegesi, tek kutup faz testi, ışıklı ölçme problemleri	-	-	1
PLASTIC CASE	PLASTİK SERT KAPAK ÇANTA	-	-	1
STRIPPER ROUND TOP	8...13mm çap aralığında çok damarlı kabloları çift kademeli soyma	-	-	1
FRZ S 160	160 mm / 60 HRC Kargaburun	-	-	1
SE HD 180	Sert kablolar için diogonal kesme pensesi	-	-	1
KBZ 180	180 mm / 60 HRC pense	-	-	1
CROSS-KEY UNIVERSAL	pano anahtarı	-	-	1
SK WSD-S 1,5-10,0	9 parçadan oluşan alyan anahtarı seti	-	-	1
SDI Set S2.5-5.5/PH1/2	6 parçadan oluşan izoleli tornavida seti	-	-	1
SKS 2,0-8,0 MR	7 parçadan oluşan alyan anahtarı	-	-	1
Pack HEXA P-13	lokma anahtar takımı	-	-	1
Fleximet M5	Weidmüller çelik metre	-	-	1



TOP CASE INSTA

## El Aletleri



TOP CASE PREMIUM



TOP CASE 16



P BAG



Pro Case leer



CUTFIX 8



CA 100 DUO



Tool Chest Empty



TC INL BIG 1

Tip	Açıklama	Sipariş No	Fiyat/Birim	Ambalaj
<b>Top Case Premium</b>				
TOP CASE PREMIUM	24 Parça Takım Çantası	1345320000	27.440,00 TL	1
AM 25	6...25 mm çap aralığına sahip kabloları soyma		-	1
KT 8	16mm <sup>2</sup> kesite kadar olan kabloları kesme		-	1
STRIPAX	0.08...10mm <sup>2</sup> kesit aralığına sahip kablo soyma ve kesme		-	1
PZ 6 Roto	0,14...6mm <sup>2</sup> kesit aralığında olan kablolar için yüksük sıkma (tek çene)		-	1
H-BOX 0,5-2,5QMM DIN	0.5...2.5 mm <sup>2</sup> kesit aralığında yüksüklerinde içinde bulunduğu yüksük kutusu		-	1
AM 12	0.5...12.5mm çap aralığına sahip kabloları soyma		-	1
DIGI CHECK	0,3-690 V AC/DC, LCD ekran, tek kutup faz testi, ışıklı ölçme problemleri		-	1
COMBI CHECK	6-690 V AC/DC, LED skala, Faz Sırası Göstergesi, tek kutup faz testi, ışıklı ölçme problemleri		-	1
PLASTIC CASE	PLASTİK SERT KAPAK ÇANTA		-	1
STRIPPER ROUND TOP	8...13mm çap aralığında çok damarlı kabloları çift kademeli soyma		-	1
FRZ S 160	160 mm / 60 HRC Kargaburun		-	1
SE HD 180	Sert kablolar için diogonal kesme pensesi		-	1
KBZ 180	180 mm / 60 HRC pense		-	1
RZ 160	160 mm / Yuvarlak Uç		-	1
CROSS-KEY UNIVERSAL	pano anahtarı		-	1
SWIFTY SET	SD 0,6x3,5x100 tornavida ve kesme aparatı		-	1
SK WSD-S 1,5-10,0	9 parçadan oluşan alyan anahtarı seti		-	1
SD Set S2.5-5.5/PH1/2	6 parçadan oluşan izolesiz tornavida seti		-	1
SDI Set S2.5-5.5/PH1/2	6 parçadan oluşan izoleli tornavida seti		-	1
Bit-Box WI DMS 3	9 parça tornavida uç seti		-	1
SKS 2,0-8,0 MR	7 parçadan oluşan alyan anahtarı		-	1
WK S 0,5x3,0	0.5 x 3 boyutunda değiştirilebilir		-	1
DMS MANUELL 0,5-1,7	0.5-1.7 Nm Tork ayarlı Tornavida		-	1
AM 16	6...17 mm çap aralığına sahip PVC kablolar için		-	1

Tip	Açıklama	Sipariş No	Fiyat/Birim	Ambalaj
<b>Top Case 16</b>				
* TOP CASE 16	16 Parça Takım Çantası	2602310000	21.000,00 TL	1

### Boş Takım Çantaları

P BAG	Boş Küçük Tip El Çantası	2548180000	425,60 TL	1
P BAG BIG	Boş Büyük Tip El Çantası	2576620000	538,00 TL	1
Pro Case leer	Boş Takım Çantası Bez	9202470000	2.072,00 TL	1
TOP CASE	Boş Takım Çantası Metal Çerçeve	1345330000	5.376,00 TL	1

### Otomatik Makinalar

CUTFIX 8	0,14...10mm <sup>2</sup> flexible kablo kesme	9023100000	6.967,00 €	1
POWERSTRIPPER 6,0	0,14-6mm <sup>2</sup> güçlü soyma	9028510000	3.795,00 €	1
POWERSTRIPPER 16,0	2,5-16mm <sup>2</sup> güçlü soyma	9028480000	5.417,00 €	1
POWERSTRIPPER ao 2,5-20	0,5-2,5mm <sup>2</sup> otomatik soyma	9027270000	7.038,00 €	1
POWERSTRIPPER ao 16-20	4-16mm <sup>2</sup> otomatik soyma	9027290000	7.521,00 €	1
CRIMPFIX R	Pnömatik soyma ve şerit yüksük sıkma	9028500000	19.680,00 €	1
CRIMPFIX L	0,5-2,5mm <sup>2</sup> kablo soyma ve dökme yüksük sıkma, Pinomatik, 8 mm yüksük uç uzunluğu, 14mm yüksük uzunluğu için	9028530000	24.000,00 €	1
CRIMPFIX LS	0,5-2,5mm <sup>2</sup> kablo soyma ve dökme yüksük sıkma, Pinomatik, 6/8/10 mm yüksük uç uzunluğu, 12/14/16 mm yüksük uzunluğu için	9028540000	28.000,00 €	1
CRIMPFIX LZ	Çift girişli dökme yüksük sıkma	9027310000	28.360,00 €	1
CRIMPFIX R VARIO	Kablo soyma ve çoklu şerit yüksük sıkma	2580000000	29.167,00 €	1
* CA 100 DUO	0-10mm <sup>2</sup> kablo soyma ve çoklu şerit yüksük sıkma	2740900000	60.000,00 €	1

**Not:** Otomatik Kesme, Soyma ve Yüksük Sıkma Makinaları Hakkında Teknik ve Fiyat Bilgisi için Bölge Satış Temsilcimizle iletişime geçiniz.

Tip	Açıklama	Genişlik/Derinlik Yükseklik (mm)	Sipariş No	Fiyat/Birim	Ambalaj
<b>Takım Çantaları</b>					
<b>Çekmeceli Takım Dolapları</b>					
Tool Chest Empty	Boş dolap	894 / 525 / 928	2683640000	32.816,00 TL	1
<b>Çekmeceli Takım Dolapları</b>					
TC INL BIG 1	Dolu çekmece içi		2683720000	26.880,00 TL	1

## Kutular

Weidmüller'in çok geniş bir ürün yelpazesini oluşturan kutular, elektrik bağlantılarını ve komponentlerini çok çeşitli şartlar ve zorlu çevre koşullarından korumak için tasarlandı ve bu şartlarda test edilerek kullanıma sunuldu.

### Klippon K Alüminyum Kutular

K serisi alüminyum kutuların birçok uygulama alanı vardır. K serisi kutuların içlerine klemensler, şalterler, butonlar, göstergeler ve elektronik komponentler montaj edilebilir.

#### Özellikleri:

- 2 tip olarak 19 ayrı ölçü
- Paslanmaz çelik kapak vidaları
- Montaj delikleri kutu içinden izoleli
- Raylar ve diğer montaj plakaları için açılmış vida dişleri
- IP 66, IP 67 ve IP 68 koruma sınıfı
- Yağmur, erimiş kar ve çığ gibi koşullarda kullanılabilir.

Endüstride ve ulaşımda kullanılabilir. Ayrıca ATEX standartlarına uygun olduğundan patlama tehlikesi olan ortamlarda kullanılabilir.

### Klippon POK Polyester Kutular

Cam elyafı içeren kuvvetlendirilmiş POK serisi polyester kutular hem iç hem de dış ortamlarda kullanılmaya uygundur.

#### Özellikleri:

- 2 tip /17 ölçü
- Paslanmaz çelik kapak vidaları
- Montaj delikleri kutu içinden izole
- Raylar ve diğer montaj plakaları için açılmış vida delikleri
- IP 66 Koruma sınıfı

Bu kutular özellikle paslanma ve fiziksel darbelere karşı, yüksek koruma sınıfı gerektiren uygulamalarda tercih edilirler.





KLIPPON K02



KLIPPON POK 080806



KLIPPON POK 081606



MPC 07/12/07 7035



MPC 12/12/07 7035



MPC 20/20/13 7035



FPC 20/40/13 7035

Tip	Boy x En x Derinlik (mm)	Ağırlık	Sipariş No	Fiyat/Birim	Ambalaj
<b>Alüminyum Döküm Gövde- Klippon® K</b>					
KLIPPON K0	45 x 50 x 30	65 g	0573200000	8,70 €	10
KLIPPON K01	64 x 58 x 34	120 g	1565240000	17,40 €	10
KLIPPON K02	64 x 98 x 34	200 g	1565250000	20,10 €	6
KLIPPON K1	70 x 70 x 45	220 g	0342000000	16,05 €	10
KLIPPON K11	80 x 75 x 57	280 g	0573300000	21,45 €	10
KLIPPON K2	70 x 100 x 45	280 g	0342100000	25,40 €	10
KLIPPON K21	80 x 125 x 57	400 g	0573400000	20,00 €	5
KLIPPON K3	70 x 165 x 45	400 g	0342200000	21,45 €	5
KLIPPON K31	80 x 175 x 57	520 g	0573500000	25,40 €	5
KLIPPON K32	80 x 250 x 55	710 g	1565260000	40,15 €	1
KLIPPON K4	82 x 130 x 72	620 g	0342300000	28,15 €	1
KLIPPON K41	120 x 122 x 81	840 g	1565270000	45,00 €	1
KLIPPON K5	130 x 170 x 90	1540 g	0342400000	56,20 €	1
KLIPPON K51	120 x 220 x 81	1280 g	1565280000	56,00 €	1
KLIPPON K52	160 x 160 x 91	1480 g	1565290000	61,60 €	1
KLIPPON K6	160 x 200 x 100	2000 g	0342500000	62,90 €	1
KLIPPON K61	160 x 260 x 91	2060 g	0573600000	77,65 €	1
KLIPPON K7	160 x 350 x 100	2870 g	0342600000	93,70 €	1
KLIPPON K71	230 x 280 x 111	2925 g	0573700000	110,00 €	1
<b>Polyester - Klippon® POK</b>					
KLIPPON POK 080806	75 x 80 x 55	230 g	1305810000	27,50 €	1
KLIPPON POK 081106	75 x 110 x 55	295 g	1305820000	32,00 €	1
KLIPPON POK 081606	75 x 160 x 55	405 g	1305830000	32,70 €	1
KLIPPON POK 081906	75 x 190 x 55	450 g	1305840000	37,95 €	1
KLIPPON POK 082306	75 x 230 x 55	575 g	1305850000	40,60 €	1
KLIPPON POK 121209	120 x 122 x 90	750 g	1305870000	48,00 €	1
KLIPPON POK 122209	120 x 220 x 90	1060 g	1305880000	49,70 €	1
KLIPPON POK 161609	160 x 160 x 90	1290 g	1305890000	58,00 €	1
KLIPPON POK 162609	160 x 260 x 90	1710 g	1305900000	88,00 €	1
KLIPPON POK 163609	160 x 360 x 90	2150 g	1305910000	90,30 €	1
KLIPPON POK 165609	160 x 560 x 90	3185 g	1305920000	149,00 €	1
KLIPPON POK 252512	250 x 255 x 120	2650 g	1305930000	117,00 €	1
KLIPPON POK 254012	250 x 400 x 120	3650 g	1305940000	143,00 €	1
KLIPPON POK 256012	250 x 600 x 120	5235 g	1305950000	204,00 €	1
KLIPPON POK 404012	405 x 400 x 120	5580 g	1305970000	173,00 €	1
KLIPPON POK 252516	250 x 255 x 160	3275 g	1305980000	149,00 €	1
KLIPPON POK 254016	250 x 400 x 160	4800 g	1305990000	196,00 €	1
<b>Polikarbonat - Klippon® MPC</b>					
MPC 07/12/07 7035	125 x 75 x 75	209 g	9535170000	17,50 €	1
MPC 07/12/12 7035	125 x 75 x 125	300 g	9535210000	20,00 €	1
MPC 12/12/07 7035	125 x 125 x 75	283 g	9535230000	19,00 €	1
MPC 12/17/07 7035	175 x 125 x 75	381 g	9535290000	23,80 €	1
MPC 17/25/10 7035	250 x 175 x 100	743 g	9535470000	48,65 €	1
<b>Polikarbonat - Klippon® FPC</b>					
FPC 20/20/13 7035	200 x 200 x 130	1039 g	9535690000	53,55 €	1
FPC 20/30/13 7035	200 x 300 x 130	1349 g	9535710000	69,00 €	1
FPC 20/40/13 7035	200 x 400 x 130	1674 g	9535730000	93,00 €	1
FPC 30/30/13 7035	300 x 300 x 130	1738 g	9535750000	95,15 €	1
FPC 30/40/13 7035	300 x 400 x 130	2199 g	9535770000	113,00 €	1
FPC 40/60/13 7035	400 x 600 x 130	3964 g	9535810000	215,00 €	1



Klippon STB



Klippon TB MH



Klippon TB QL



KTB QL 303020 SE4



KTB MH 221513 S4E1



KTB MH 262620 S4E1

Paslanmaz Çelik - Seri	Klippon TB MH	Klippon TB QL	Klippon STB		
	Asma Kilitli	Dahili Kilitli	Sabit Vidalı		
Malzeme	Paslanmaz Çelik	Paslanmaz Çelik	Paslanmaz Çelik		
Malzeme Özellikleri	"Paslanmaz Çelik 1.4404 (316L) 1.5 mm"	"Paslanmaz Çelik 1.4404 (316L) 1.5 mm"	"Paslanmaz Çelik 1.4404 (316L) 1.6 mm"	"Toz boya kaplı çelik sac 1.0330"	
Su Dayanımı	çok iyi	çok iyi	çok iyi	iyi	
UV Dayanımı	çok iyi	çok iyi	çok iyi	toz boya kaplı	
Halojen Free	x	x	x	x	
Yüzey	Elektroliz yolu ile parlatılmış	Elektroliz yolu ile parlatılmış	"Elektroliz yolu ile parlatılmış Ayna parlaklığı"		
Kullanım Amacı	Patlayıcı ortamlar, off-shore, yağ ve gaz endüstrisi, kimya endüstrisi, proses endüstrisi	Patlayıcı ortamlar, off-shore, yağ ve gaz en- düstrisi, kimya endüstrisi, proses endüstrisi			
Boyutlar					
LXWXH (min) mm	229x152x133	229x152x133	120x120x80		
LXWXH (max) mm	987x740x200	987x740x200	250x400x130		
Geometri	3 adet standart derinlik	3 adet standart derinlik	5 adet standart derinlik		
Özel Karakteristikler			EX Tipi	Endüstriyel Tipi	
Sıcaklık Aralığı	-60 °C...+135 °C	-60 °C...135 °C	-60 °C...100 °C	-60 °C...120 °C	
Darbe Dayanımı	"10 J endüstri Uygulamaları 7 J ATEX Uygulamalar"	"10 J endüstri Uygulamaları 7 J ATEX Uygulamalar"	7J	10J	
IP Koruma Sınıfı					
Uygunluk					
ATEX	x	x	x		
- EN60079-7 Increased safety	x	x	x		
- EN60079-11 Intrinsic safety	x	x	x		
IECEX	x	x			
- IEC60079-7 Increased safety	x	x			
- IEC60079-11 Intrinsic safety	x	x			
GOST Ex	x	x			
GOST	*	*			
cULus	x	x	x	*	
UL					
German Lloyd	x	x	x		
Lloyds Register			x	*	
Russian Maritime Register	x	x			
CCOE	*				
Tip	Boy x En x Derinlik (mm)	Koruma Sınıfı	Sipariş No	Fiyat/Birim	Ambalaj
Paslanmaz Çelik - Yeni Seri					
Paslanmaz Çelik - Klippon® TB MH - Multi Hinge					
KTB MH 221513 S4E1	229 x 152 x 133	IP66, IP67	1194560000	484,00 €	1
KTB MH 262615 S4E1	260 x 260 x 150	IP66, IP67	1194610000	571,00 €	1
KTB MH 262620 S4E1	260 x 260 x 200	IP66, IP67	1194660000	633,00 €	1
KTB MH 303015 S4E1	306 x 306 x 150	IP66, IP67	1194710000	610,00 €	1
KTB MH 303020 S4E1	306 x 306 x 200	IP66, IP67	1194760000	850,00 €	1
KTB MH 352615 S4E1	350 x 260 x 150	IP66, IP67	1194810000	618,00 €	1
KTB MH 352620 S4E1	350 x 260 x 200	IP66, IP67	1194860000	850,00 €	1
KTB MH 403015 S4E1	400 x 300 x 150	IP66, IP67	1194910000	674,00 €	1
KTB MH 403020 S4E1	400 x 300 x 200	IP66, IP67	1194960000	764,00 €	1
KTB MH 453815 S4E1	458 x 382 x 150	IP66, IP67	1195010000	793,00 €	1
KTB MH 453820 S4E1	458 x 382 x 200	IP66, IP67	1195060000	1.000,00 €	1
KTB MH 484815 S4E1	480 x 480 x 150	IP66, IP67	1195110000	916,00 €	1

Serinin devamı sayfa 68



KTB QL 221513 S4E1



KTB QL 262620 S4E1



KLIPPON STB 1 SS

Tip	Boy x En x Derinlik (mm)	Koruma Sınıfı	Sipariş No	Fiyat/Birim	Ambalaj
KTB MH 484820 S4E1	480 x 480 x 200	IP66, IP67	1195160000	1.220,00 €	1
KTB MH 553515 S4E1	550 x 350 x 150	IP66, IP67	1195210000	982,00 €	1
KTB MH 553520 S4E1	550 x 350 x 200	IP66, IP67	1195260000	982,00 €	1
KTB MH 624515 S4E1	620 x 450 x 150	IP66, IP67	1195310000	1.204,00 €	1
KTB MH 624520 S4E1	620 x 450 x 200	IP66, IP67	1195360000	1.282,00 €	1
KTB MH 765015 S4E1	762 x 568 x 150	IP66, IP67	1195410000	1.380,00 €	1
KTB MH 765020 S4E1	762 x 568 x 200	IP66, IP67	1195460000	1.619,00 €	1
KTB MH 916115 S4E1	914 x 610 x 150	IP66, IP67	1195510000	1.877,00 €	1
KTB MH 916120 S4E1	914 x 610 x 200	IP66, IP67	1195560000	1.914,00 €	1
KTB MH 987420 S4E1	980 x 740 x 200	IP66, IP67	1195610000	2.108,00 €	1

#### Paslanmaz Çelik - Klippon® TB QL - Quarter Lock

KTB QL 221513 S4E1	229 x 152 x 133	IP66	1199860000	542,00 €	1
KTB QL 262615 S4E1	260 x 260 x 150	IP66	1199910000	617,00 €	1
KTB QL 262620 S4E1	260 x 260 x 200	IP66	1199960000	657,00 €	1
KTB QL 303015 S4E1	306 x 306 x 150	IP66	1200020000	640,00 €	1
KTB QL 303020 S4E1	306 x 306 x 200	IP66	1200070000	684,00 €	1
KTB QL 352615 S4E1	350 x 260 x 150	IP66	1200120000	715,00 €	1
KTB QL 352620 S4E1	350 x 260 x 200	IP66	1200170000	755,00 €	1
KTB QL 403015 S4E1	400 x 300 x 150	IP66	1200230000	804,00 €	1
KTB QL 403020 S4E1	400 x 300 x 200	IP66	1200280000	846,00 €	1
KTB QL 453815 S4E1	458 x 382 x 150	IP66	1200340000	813,00 €	1
KTB QL 453820 S4E1	458 x 382 x 200	IP66	1200390000	850,00 €	1
KTB QL 484815 S4E1	480 x 480 x 150	IP66	1200450000	930,00 €	1
KTB QL 484820 S4E1	480 x 480 x 200	IP66	1200510000	1.064,00 €	1
KTB QL 553515 S4E1	550 x 350 x 150	IP66	1200560000	1.076,00 €	1
KTB QL 553520 S4E1	550 x 350 x 200	IP66	1200620000	1.076,00 €	1
KTB QL 624515 S4E1	620 x 450 x 150	IP66	1200670000	1.225,00 €	1
KTB QL 624520 S4E1	620 x 450 x 200	IP66	1200730000	1.281,00 €	1
KTB QL 765015 S4E1	762 x 568 x 150	IP66	1200780000	1.380,00 €	1
KTB QL 765020 S4E1	762 x 568 x 200	IP66	1200840000	1.619,00 €	1
KTB QL 916115 S4E1	914 x 610 x 150	IP66	1200890000	1.878,00 €	1
KTB QL 916120 S4E1	914 x 610 x 200	IP66	1200950000	1.915,00 €	1
KTB QL 987420 S4E1	980 x 740 x 200	IP66	1201010000	2.108,00 €	1

#### Paslanmaz Çelik - Klippon® STB

KLIPPON STB 1 SS	120 x 120 x 80	IP66	1002690000	180,00 €	1
KLIPPON STB 1.1 SS	150 x 120 x 80	IP66	1002750000	189,00 €	1
KLIPPON STB 2 SS	150 x 150 x 90	IP66	1002740000	197,00 €	1
KLIPPON STB 2.1 SS	190 x 150 x 90	IP66	1002730000	247,00 €	1
KLIPPON STB 3 SS	190 x 190 x 100	IP66	1002720000	259,00 €	1
KLIPPON STB 4 SS	250 x 250 x 120	IP66	1002710000	326,00 €	1
KLIPPON STB 5 SS	160 x 380 x 120	IP66	1002700000	405,00 €	1
KLIPPON STB 6 SS	250 x 400 x 130	IP66	1002760000	479,00 €	1

Tip	Renk	Sipariş No	Fiyat/Birim	Ambalaj
<b>Kablo Bağlantı Yüksükleri</b>				
<b>İzoleli İletken Yüksükleri</b>				
H0,5/14 OR	Turuncu	0690700000	0,147 TL	500
H0,75/14 W	Beyaz	0462900000	0,147 TL	500
H1,0/14 GE	Sarı	0463000000	0,147 TL	500
H1,5/14 R	Kırmızı	0463100000	0,147 TL	500
H1,5/16 R	Kırmızı	0635100000	0,269 TL	500
H1,5/24 R	Kırmızı	0565600000	0,355 TL	500
H2,5/14S BL	Mavi	1333100000	0,208 TL	500
H2,5/19D BL	Mavi	9019170000	0,336 TL	500
H2,5/25D BL	Mavi	9019180000	0,526 TL	500
H4,0/18D GR	Gri	9019190000	0,337 TL	500
H4,0/20D GR	Gri	9019200000	0,459 TL	500
H4,0/26D GR	Gri	9019210000	0,562 TL	100
H6,0/20 SW	Siyah	0533500000	0,464 TL	100
H6,0/26 SW	Siyah	0565700000	0,644 TL	100
H10,0/22 EB	Fildişi	0534200000	0,616 TL	100
H10,0/28 EB	Fildişi	0565800000	0,841 TL	100
H16,0/22 GN	Yeşil	0565900000	0,785 TL	100
H16,0/28 GN	Yeşil	0566000000	1,08 TL	100
H25,0/30 BR	Kahverengi	0317000000	1,79 TL	50
H25,0/36 BR	Kahverengi	0317100000	2,13 TL	50
H35,0/30 BE	Bej	0317200000	2,24 TL	50
H35,0/39 BE	Bej	0317300000	3,02 TL	50
H50/36 OLIV	Zeytin Yeşil	0444200000	3,92 TL	50
<b>Kablo Bağlantı Yüksükleri</b>				
<b>İzolesiz İletken Yüksükleri</b>				
H0,5/6	0.5 mm <sup>2</sup> / 6 mm	0282600000	0,109 TL	1000
H0,75/10	0.75 mm <sup>2</sup> / 10mm	0542500000	0,140 TL	1000
H1,0/10	1 mm <sup>2</sup> / 10mm	0282800000	0,180 TL	1000
H1,5/10	1.5 mm <sup>2</sup> / 10	0186500000	0,196 TL	1000
H2,5/12	2.5 mm <sup>2</sup> / 12mm	0186100000	0,211 TL	1000
H4,0/12	4 mm <sup>2</sup> / 12mm	0244100000	0,280 TL	1000
H6,0/12	6 mm <sup>2</sup> / 12mm	0191900000	0,336 TL	500
H10,0/12	10 mm <sup>2</sup> / 12mm	0282900000	0,392 TL	500
H16,0/12	16mm <sup>2</sup> / 12mm	0492500000	0,560 TL	500
<b>Kablo Bağlantı Yüksükleri</b>				
<b>Çift Girişli İzoleli İletken Yüksükleri</b>				
H0,5/14 ZH OR	Turuncu	9037200000	0,405 TL	500
H0,75/14 ZH W	Beyaz	9037230000	0,428 TL	500
H1,0/15 ZH GE	Sarı	9037260000	0,428 TL	500
H1,5/16 ZH R	Kırmızı	9037290000	0,428 TL	500
H2,5/19D ZH BL	Mavi	9037500000	0,504 TL	500
H4,0/22D ZH GR	Gri	9037530000	1,27 TL	100
H6,0/23 ZH SW	Siyah	9037320000	1,62 TL	100
H10,0/24 ZH EB	Fildişi	9037340000	1,90 TL	100
H16,0/29 ZH GN	Yeşil	9037360000	2,34 TL	50



H1,0/14 GE



H0,5/6

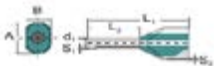

H0,5/14 ZH OR





H0,5/14 OR BD

Tip	Renk	Sipariş No	Fiyat/Birim	Ambalaj
<b>İzoleli Şerit Yüksükler (Stripax Plus için)</b>				
H0,5/14 OR BD	Turuncu	9004270000	0,237 TL	500
H0,75/14 W BD	Beyaz	9004290000	0,237 TL	500
H1,0/14 GE BD	Sarı	9004320000	0,237 TL	500
H1,5/14 R BD	Kırmızı	9004340000	0,237 TL	500
H2,5/14D BL BD	Mavi	9004360000	0,324 TL	500

Tip	Renk	Sipariş No	Fiyat/Birim	Ambalaj
<b>İzoleli Makara Şerit Yüksükler (Otomatik Makinalar için)</b>				
H0,5/14 OR BD GSP	Turuncu	9005810000	0,327 TL	5000
H0,75/14 W BD GSP	Beyaz	9005820000	0,327 TL	5000
H1,0/14 GE BD GSP	Yeşil	9005830000	0,327 TL	5000
H1,5/14 R BD GSP	Kırmızı	9005840000	0,327 TL	5000
H2,5/14D BL BD GSP	Mavi	9005850000	0,364 TL	3000
H0,5/14D W BD GSP	Beyaz	9005860000	0,327 TL	5000
H0,75/14D GR	gri	9005870000	0,327 TL	5000
H1,0/14D R BD GSP	Kırmızı	9005880000	0,327 TL	5000
H1,5/14D SW BD GSP	Siyah	9005890000	0,327 TL	5000
H0,75/14T BL BD GSP	Mavi	9005900000	0,327 TL	5000
H2,5/14T GR BD GSP	Gri	9005910000	0,364 TL	3000

Tip	Ölçü	Sipariş No	Fiyat/Birim	Ambalaj
-----	------	------------	-------------	---------

### İzoleli Kablo Pabuçları

#### Yuvarlak Uçlu Kablo Pabuçları

LIR 1,5M3 V	0.5 - 1.5 mm <sup>2</sup>	9200070000	0,672 TL	100
LIR 1,5M3,5 V	0.5 - 1.5 mm <sup>2</sup>	9200080000	0,672 TL	100
LIR 1,5M4 V	0.5 - 1.5 mm <sup>2</sup>	9200090000	0,813 TL	100
LIR 1,5M5 V	0.5 - 1.5 mm <sup>2</sup>	9200100000	0,784 TL	100
LIR 1,5M6 V	0.5 - 1.5 mm <sup>2</sup>	9200110000	1,23 TL	100
LIR 2,5M3 V	1.5 - 2.5 mm <sup>2</sup>	9200150000	0,829 TL	100
LIR 2,5M4 V	1.5 - 2.5 mm <sup>2</sup>	9200170000	0,996 TL	100
LIR 2,5M5 V	1.5 - 2.5 mm <sup>2</sup>	9200180000	0,996 TL	100
LIR 2,5M6 V	1.5 - 2.5 mm <sup>2</sup>	9200190000	1,32 TL	100
LIR 2,5M8 V	1.5 - 2.5 mm <sup>2</sup>	9200200000	1,34 TL	100
LIR 6M4 V	4.0 - 6.0 mm <sup>2</sup>	9200230000	1,76 TL	100
LIR 6M5 V	4.0 - 6.0 mm <sup>2</sup>	9200240000	1,75 TL	100
LIR 6M6 V	4.0 - 6.0 mm <sup>2</sup>	9200250000	2,02 TL	100
LIR 6M8 V	4.0 - 6.0 mm <sup>2</sup>	9200260000	2,43 TL	100

#### Çatal Uçlu Kablo Pabuçları

LIS 1,5M3 V	0.5 - 1.5 mm <sup>2</sup>	9200290000	0,762 TL	100
LIS 1,5M3,5 V	0.5 - 1.5 mm <sup>2</sup>	9200300000	0,784 TL	100
LIS 1,5M4 V	0.5 - 1.5 mm <sup>2</sup>	9200310000	0,785 TL	100
LIS 1,5M5 V	0.5 - 1.5 mm <sup>2</sup>	9200320000	0,896 TL	100
LIS 1,5M6 V	0.5 - 1.5 mm <sup>2</sup>	9200330000	1,27 TL	100
LIS 2,5M3,5 V	1.5 - 2.5 mm <sup>2</sup>	9200360000	0,952 TL	100
LIS 2,5M4 V	1.5 - 2.5 mm <sup>2</sup>	9200370000	0,913 TL	100
LIS 2,5M5 V	1.5 - 2.5 mm <sup>2</sup>	9200380000	0,986 TL	100
LIS 2,5M6 V	1.5 - 2.5 mm <sup>2</sup>	9200390000	1,34 TL	100
LIS 6M4 V	4.0 - 6.0 mm <sup>2</sup>	9200410000	1,68 TL	100
LIS 6M5 V	4.0 - 6.0 mm <sup>2</sup>	9200420000	1,77 TL	100
LIS 6M6 V	4.0 - 6.0 mm <sup>2</sup>	9200430000	2,13 TL	100
LIS 6M8 V	4.0 - 6.0 mm <sup>2</sup>	9200440000	2,82 TL	100



LIR 1,5M3 V



LIS 1,5M3 V



LIP 1,5R12 V



LIF 1,5F638 R



LIB 1,5B25 VF

Tip	Ölçü	Sipariş No	Fiyat/Birim	Ambalaj
<b>İğne Uçlu Kablo Pabuçları</b>				
LIP 1,5R12 V	0.5 - 1.5 mm <sup>2</sup>	9200460000	0,934 TL	100
LIP 2,5R12 V	1.5 - 2.5 mm <sup>2</sup>	9200470000	1,14 TL	100
LIP 6R14 V	4.0 - 6.0 mm <sup>2</sup>	9200480000	2,18 TL	100
<b>Faston Kablo Pabuçları</b>				
LIF 1,5F638 R	0.5 - 1.5 mm <sup>2</sup>	9200540000	1,00 TL	100
LIF 2,5F638 R	1.5 - 2.5 mm <sup>2</sup>	9200560000	1,09 TL	100
LIF 6F638 R	4.0 - 6.0 mm <sup>2</sup>	9200570000	1,52 TL	100
LIF 1,5M638 R	0.5 - 1.5 mm <sup>2</sup>	9200580000	1,01 TL	100
LIF 2,5M638 R	1.5 - 2.5 mm <sup>2</sup>	9200590000	1,03 TL	100
LIF 6M638 R	4.0 - 6.0 mm <sup>2</sup>	9200600000	1,43 TL	100
LIF 1,5F638 RF	0.5 - 1.5 mm <sup>2</sup>	9200640000	1,09 TL	100
LIF 2,5F638 RF	1.5 - 2.5 mm <sup>2</sup>	9200650000	1,18 TL	100
LIF 6F638 RF	4.0 - 6.0 mm <sup>2</sup>	9200660000	1,83 TL	100
Tip		Sipariş No	Fiyat/Birim	Ambalaj
<b>İzoleli Kablo Pabuçları</b>				
<b>Ek Muf</b>				
LIB 1,5B25 VF		9200490000	1,01 TL	100
LIB 2,5B25 VF		9200500000	1,12 TL	100
LIB 6B26 VF		9200510000	1,90 TL	100

## Yüksükler ve Pabuçlar

Tip		AWG	Renk kodları/sipariş no:			Manuel Aletler					Soyma ve Sıkma makinaları	
mm <sup>2</sup>	L2	AWG	Weidmüller	DIN	Çeşitli	Weidmüller	PZ 6 Roto / PZ 6 Roto L	PZ 6/5	PZ 3	PZ 16	CA 100 serisi	CRIMPRIX serisi
0.25	6	24	9025740000		9021010000							
0.25	8	24	9025760000		9021020000							
0.34	6	22	9025750000									
0.34	8	22	9025770000									
0.50	6	20	0409500000	9019000000								
0.50	8	20	0690700000	9019010000								
0.50	10	20	9025870000	9019020000								
0.75	6	18	0409600000	9019020000	9021030000							
0.75	8	18	0462900000	9019040000	9021040000							
0.75	10	18	9025860000	9019050000	9021050000							
0.75	12	18	9025910000	9019060000	9021060000							
1.00	6	18	0409700000	9019070000								
1.00	8	18	0463000000	9019080000								
1.00	10	18	9025950000	9019100000								
1.00	12	18	9025930000	9019110000								
1.5	6	16	9025960000									
1.5	8	16	0463100000	9019120000								
1.5	10	16	0635100000	9019130000								
1.5	12	16		9019140000								
1.5	18	16	0565600000	9019150000								
2.5	6	14		9028490000	9036200000							
2.5	8	14		9019160000	9021070000							
2.5	10	14		9036220000	9036210000							
2.5	12	14		9019170000	9021080000							
2.5	18	14		9019180000	9021090000							
4	8	12		9028520000	9036230000							
4	10	12		9019190000	9021100000							
4	12	12		9019200000	9021110000							
4	18	12		9019210000	9021120000							
6	12	10	0533500000	9019220000	9021130000							
6	18	10	0565700000	9019230000	9021140000							
10	12	8	0534200000	9019240000	9021150000							
10	18	8	0565800000	9019250000	9021160000							
16	12	6	0565900000	9019260000	9021170000							
16	18	6	0566000000	9019270000	9021180000							



CD 80x60 4/6

Tip	Yükseklik x Genişlik	Sipariş No	Fiyat/Birim	Ambalaj
<b>Kablo Kanalları</b>				
CD 30x25 4/6	30X25 cm	2589110000	26,90 TL	80M
CD 40x25 4/6	40X25 cm	2589130000	30,25 TL	60M
CD 60x25 4/6	60X25 cm	2589150000	43,70 TL	40M
CD 80x25 4/6	80X25 cm	2589180000	62,70 TL	32M
CD 40x40 4/6	40X40 cm	2589210000	40,30 TL	40M
CD 60x40 4/6	60X40 cm	2589230000	52,65 TL	36M
CD 80x40 4/6	80X40 cm	2589240000	71,70 TL	24M
CD 100x40 4/6	100X40 cm	2589260000	89,60 TL	16M
CD 40x60 4/6	40X60 cm	2589280000	50,40 TL	24M
CD 60x60 4/6	60X60 cm	2589300000	62,70 TL	24M
CD 80x60 4/6	80X60 cm	2589310000	78,40 TL	24M
CD 100x60 4/6	100X60 cm	2589330000	118,70 TL	16M
CD 60x80 4/6	60X80 cm	2589370000	76,15 TL	24M
CD 80x80 4/6	80X80 cm	2589380000	98,55 TL	24M
CD 100x80 4/6	100X80 cm	2589400000	128,80 TL	16M
CD 60x100 4/6	60X100 cm	2589420000	95,20 TL	20M
CD 80x100 4/6	80X100 cm	2589440000	118,70 TL	16M
CD 100x100 4/6	100X100 cm	2589450000	215,05 TL	16M
CD 60x120 4/6	60X120 cm	2589470000	143,85 TL	16M
CD-BO 80X120 4/6 GY	80X120 cm	2589490000	153,45 TL	16M
CD-LID 25	25 cm - Kapak	2590110000	18,10 TL	2M
CD-LID 40	40 cm - Kapak	2590080000	31,60 TL	2M
CD-LID 60	60 cm - Kapak	2590050000	61,70 TL	2M
CD-LID 80	80 cm - Kapak	2590020000	72,25 TL	2M
CD-LID 100	100 cm - Kapak	2590000000	82,75 TL	2M
CD-LID 120	120 cm - Kapak	2589990000	100,80 TL	2M
CD 100x40 8/12	100X40 cm	2588630000	105,30 TL	16M
CD 100x60 8/12 GY	100X60 cm	2588720000	145,60 TL	16M
CD-BO 100X80 8/12 GY	100X80 cm	2588790000	150,40 TL	16M
CD 100x100 8/12	100X100 cm	2588850000	224,00 TL	16M
CD 40x25 8/12	40X25 cm	2588460000	38,90 TL	60M
CD 40x40 8/12	40X40 cm	2588580000	49,45 TL	40M
CD 80x80 8/12	80X80 cm	2588770000	137,80 TL	24M



TS35 x 7,5

Tip	Açıklama	Sipariş No	Fiyat/Birim	Ambalaj
<b>İthal Raylar</b>				
TS35 x 7,5	Çelik Deliksiz Ray (Sipariş şekli: 40 mt ve katları)	7730000011	30,85 TL	40M
TS32	Çelik Deliksiz Ray	7730000012	63,20 TL	20M
TS35 x 7,5 D	Çelik Delikli Ray (Sipariş şekli: 40 mt ve katları)	7730000013	35,75 TL	40M
TS32 D	Çelik Delikli Ray	7730000014	72,90 TL	20M
TS 35X15	Çelik Deliksiz Ray	7730000490	78,55 TL	20M
TS 35X15 D	Çelik Delikli Ray	7730000458	71,70 TL	20M
<b>Orijinal Weidmüller Raylar</b>				
TS 35X7.5 2M/ST/ZN	Çelik Deliksiz Ray	0383400000	63,85 TL	2M
TS 35X7.5/LL 2M/ST/ZN	Çelik Delikli Ray (Sipariş şekli: 40 mt ve katları)	0514500000	68,80 TL	40M
TS 35X15 2M/ST/ZN	Çelik Deliksiz Ray (Sipariş şekli: 20 mt ve katları)	0236400000	115,00 TL	20M
TS 35X15/LL 2M/ST/ZN	Çelik Delikli Ray (Sipariş şekli: 20 mt ve katları)	0236500000	117,80 TL	20M
TS 32X15 2M/ST/ZN	Çelik Deliksiz Ray	0122800000	96,10 TL	2M
TS 32X15/LL 2M/ST/ZN	Çelik Delikli Ray	0514400000	120,55 TL	2M
TS 15X5 2M/ST/ZN	Çelik Deliksiz Ray	0514200000	58,95 TL	2M
TS 15X5/LL 2M/ST/ZN	Çelik Delikli Ray	0117500000	49,30 TL	2M



TSTW 5/M5



Schuko TS35



RACCORDO 50

Tip	Açıklama	Sipariş No	Fiyat/Birim	Ambalaj
<b>Ray Taşıyıcı</b>				
TSTW 5/M5	M5 Ray Montaj Ayağı	0178100000	24,45 TL	10
TSTW 6/M6	M6 Ray Montaj Ayağı	0164000000	24,45 TL	10
SH 2	TS 32 ve TS 35 İçin	0494920000	53,20 TL	10
<b>TS 35 Raya Montaj Tek Fazlı Priz</b>				
Schuko TS35	Ray Prizi	8734580000	14,00 €	10
<b>Spiral Hortumlar</b>				
FLEX. D8		7730000459	8,96 TL	30
FLEX. D10		7730000015	9,18 TL	30M
FLEX. D12		7730000016	10,10 TL	30M
FLEX. D14		7730000017	12,30 TL	30M
FLEX. D16		7730000018	13,45 TL	30M
FLEX. D20		7730000019	15,70 TL	30M
FLEX. D22		7730000020	16,80 TL	30M
FLEX. D25		7730000409	19,05 TL	30M
FLEX. D28		7730000021	26,90 TL	30M
FLEX. D32		7730000022	29,10 TL	30M
FLEX. D35		7730000023	33,60 TL	30M
FLEX. D40		7730000460	40,30 TL	30M
FLEX. D50		7730000025	58,25 TL	30M
FLEX. D60		7730000461	63,85 TL	30
<b>Rakorlar</b>				
RACCORDO 10 1/2		7730000026	11,20 TL	50
RACCORDO 12-3/8		7730000027	11,20 TL	50
RACCORDO 14-1/2		7730000028	12,30 TL	50
RACCORDO 16-1/2		7730000029	13,45 TL	50
RACCORDO 20		7730000031	14,80 TL	50
RACCORDO 22-3/4		7730000032	15,70 TL	50
RACCORDO 28-1		7730000033	21,30 TL	25
RACCORDO 32		7730000489	23,50 TL	25
RACCORDO 35		7730000035	26,90 TL	20
RACCORDO 40-1/2		7730000481	39,20 TL	15
RACCORDO 50		7730000037	52,65 TL	10

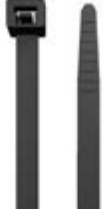

CB 98/2.5 BLACK

Tip	Renk	Sipariş No	Fiyat/Birim	Ambalaj
<b>Kablo Bağları</b>				
CB 98/2.5 NATUR	Beyaz	1278600000	0,078 TL	100
CB 98/2.5 BLACK	Siyah	1697890000	0,078 TL	100
CB 135/2.5 NATUR	Beyaz	7940006040	0,146 TL	100
CB 135/2.5 BLACK	Siyah	7940006047	0,146 TL	100
CB 200/2.6 NATUR	Beyaz	7940006050	0,164 TL	100
CB 200/2.6 BLACK	Siyah	7940006051	0,164 TL	100
CB 140/3.5 NATUR	Beyaz	1278700000	0,179 TL	100
CB 140/3.5 BLACK	Siyah	1697900000	0,179 TL	100
CB 200/3.5 NATUR	Beyaz	1720630000	0,231 TL	100
CB 200/3.5 BLACK	Siyah	1720660000	0,231 TL	100
CB 290/3.5 NATUR	Beyaz	1720640000	0,337 TL	100
CB 290/3.5 BLACK	Siyah	1720650000	0,337 TL	100
CB 370/3.5 NATUR	Beyaz	7940006056	0,739 TL	100
CB 370/3.5 BLACK	Siyah	7940006057	0,739 TL	100
CB 200/4.8 NATUR	Beyaz	1278800000	0,336 TL	100
CB 200/4.8 BLACK	Siyah	1697910000	0,336 TL	100
CB 160/4.5 NATUR	Beyaz	1723540000	0,344 TL	100
CB 160/4.5 BLACK	Siyah	1723560000	0,344 TL	100
CB 178/4.8 NATUR	Beyaz	1723550000	0,348 TL	100
CB 178/4.8 BLACK	Siyah	1723570000	0,348 TL	100
CB 290/4.5 NATUR	Beyaz	1278900000	0,478 TL	100
CB 290/4.5 BLACK	Siyah	1697920000	0,478 TL	100
CB 360/4.5 NATUR	Beyaz	1279000000	0,594 TL	100
CB 360/4.5 BLACK	Siyah	1697930000	0,594 TL	100
CB 180/7.8 NATUR	Beyaz	7940006064	0,700 TL	100
CB 180/7.8 BLACK	Siyah	7940006065	0,700 TL	100
CB 300/7.8 NATUR	Beyaz	7940006068	1,01 TL	100
CB 300/7.8 BLACK	Siyah	7940006069	1,01 TL	100
CB 365/7.5 NATUR	Beyaz	1279100000	1,28 TL	100
CB 365/7.5 BLACK	Siyah	1697940000	1,28 TL	100
CB 450/7.5 NATUR	Beyaz	7940006070	1,79 TL	100
CB 450/7.5 BLACK	Siyah	7940006071	1,79 TL	100
CB 540/7.5 NATUR	Beyaz	7940006072	2,03 TL	100
CB 540/7.5 BLACK	Siyah	7940006073	2,03 TL	100
CB 750/7.5 NATUR	Beyaz	1720680000	2,96 TL	100
CB 750/7.5 BLACK	Siyah	1720670000	2,96 TL	100
CB 780/9.0 NATUR	Beyaz	7940006074	6,05 TL	100
CB 780/9.0 BLACK	Siyah	7940006075	6,05 TL	100
CBH 19/19 NATUR	Kablo Bağı Taşıyıcı	1289200000	0,784 TL	100
CBH 27/27 NATUR	Kablo Bağı Taşıyıcı	1289400000	1,01 TL	100



SCT 4,6/127 C

Tip	Sipariş No	Fiyat/Birim	Ambalaj
<b>Paslanmaz Çelik Kablo Bağları</b>			
SCT 4,6/127 C	1699800000	1,20 €	100
SCT 4,6/201 C	1699810000	1,25 €	100
SCT 4,6/266C	1699900000	1,50 €	100
SCT 4,6/360 C	1699910000	1,50 €	100
SCT 4,6/520	1699920000	2,10 €	100
SCT 4,6/679	1699930000	2,70 €	100
SCT 4,6/838	1699940000	3,65 €	100



SCT-C 4.6/100

Tip	Sipariş No	Fiyat/Birim	Ambalaj
<b>Yüzeyi Tam Kaplamalı İzoleli Paslanmaz Çelik Kablo Bağları</b>			
SCT-C 4.6/100	1015220000	0,95 €	100
SCT-C 4.6/125	1015230000	1,05 €	100
SCT-C 4.6/150	1015240000	1,05 €	100
SCT-C 4.6/200	1015250000	1,30 €	100
SCT-C 4.6/360	1015270000	1,45 €	100
SCT-C 4.6/520	1015280000	1,70 €	100
SCT-C 4.6/680	1015290000	2,10 €	100
SCT-C 4.6/840	1015300000	3,00 €	100
SCT-C 7.9/200	1015310000	2,00 €	100
SCT-C 7.9/360	1015320000	2,00 €	100
SCT-C 7.9/520	1015330000	2,50 €	100
SCT-C 7.9/680	1015340000	2,45 €	100
SCT-C 7.9/840	1015350000	2,80 €	100



CB-VT 98/2.5 HF/VO WT

Tip	Dayanım Kuvveti / Malzeme	Sipariş No	Fiyat/Birim	Ambalaj
<b>Raylı Sistemler ve Robotik Uygulamalar için Kablo Bağları</b>				
CB-VT 98/2.5 HF/VO WT	80 N / Halojen free	2659490000	0,605 TL	100
CB-VT 140/3.5 HF/VO WT	150 N / Halojen free	2659500000	0,990 TL	100
CB-VT 200/3.5 HF/VO WT	150 N / Halojen free	2659510000	1,42 TL	100
CB-VT 200/4.5 HF/VO WT	220 N / Halojen free	2659520000	1,53 TL	100
CB-VT 290/4.5 HF/VO WT	220 N / Halojen free	2659530000	3,29 TL	100
CB-VT 365/7.5 HF/VO WT	540 N / Halojen free	2659540000	4,97 TL	100



CB-HTR 98/2.5

Tip	Renk	Sipariş No	Fiyat/Birim	Ambalaj
<b>Yüksek Sıcaklık Uygulamaları ( +125 °C Dereceye kadar)</b>				
CB-HTR 98/2.5	Beyaz	2659430000	0,672 TL	100
CB-HTR 98/2.5	Siyah	2659370000	0,672 TL	100
CB-HTR 140/3.5	Beyaz	2659440000	0,990 TL	100
CB-HTR 140/3.5	Siyah	2659380000	0,841 TL	100
CB-HTR 200/3.5	Beyaz	2659450000	1,42 TL	100
CB-HTR 200/3.5	Siyah	2659390000	1,43 TL	100
CB-HTR 200/4.5	Beyaz	2659460000	1,53 TL	100
CB-HTR 200/4.5	Siyah	2659400000	1,53 TL	100
CB-HTR 290/4.5	Beyaz	2659470000	3,29 TL	100
CB-HTR 290/4.5	Siyah	2659410000	3,29 TL	100
CB-HTR 365/7.5	Beyaz	2659480000	4,97 TL	100
CB-HTR 365/7.5	Siyah	2659420000	4,97 TL	100



CB-DT 100/2.5 BL

Tip	Dayanım Kuvveti / Malzeme	Sipariş No	Fiyat/Birim	Ambalaj
<b>Açık Alan Uygulamaları (UV ISO-4892-2A, DNV-GL)</b>				
CB-UVR 98/2.5 BK	80 N / Halojen free	2659310000	0,672 TL	100
CB-UVR 140/3.5 BK	150 N / Halojen free	2659320000	0,990 TL	100
CB-UVR 200/3.5 BK	150 N / Halojen free	2659330000	1,46 TL	100
CB-UVR 200/4.5 BK	220 N / Halojen free	2659340000	1,83 TL	100
CB-UVR 290/4.5 BK	220 N / Halojen free	2659350000	3,29 TL	100
CB-UVR 365/7.5 BK	540 N / Halojen free	2659360000	4,97 TL	100
<b>Detectable(Algılanabilir) Kablo Bağları</b>				
CB-DT 100/2.5 BL	80 N / Halojen free	2602750000	1,20 TL	100
CB-DT 140/3.5 BL	150 N / Halojen free	2602760000	2,67 TL	100
CB-DT 200/4.5 BL	150 N / Halojen free	2602770000	3,09 TL	100
CB-DT 280/4.5 BL	220 N / Halojen free	2602780000	6,65 TL	100
CB-DT 380/4.5 BL	220 N / Halojen free	2602790000	8,27 TL	100
CB-DT 360/7.5 BL	540 N / Halojen free	2602800000	14,65 TL	100



IE-FC-SFM-KNOB



IE-FC-SFP-KNOB



IE-FC-SP-PWB/2ST



IE-FC-SP-PWS/2ST/1D9



IE-BI-RJ45-FJ-A



IE-BI-USB-A



IE-FCI-D9-FM

Tip	Açıklama	Sipariş No	Fiyat/Birim	Ambalaj
<b>IP 65 Koruma Kapakları</b>				
IE-FC-SFM-KNOB	Metal hazne, butonlu ön kapak	1450530000	40,65 €	1
IE-FC-SFM-KEY	Metal hazne, kilitli ön kapak	1450540000	53,85 €	1
IE-FC-SFP-KNOB	Plastik hazne, butonlu ön kapak	1450510000	38,00 €	1
IE-FC-SFP-KEY	Plastik hazne, kilitli ön kapak	1450520000	56,00 €	1
IE-FC-DFM-KNOB	Çiftli Metal hazne, butonlu ön kapak	2003170000	59,05 €	1
IE-FC-DFM-KEY	Çiftli Metal hazne, kilitli ön kapak	2003180000	80,00 €	1
IE-FC-DFM-CAB	Çiftli Metal hazne, kabin kilitli ön kapak	2003190000	59,05 €	1
IE-FC-DFM-CAB-DB	Çiftli Metal hazne, kabin kilitli ön kapak (Daimler)	2003150000	59,05 €	1
<b>IP 20 İç Montaj Plakaları</b>				
IE-FC-SP-PWB/2ST	1x Enerji, 2x Data, izoleli, shielding	1450550000	30,00 €	1
IE-FC-IP-PWB/2ST	1x Enerji, 2x Data, izolesiz	1450630000	16,00 €	1
IE-FC-SP-PWS/2ST/1D9	1x Enerji, 2x Data, 1x Sinyal, izoleli, shielding	1450600000	36,00 €	1
IE-FC-IP-PWS/2ST/1D9	1x Enerji, 2x Data, 1x Sinyal, izolesiz	1450690000	16,00 €	1
IE-FC-SP-PWS/4ST	1x Enerji, 4x Data, izoleli, shielding	1450570000	36,00 €	1
IE-FC-IP-PWS/4ST	1x Enerji, 4x Data, izolesiz	1450640000	16,00 €	1
IE-FC-SP-PWS/2D9	1x Enerji, 2x Sinyal, izoleli, shielding	1450610000	36,00 €	1
IE-FC-IP-PWS/2D9	1x Enerji, 2x Sinyal, izolesiz	1450680000	16,00 €	1
IE-FC-SP-PWU/2ST	1x Enerji, 2x Data, izoleli, shielding	1450620000	36,00 €	1
IE-FC-IP-PWU/2ST	1x Enerji, 2x Data, izolesiz	1450700000	16,00 €	1
IE-FC-SP-2ST/2D9	2x Data, 2x Sinyal, izoleli, shielding	1450590000	36,00 €	1
IE-FC-IP-2ST/2D9	2x Data, 2x Sinyal, izolesiz	1450670000	16,00 €	1
IE-FC-SP-1ST/1D9/1D25	1x Data, 2x Sinyal, izoleli, shielding	1450580000	36,00 €	1
IE-FC-IP-1ST/1D9/1D25	1x Data, 2x Sinyal, izolesiz	1450650000	16,00 €	1
<b>IP 20 Double İç Montaj Plakaları</b>				
IE-FC-DSP-CI/3A/2ST/1D9	1x GFCl, 1x Sigorta, 2x Data, 1x Sinyal, izoleli	2004810000	76,85 €	1
IE-FC-DIP-CI/3A/2ST/1D9	1x GFCl, 1x Sigorta, 2x Data, 1x Sinyal, izolesiz	2003370000	70,00 €	1
IE-FC-DSP-PWB/2ST/FILS	1x Güç, 2x Data, 1x LS Switch, izoleli	2067080000	33,90 €	1
IE-FC-DIP-PWB/2ST/FILS	1x Güç, 2x Data, 1x LS Switch, izolesiz	2067070000	18,10 €	1
IE-FC-DIP-BP	İzolesiz plaka	2004890000	16,70 €	1
<b>RJ 45 Modülleri</b>				
IE-BI-RJ45-FJ-A	TIA-A. Cat. 6A	1962850000	19,50 €	10
IE-BI-RJ45-FJ-B	TIA-B. Cat. 6A	1963840000	19,50 €	10
IE-BI-RJ45-FJ-P	RJ45 Soket, Profinet	1963830000	22,00 €	1
IE-BI-RJ45-C	Çift taraflı RJ45 dişi soket	1962840000	20,00 €	1
<b>USB Modülleri</b>				
IE-BI-USB-A	USB A/A 2.0	1019570000	13,10 €	10
IE-BI-USB-3.0-A	USB A/A 3.0	1487920000	25,00 €	1
IE-BI-USB-AB	USB A/B 2.0	1131380000	13,00 €	1
<b>D-Sub Modülleri</b>				
<b>9-Pole</b>				
IE-FCI-D9-FF	Dişi - Dişi	1450840000	7,50 €	1
IE-FCI-D9-FM	Dişi - Erkek	1450850000	7,50 €	1
IE-FCI-D9-FS	Dişi - Lehim Bağlantısı	1450870000	5,20 €	1
<b>25-Pole</b>				
IE-FCI-D25-FF	Dişi - Dişi	1450880000	9,50 €	1
IE-FCI-D25-FM	Dişi - Erkek	1450890000	9,50 €	1
IE-FCI-D25-FS	Dişi - Lehim Bağlantısı	1450900000	8,00 €	1





IE-FCI-PWB-DE



WIL-STANDARD-10-MAG-SW-WHI

Tip	Açıklama	Sipariş No	Fiyat/Birim	Ambalaj	
<b>Priz</b>					
IE-FCI-PWB-DE	IP 20 250V 16 A, Alman Standartı	1450730000	20,00 €	1	
IE-FCI-PWB-GB	IP 20 250V 16 A, Fransız Standartı	1450770000	20,55 €	1	
IE-FCI-PWB-RCBO	230V AC 16A	1534250000	180,00 €	1	
Tip	Nom. V / Nom A	Aydınlatma Seviyesi / Işık Rengi (CCT) / Uzunluk	Sipariş No	Fiyat/Birim	Ambalaj
<b>Pano İçi LED Aydınlatma Ürünleri</b>					
<b>Vida ile Pano Montajlı</b>					
WIL-STANDARD-0.3-SCREW-SW-WHI	24 V DC / 420 mA	140 lux / 6500K, White / 240mm	2436210000	175,00 €	1
WIL-STANDARD-0.3-SCREW-SW-RED	24 V DC / 360 mA	70 lux / Red / 240mm	2436340000	300,00 €	1
WIL-STANDARD-0.3-SCREW-SW-BLU	24 V DC / 360 mA	135 lux / Blue / 240mm	2436350000	255,00 €	1
WIL-STANDARD-1.5-SCREW-SW-WH	24 V DC / 420 mA	140 lux / 6500K, White / 240mm	2527880000	173,00 €	1
WIL-STANDARD-3.0-SCREW-SW-WHI	24 V DC / 420 mA	140 lux / 6500K, White / 240mm	2527890000	180,00 €	1
WIL-STANDARD-5.0-SCREW-SW-WHI	24 V DC / 420 mA	140 lux / 6500K, White / 240mm	2527900000	191,00 €	1
WIL-STANDARD-10-SCREW-SW-WHI	24 V DC / 420 mA	140 lux / 6500K, White / 240mm	2527910000	222,00 €	1
<b>Mıknatıs ile Pano Montajlı</b>					
WIL-STANDARD-1.5-MAG-SW-WHI	24 V DC / 420 mA	140 lux / 6500K, White / 240mm	2527920000	197,00 €	1
WIL-STANDARD-10-MAG-SW-WHI	24 V DC / 420 mA	140 lux / 6500K, White / 240mm	2527950000	249,00 €	1
WIL-STANDARD-3.0-MAG-SW-WHI	24 V DC / 420 mA	140 lux / 6500K, White / 240mm	2527930000	209,00 €	1
WIL-STANDARD-5.0-MAG-SW-WHI	24 V DC / 420 mA	140 lux / 6500K, White / 240mm	2527940000	219,00 €	1
<b>WIL Uzunluk Varyantı</b>					
WIL-145-W-M12G-0.3U-S	24 V DC / 210 mA	140 lux / 6500K, White / 145mm	2535770000	131,00 €	1
WIL-350-W-M12G-0.3U-S	24 V DC / 630 mA	140 lux / 6500K, White / 350mm	2535810000	222,00 €	1
WIL-450-W-M12G-0.3U-S	24 V DC / 840 mA	140 lux / 6500K, White / 450mm	2535830000	286,00 €	1
WIL-555-W-M12G-0.3U-S	24 V DC / 1050 mA	140 lux / 6500K, White / 555mm	2535850000	353,00 €	1
WIL-655-W-M12G-0.3U-S	24 V DC / 1260 mA	140 lux / 6500K, White / 655mm	2535870000	420,00 €	1
WIL-765-W-M12G-0.3U-S	24 V DC / 1470 mA	140 lux / 6500K, White / 765mm	2535890000	509,00 €	1
WIL-860-W-M12G-0.3U-S	24 V DC / 1680 mA	140 lux / 6500K, White / 860 mm	2535910000	553,00 €	1
<b>Aksesuarlar</b>					
WIL-MAGNET			2526810000	29,95 €	1

## u-mation Otomasyon Ürün Grubu

Weidmüller u-mation ürün ailesi geleceğin akıllı makineleri ve tesisleri için mükemmel bir şekilde koordine edilmiş ürün portföyü sunar. Endüstri 4.0 ve Sensörden Buluta Endüstriyel Haberleşme ilkesine bağlı olarak geliştirilen u-mation ailesi platform bağımsız, hızlı entegrasyon, esnek yapısıyla kullanıcılarına benzersiz deneyim sunmaktadır.

**u-control 2000** piyasadaki en modern ve kompakt PLC'lerden biridir ve mühendislik ortamlarınız için mükemmel çözümler sunmaktadır. Yaratıcı Nesnelerin İnterneti (IoT) ve otomasyon projeleriniz için geliştirilmiş olan u-control 2000; modüler tasarımı sayesinde 100'den fazla u-remote I/O modülü ile genişleme imkânı sağlamaktadır. IEC 61131-3 standartlarına uyumlu olarak CODESYS veya web tabanlı programlama platformları sistemlerinize mükemmel avantajlar kazandırır.

**u-remote IP20 ve IP67** uzak I/O sistemi hızlı ve pratik kurulumun yanı sıra sistemin güvenli şekilde başlatılması ve arıza sebepli duruşların minimize edilmesi açısından uygulamalara yönelik tam uyumlu çözümler sunmaktadır. İnce modül dizaynı ve modül beslemelerinde daha az güç kaynağı ihtiyacı duyan teknolojisi ile pano içinde az yer kaplayarak pano tasarımlarını küçültür. Çeşitli bus protokollerini destekleyebilen akıllı modülleri ile IP 67 remote I/O modülleri interface kartlar yardımı ile IP 20 I/O grupları ile aynı sistem içerisinde pratik bir şekilde kullanılabilir.

**u-view** HMI ve Endüstriyel PC ürünleri sistemlerinizin izlenmesi ve kontrolü için mükemmel görselleştirme imkanı sunmaktadır. u-view HMI portföyünü oluşturan kapasitif ve rezistif dokunmatik ekranlar; web teknolojilerini destekleyen işletim sistemi ile birlikte donanımsal ve yazılımsal bağımsızlık sağlamaktadır. u-view IPC ürünleri gamında bulunan Box PC, Panel PC ve Monitörler; kompakt ve güçlü donanım yapısı ile tesislerinizde ve otomasyon sistemlerinizde maksimum performans ve gücü garanti etmektedir.

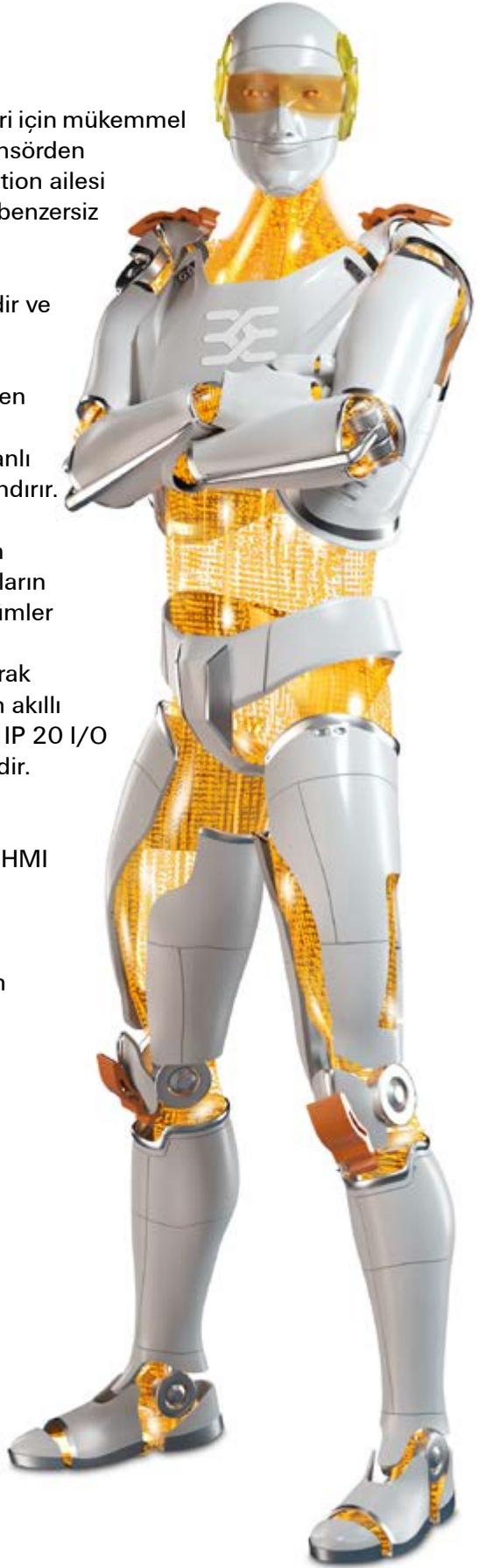



UC20-WL2000-IOT



U-CREATE-STUDIO



U-CREATE-PROCON-WE-B-RT-ES-2000



UR20-FBC-CC



UR20-FBC-MOD-TCP-ECO



UR20-8DIO-P-3W-DIAG



UR20-2DI-P-TS

Tip	Açıklama	Sipariş No	Fiyat/Birim	Ambalaj
<b>u-control 2000 PLC Serisi</b>				
UC20-WL2000-AC	Web tabanlı PLC (Yazılım programı gerekmez)	1334950000	690,00 €	1
UC20-SL2000-OLAC-EC	CODESYS tabanlı PLC, EtherCAT protokolüne sahip	2638920000	825,00 €	1
UC20-WL2000-IOT	Node-RED tabanlı IOT Kontrolör	1334990000	600,00 €	1
<b>u-control 2000 Serisi - PLC Yazılımları</b>				
* U-CREATE-STUDIO	PLC programlama yazılımı	2660130000	3.830,00 €	1
<b>u-view HMI lisans ve tasarım araçları</b>				
* U-CREATE-PROCON-WE-B-D-ES-100	u-control studio için HMI tasarım aracı, 100 tag (Runtime lisansına ihtiyaç yoktur)	2705820000	433,00 €	1
* U-CREATE-PROCON-WE-B-D-ES-2000	u-control studio için HMI tasarım aracı, 2000 tag	2705830000	1.322,00 €	1
* U-CREATE-PROCON-WE-B-RT-ES-2000	u-create PROCON WEB Runtime Lisansı (u-control studio için)	2708630000	182,00 €	1
<b>u-remote I/O Modülleri</b>				
<b>Coupler Modülleri</b>				
UR20-FBC-PB-DP-V2	Profibus DP V2 Coupler	2614380000	390,00 €	1
UR20-FBC-PN-IRT-V2	Profinet RT & IRT Coupler	2566380000	428,00 €	1
UR20-FBC-EC	EtherCAT Coupler	1334910000	369,00 €	1
UR20-FBC-CAN	CANopen Coupler	1334890000	405,00 €	1
UR20-FBC-EIP	Ethernet/IP Coupler	1334920000	410,00 €	1
UR20-FBC-MOD-TCP-V2	Modbus TCP V2 Coupler (2 CPU ile senkronize ayrı network hatları üzerinden haberleşme)	2476450000	430,00 €	1
UR20-FBC-PL	Powerlink Coupler	1334940000	400,00 €	1
UR20-FBC-DN	DeviceNet Coupler	1334900000	405,00 €	1
UR20-FBC-IEC61162-450	Fieldbuscoupler IEC 61162-450	2661310000	580,00 €	1
* UR20-FBC-CC	CC-Link Serial Coupler	2625010000	450,00 €	1
<b>ECO Seri Coupler Modülleri</b>				
* UR20-FBC-PN-ECO	PROFINET RT Coupler	2659680000	290,00 €	1
* UR20-FBC-MOD-TCP-ECO	Modbus/TCP Coupler	2659700000	290,00 €	1
* UR20-FBC-EC-ECO	EtherCAT Coupler	2659690000	290,00 €	1
<b>Dijital Input Modülleri</b>				
UR20-4DI-2W-230V-AC	4 DI Modülü (2 kablolu) 230V AC	1550070000	67,50 €	1
UR20-4DI-P	4 DI Modülü (2, 3, 3 + FE kablolu), Pozitif Anahtarlamalı	1315170000	45,00 €	1
UR20-4DI-P-3W	4 DI Modülü (2, 3 kablolu), Pozitif Anahtarlamalı	2009360000	45,00 €	1
UR20-4DI-N	4 DI Modülü (2, 3, 3 + FE kablolu), Negatif Anahtarlamalı	1315350000	57,00 €	1
UR20-8DI-P-2W	8 DI Modülü (2 kablolu), Pozitif Anahtarlamalı	1315180000	68,00 €	1
UR20-8DI-P-3W	8 DI Modülü (2 ve 3 kablolu), Pozitif Anahtarlamalı	1394400000	70,00 €	1
UR20-8DI-N-3W	8 DI Modülü (2 ve 3 kablolu), Negatif Anahtarlamalı	1315370000	81,50 €	1
UR20-8DI-ISO-2W	8 DI Modülü (500V'a kadar Galvanik İzolasyonlu)	2457240000	100,00 €	1
UR20-8DIO-P-3W-DIAG	8 DIO Modülü (Input veya output olarak ayarlanabilir), Pozitif Anahtarlamalı	2456530000	180,00 €	1
UR20-16DI-P	16 DI Modülü (1 kablolu), Pozitif Anahtarlamalı	1315200000	98,00 €	1
UR20-16DI-N	16 DI Modülü (1 kablolu), Negatif Anahtarlamalı	1315390000	109,00 €	1
UR20-16DI-P-PLC-INT	16 DI Modülü (PLC Interface), Pozitif Anahtarlamalı	1315210000	117,00 €	1
UR20-16DI-N-PLC-INT	16 DI Modülü (PLC Interface), Negatif Anahtarlamalı	1315400000	116,00 €	1
UR20-8DI-P-3W-HD	8 DI HD Modülü (8 konektör x 4 bağlantı noktası)(2 ve 3 kablolu)	1315190000	57,00 €	1
<b>Time Stamp</b>				
UR20-2DI-P-TS	2 DI Modülü (2, 3, 3 + FE kablolu), Time Stamp, Sensör ve Transmitter uygulamaları	1460140000	75,50 €	1
UR20-4DI-P-TS	4 DI Modülü (2, 3, 3 + FE kablolu), Time Stamp, Sensör ve Transmitter uygulamaları	1460150000	170,00 €	1



UR20-4DO-P



UR20-4RO-SSR-255



UR20-4AI-UI-DIF-16-DIAG



UR20-4AI-UI-16-DIAG



UR20-4AI-16-DIAG-HD



UR20-4AO-UI-16-M-DIAG



UR20-1SM-50W-6DI2DO-P

Tip	Açıklama	Sipariş No	Fiyat/Birim	Ambalaj
<b>Dijital Output Modülleri</b>				
UR20-4DO-P	4 DO Modülü (2, 3, 3 + FE kablolu), 0.5A/ kanal, Pozitif Anahtarlama	1315220000	49,50 €	1
UR20-4DO-N	4 DO Modülü (2, 3, 3 + FE kablolu), 0.5A/ kanal, Negatif Anahtarlama	1315410000	63,00 €	1
UR20-4DO-ISO-4A	4 DO Modülü (500V'a kadar Galvanik İzolasyonlu), 4A/ kanal	2457250000	Sorunuz	Sorunuz
UR20-4DO-P-2A	4 DO Modülü (2, 3, 3 + FE kablolu), 2A/ kanal, Pozitif Anahtarlama	1315230000	80,00 €	1
UR20-4DO-PN-2A	4 DO Modülü (2, 3, 3 + FE kablolu), 2A/ kanal, Pozitif ve Negatif Anahtarlama	1394420000	113,00 €	1
UR20-4DO-N-2A	4 DO Modülü (2, 3, 3 + FE kablolu), 2A/ kanal, Negatif Anahtarlama	1315420000	95,00 €	1
UR20-8DO-N	8 DO Modülü (2 kablolu), 0.5A/ kanal, Negatif Anahtarlama	1315430000	92,00 €	1
UR20-8DO-P	8 DO Modülü (2 kablolu), 0.5A/ kanal, Pozitif Anahtarlama	1315240000	78,00 €	1
UR20-16DO-P	16 DO Modülü (1 kablolu), 0.5A/ kanal, Pozitif Anahtarlama	1315250000	118,00 €	1
UR20-16DO-N	16 DO Modülü (1 kablolu), 0.5A/ kanal, Negatif Anahtarlama	1315440000	120,00 €	1
UR20-16DO-P-PLC-INT	16 DO Modülü (PLC Interface), 0.5A/ kanal, Pozitif Anahtarlama	1315270000	135,00 €	1
UR20-16DO-N-PLC-INT	16 DO Modülü (PLC Interface), 0.5A/ kanal, Negatif Anahtarlama	1315450000	135,00 €	1
UR20-8DO-P-2W-HD	8 DO HD Modülü (2 kablolu), 0.5A/ kanal, Pozitif Anahtarlama	1509830000	70,50 €	1
<b>Röle ve SS Röle Modülleri</b>				
UR20-4RO-SSR-255	4 DO Solid State Röle, 0.5A/ kontak	1315540000	127,00 €	1
UR20-4RO-CO-255	4 DO Change Over Röle, 6A/ kontak 277V AC/DC	1315550000	120,00 €	1
<b>Analog Input Modülleri</b>				
Voltaj (0...5 V, ±5 V, 0...10 V, ±10 V, 1...5 V, 2...10 V), Akım (0...20 mA, 4...20 mA)				
UR20-4AI-UI-16	4 AI Modülü (2, 3, 3 + FE kablolu), 16 Bit	1315620000	225,00 €	1
UR20-4AI-UI-16-DIAG	4 AI Modülü (2, 3, 3 + FE kablolu), 16 Bit, diagnosis	1315690000	250,00 €	1
UR20-4AI-UI-16-HD	4 AI HD Modülü (2, 3, 3 + FE kablolu), 16 Bit	1506920000	225,00 €	1
UR20-4AI-UI-16-DIAG-HD	4 AI HD Modülü (2, 3, 3 + FE kablolu), 16 Bit, diagnosis	1506910000	250,00 €	1
UR20-4AI-UI-12	4 AI Modülü (2, 3, 3 + FE kablolu), 12 Bit	1394390000	200,00 €	1
* UR20-4AI-UI-DIF-16-DIAG	4 AI Modülü, Diferansiyel giriş, 16 Bit, diagnosis	1993880000	200,00 €	1
Akım (0 – 20 mA, 4 – 20 mA)				
* UR20-4AI-HART-16-DIAG	4 AI Modülü, HART Protokollü, 16 Bit, diagnosis	2617520000	225,00 €	1
Voltaj (0...5 V, ±5 V, 0...10 V, ±10 V, 1...5 V, 2...10 V), Akım (0...20 mA, 4...20 mA)				
* UR20-4AI-UHISO-16-DIAG	4 AI Modülü (2, 3, 3 + FE kablolu), 16 Bit, İzolasyonlu, diagnosis	2566960000	250,00 €	1
Akım (0 – 20 mA, 4 – 20 mA)				
UR20-8AI-PLC-INT	8 AI Modülü (PLC Interface), 16 Bit	1315670000	235,00 €	1
UR20-8AI-16-HD	8 AI HD Modülü, 16 Bit	1315650000	234,00 €	1
UR20-8AI-16-DIAG-HD	8 AI HD Modülü, 16 Bit, diagnosis	1315720000	265,00 €	1
<b>Analog Output Modülü</b>				
Voltaj (0...5 V, ±5 V, 0...10 V, ±10 V, 1...5 V, 2...10 V), Akım (0...20 mA, 4...20mA)				
* UR20-2AO-UHISO-16-DIAG	2 AO Modülü (2 kablolu) 16 Bit, İzolasyonlu, diagnosis	2566970000	410,00 €	1
UR20-4AO-UI-16	4 AO Modülü (2 ve 4 kablolu), 16 Bit	1315680000	260,00 €	1
UR20-4AO-UI-16-DIAG	4 AO Modülü (2 ve 4 kablolu), 16 Bit, diagnosis	1315730000	285,00 €	1
* UR20-4AO-UI-16 M	4 AO Modülü, Marine Sertifikalı, 16 Bit	2453880000	304,00 €	1
* UR20-4AO-UI-16-M-DIAG	4 AO Modülü, Marine Sertifikalı, 16 Bit, diagnosis	2453870000	323,00 €	1
<b>Not:</b> HD modüllere ait olan konnektörleri ayrı şekilde sipariş edilmelidir.				
<b>Load Cell Modülü</b>				
UR20-2AI-SG-24-DIAG	Load Cell modülü 2 kanal	1990070000	295,00 €	1
<b>Step Motor Modülü</b>				
UR20-1SM-50W-6DI2DO-P	6 DI( 2 kanal Enkoder için) ve 2 DO (50W uygulamalara kadar)	2489830000	404,00 €	1
<b>Enerji İzleme Modülü</b>				
UR20-3EM-230V-AC	1 / 5 A 3 faz enerji izleme modülü (Aktif, reaktif güç, 31. Harmonik)	2007420000	250,00 €	1
<b>Emniyet I/O Modülleri</b>				
UR20-PF-0-1DI-SIL	24V SIL 3 Emniyet I/O Modülü. 1 acil stop butonu için 1 DI	1335030000	270,00 €	1



UR20-4DI-4DO-PN-FSPS-V2



UR20-8DI-PN-FSPS-V2



UR20-1SSI



UR20-4AI-RTD-HP-DIAG



UR20-4AI-R-HS-16-DIAG



UR20-16AUX-I



UR20-PG0.35

Tip	Açıklama	Sipariş No	Fiyat/Birim	Ambalaj
UR20-PF-0-2DI-DELAY-SIL	24V SIL 3 Emniyet I/O Modülü. 2 acil stop butonu için 2 DI(Zaman gecikme fonksiyonlu)	1335040000	300,00 €	1
UR20-PF-0-2DI-SIL	24V SIL 3 Emniyet I/O Modülü. 2 acil stop butonu için 2 DI	1335050000	280,00 €	1
* UR20-4DI-4DO-PN-FSOE-V2	24V SIL 3 4DI + 4DO EtherCAT Emniyet I/O modülü	2464580000	300,00 €	1
* UR20-4DI-4DO-PN-FSPS-V2	24V SIL 3 4DI + 4DO PROFI-safe Emniyet I/O modülü	2464570000	310,00 €	1

#### Emniyet I/O Modülleri

* UR20-8DI-PN-FSOE-V2	24V SIL 3 8DI EtherCAT Emniyet I/O modülü	2464600000	233,00 €	1
* UR20-8DI-PN-FSPS-V2	24V SIL 3 8DI PROFI-safe Emniyet I/O modülü	2464590000	260,00 €	1

#### Dijital Counter ve Pulse Modulation Modülleri

UR20-1CNT-100-1DO	1 Kanal Dijital Counter Modülü, 32 Bit 100Khz,Reset, Digital Output	1315570000	180,00 €	1
UR20-1CNT-500	1 Kanal Dijital Counter Modülü, 32 Bit 500Khz, Reset	1315580000	205,00 €	1
UR20-2CNT-100	2 Kanal Dijital Counter Modülü, 32 Bit 100Khz	1315590000	210,00 €	1
UR20-2FCNT-100	2 Kanal Dijital Frekans Counter Modülü, 32 Bit 100Khz	1508080000	200,00 €	1
UR20-2PWM-PN-0.5A	2 kanal PWM Modülü, 0.5A/ kanal Max 40 Khz	1315600000	210,00 €	1
UR20-2PWM-PN-2A	2 kanal PWM Modülü, 2A/ kanal Max 40 Khz	1315610000	250,00 €	1

#### Serial Arayüz ve Interface Modülleri

UR20-1SSI	SSI Encoder Modülü(Synchronous serial interface), 125kHz - 2MHz	1508090000	230,00 €	1
UR20-1COM-232-485-422	Seri Haberleşme Modülü (RS232, RS485, RS422)	1315750000	250,00 €	1
UR20-1COM-SAI-PRO	IP20 - IP67 Arayüz Haberleşme Modülü, SAI-PRO Subbus	2007430000	230,00 €	1
UR20-4COM-IO-LINK	IO-Link Master Modülü, 4 kanal	1315740000	240,00 €	1

#### Sıcaklık Algılama Modülleri

Sensör: Pt100, 200, 500, 1000; Ni100, 120, 200, 500, 1000; Cu10; 40 Ω - 4000 Ω aralık direnç giriş değeri

UR20-4AI-RTD-DIAG	4 AI RTD Sensör Bağlantı Modülü (2, 3, 4 kablolu), 16 Bit, diagnosis	1315700000	222,00 €	1
* UR20-4AI-RTD-HP-DIAG	4 AI RTD, Yüksek hassasiyetli uygulamalar, diagnosis	2456540000	250,00 €	1
UR20-8AI-RTD-DIAG-2W	8 AI RTD Sensör Bağlantı Modülü, 16 Bit	2555940000	265,00 €	1

Sensör: J, K, T, B, N, E, R, S, L, U, C, mV

UR20-4AI-TC-DIAG	4 AI TC Sensör Bağlantı Modülü, 16 Bit	1315710000	234,00 €	1
------------------	--	------------	----------	---

#### Potansiyometre Modülü

* UR20-4AI-R-HS-16-DIAG	4 AI modül, 16 Bit, diagnosis	2001670000	242,00 €	1
-------------------------	-------------------------------	------------	----------	---

#### Besleme Modülleri

UR20-PF-I	Besleme Modülü, 10A Input	1334710000	45,00 €	1
UR20-PF-O	Besleme Modülü, 10A Output	1334740000	45,00 €	1

#### AUX Besleme ve Potansiyel Dağıtım Modülleri

UR20-16AUX-I	Potansiyel Dağıtım Modülü, Input	1334770000	32,50 €	1
UR20-16AUX-O	Potansiyel Dağıtım Modülü, Output	1334780000	32,50 €	1
UR20-16AUX-FE	Potansiyel Dağıtım Modülü, Toprak	1334790000	32,50 €	1
UR20-16AUX-GND-I	Potansiyel Dağıtım Modülü, GND-I	1334800000	32,50 €	1
UR20-16AUX-GND-O	Potansiyel Dağıtım Modülü, GND-O	1334810000	32,50 €	1

#### Pasif Modül

UR20-ES	Boş Modül Yapısı	1315770000	27,00 €	1
---------	------------------	------------	---------	---

#### Aksesuarlar

UR20-EBK-ACC	Sonlandırma Plakaları	1346610000	12,00 €	5
DEK 5/8-11.5 MC NE WS	Modül Markalama	1341630000	1,01 TL	500
UR20-SM-ACC	Markalama Tutucu Aparat Opsiyonel	1339920000	1,50 €	20
UR20-PG0.35	HD Modüller için konnektör	1469340000	9,50 €	8

#### Montaj Yardımcı Aparatları

Multi-stripax 6-16	6, 10, 16 mm2 kesite sahip sert ve yumuşak izolasyonlu kablolar için	9202210000	5.741,00 TL	1
PWZ-UR20-HD		1525820000	2.337,00 TL	1

**Not:** HD modüllere ait olan konnektörleri ayrı şekilde sipariş edilmelidir.



UR67-PN-HP-8IOL-12-30M



UR67-MP-HP-16DI-12-60M



UR67-MP-HP-8DIDO-12-60M



UR67-PB-12-8DI-8-30K



SAI-AU M8 CAN 16DI/8DO

Tip	Açıklama	Sipariş No	Fiyat/Birim	Ambalaj
<b>u-remote IP 67</b>				
<b>IO-Link Modülleri</b>				
UR67-PN-HP-8IOL-12-30M	4 Typ A ve 4 Typ B Port, 8 DI veya 8 DO programlanabilir, (M12)	2426250000	550,00 €	1
UR67-PN-HP-8IOL-12-60M	4 Typ A ve 4 Typ B Port, 8 DI veya 8 DO programlanabilir, (M12)	2426260000	700,00 €	1
<b>Multiprotocol Modülleri (PROFINET/EtherNet/IP)</b>				
<b>Güç Kaynağı Bağlantısı : M12, L-coded (16 A)</b>				
UR67-MP-HP-16DI-12-60M	16 DI, (M12)	2426270000	527,00 €	1
UR67-MP-HP-16DO-12-60M	16 DO, (M12)	2426280000	560,00 €	1
UR67-MP-HP-8DIDO-12-60M	8 DI, 8 DO, (M12)	2426290000	570,00 €	1
<b>Güç Kaynağı Bağlantısı : 7/8", 5-pole</b>				
UR67-MP-78-8DIDO-12-60M	8 DI, 8 DO, (M12)	2426320000	700,00 €	1
UR67-MP-78-16DI-12-60M	16 DI, (M12)	2426300000	530,00 €	1
UR67-MP-78-16DO-12-60M	16 DO, (M12)	2426310000	700,00 €	1
<b>PROFIBUS-DP Modülleri</b>				
<b>Güç Kaynağı Bağlantısı : M12, 5-pole, A-coded</b>				
UR67-PB-12-8DI-8-30K	8 DI, (M8)	2426360000	407,00 €	1
UR67-PB-12-8DIO-8-30K	8 programlanabilir universal port (M8)	2426330000	440,00 €	1
<b>Güç Kaynağı Bağlantısı : 7/8", 5-pole</b>				
UR67-PB-78-16DI-12-60K	16 DI, (M12)	2426370000	487,00 €	1
UR67-PB-78-16DIO-12-60K	16 programlanabilir universal port (M12)	2426340000	553,00 €	1
UR67-PB-78-16DI-12-60M	16 DI, (M12)	2426390000	700,00 €	1
UR67-PB-78-16DO-12-60M	16 DO, (M12)	2426400000	540,00 €	1
UR67-PB-78-8DIDO-12-60M	8 DI, 8 DO, (M12)	2426380000	560,00 €	1
<b>CANopen Modülleri</b>				
<b>Güç Kaynağı Bağlantısı : M12, 5-pole, A-coded</b>				
SAI-AU M8 CAN 16DI/8DO	16DI, 8 DO programlanabilir, (M8)	1906690000	579,00 €	1
SAI-AU M12 CAN 16DI/8DO	16DI, 8 DO programlanabilir, (M12)	1906660000	517,00 €	1
SAI-AU M8 CAN 16DI	16 DI, (M8)	1906680000	501,00 €	1
SAI-AU M12 CAN 16DI	16 DI, (M12)	1906650000	496,00 €	1
SAI-AU M12 CAN AI/AO/DI	4 AI, 2 AO, 4 DI, (M12)	1906670000	859,00 €	1
<b>DeviceNet Modülleri</b>				
<b>Güç Kaynağı Bağlantısı : M12, 5-pole, A-coded</b>				
SAI-AU M8 DN 16DI	16 DI, (M8)	1906730000	558,00 €	1
SAI-AU M12 DN 16DI	16 DI, (M12)	1906700000	780,00 €	1
SAI-AU M8 DN 16DI/8DO	16DI, 8 DO programlanabilir, (M8)	1906740000	571,00 €	1
SAI-AU M12 DN 16DI/8DO	16DI, 8 DO programlanabilir, (M12)	1906710000	822,00 €	1
SAI-AU M12 DN AI/AO/DI	4 AI, 2 AO, 4 DI, (M12)	1906720000	920,00 €	1
SAI-AU M12 DN GW 16DI	16 DI, Subbus sistemi için Gateway modülü	1938570000	571,00 €	1



UV20-B-IPC-1000.01



UV20-B-IPC-2001.03



UV20-B-IPC-3000.01



UV66-BAS-7-IPPC-1001.01



UV66-ADV-12-IPPC-1001.01

Tip	Açıklama	Sipariş No	Fiyat/Birim	Ambalaj
<b>u-view Endüstriyel PC'ler</b>				
<b>Ultra Compact IPC 1000</b>				
UV20-B-IPC-1000.01	Intel® Atom® x5-E3930 Dual Core 1,30 GHz, up to 1,8 GHz boost, 2 GB DDR4 RAM, 60 GB SSD, İşletim sistemi yüklü değildir.	2676340000	1.785,00 €	1
UV20-B-IPC-1011.01	Intel® Atom® x7-E3950 Quad Core 1,60 GHz, up to 2,00 GHz boost, 4 GB DDR RAM, 60 GB SSD	2665800000	2.205,00 €	1
UV20-B-IPC-1011.02	Intel® Atom® x7-E3950 Quad Core 1,60 GHz, up to 2,00 GHz boost, 4 GB DDR RAM, 120 GB SSD	2676350000	2.268,00 €	1
UV20-B-IPC-10XX - DIN RAIL MOUNTING KIT	Ultra Compact Seri Ray Montaj Aparatı	2676710000	25,20 €	1

\* İşletim sistemi: Microsoft Windows 10 IoT Enterprise 2019 64bit

<b>Compact IPC 2000</b>				
UV20-B-IPC-2001.01	Intel Celeron J1900 Quad Core 2,0 GHz, up to 2,42 GHz boost, 4 GB DDR3 RAM, 60 GB SSD	2676370000	2.394,00 €	1
UV20-B-IPC-2001.02	Intel Celeron J1900 Quad Core 2,0 GHz, up to 2,42 GHz boost, 4 GB DDR3 RAM, 60 GB SSD, İşletim sistemi yüklü değildir.	2665810000	2.058,00 €	1
UV20-B-IPC-2001.03	Intel Celeron J1900 Quad Core 2,0 GHz, up to 2,42 GHz boost, 4 GB DDR3 RAM, 120 GB SSD	2676380000	2.541,00 €	1
UV20-B-IPC-20XX - DIN RAIL MOUNTING KIT	Compact Seri Ray Montaj Aparatı	2676720000	49,35 €	1

\* İşletim sistemi: Microsoft Windows 10 IoT Enterprise 2019 64bit

<b>Performant Serisi IPC 3000</b>				
UV20-B-IPC-3000.01	Intel® Celeron® 3955U 2,00 GHz, 4 GB DDR4 RAM, 60 GB SSD	2676390000	3.150,00 €	1
UV20-B-IPC-3010.01	Intel® Core® i3-6100U 2,30 GHz, 4 GB DDR4 RAM, 60 GB SSD	2676400000	3.843,00 €	1
UV20-B-IPC-3021.01	Intel® Core® i5-6300U 2,40 GHz, up to 3,00 GHz boost, 8 GB DDR4 RAM, 120 GB SSD	2676410000	4.788,00 €	1
UV20-B-IPC-3031.01	Intel Core i7-6600U 2,6GHz, up to 3,4GHz boost, 8 GB DDR4 RAM, 120 GB SSD	2665820000	5.775,00 €	1
UV20-B-IPC-3032.01	Intel Core i7-6600U 2,6GHz, up to 3,4GHz boost, 16 GB DDR4 RAM, 120 GB SSD İşletim sistemi yüklü değildir	2676420000	5.460,00 €	1

\* İşletim sistemi: Microsoft Windows 10 IoT Enterprise 2019 64bit

<b>u-view Endüstriyel Panel PC'ler</b>				
<b>Compact Panel PC - IPPC 1000 Serisi</b>				
UV66-BAS-7-IPPC-1001.01	7 inch Resistive Dokunmatik Ekran, Intel Celeron J1900 Quad Core 2,0 GHz, up to 2,42 GHz boost, 4 GB DDR4 RAM, 60 GB SSD	2676430000	2.520,00 €	1
UV66-ADV-7-IPPC-1001.01	7 inch Kapasitif Multi-touch Ekran, Intel Celeron J1900 Quad Core 2,0 GHz, up to 2,42 GHz boost, 4 GB DDR4 RAM, 60 GB SSD	2665830000	2.730,00 €	1
UV66-BAS-10-IPPC-1001.01	10,1 inch Resistive Dokunmatik Ekran, Intel Celeron J1900 Quad Core 2,0 GHz, up to 2,42 GHz boost, 4 GB DDR4 RAM, 60 GB SSD	2676450000	3.045,00 €	1
UV66-ADV-10-IPPC-1001.01	10,1 inch Kapasitif Multi-touch Ekran, Intel Celeron J1900 Quad Core 2,0 GHz, up to 2,42 GHz boost, 4 GB DDR4 RAM, 60 GB SSD	2676460000	3.360,00 €	1
UV66-BAS-12-IPPC-1001.01	12,1 inch Resistive Dokunmatik Ekran, Intel Celeron J1900 Quad Core 2,0 GHz, up to 2,42 GHz boost, 4 GB DDR4 RAM, 60 GB SSD	2676470000	3.255,00 €	1
UV66-ADV-12-IPPC-1001.01	12,1 inch Kapasitif Multi-touch Ekran, Intel Celeron J1900 Quad Core 2,0 GHz, up to 2,42 GHz boost, 4 GB DDR4 RAM, 60 GB SSD	2676480000	3.570,00 €	1
UV66-BAS-15-IPPC-1001.01	15,6 inch Resistive Dokunmatik Ekran, Intel Celeron J1900 Quad Core 2,0 GHz, up to 2,42 GHz boost, 4 GB DDR4 RAM, 60 GB SSD	2676490000	3.500,00 €	1
UV66-ADV-15-IPPC-1001.01	15,6 inch Kapasitif Multi-touch Ekran, Intel Celeron J1900 Quad Core 2,0 GHz, up to 2,42 GHz boost, 4 GB DDR4 RAM, 60 GB SSD	2676500000	3.780,00 €	1

\* İşletim sistemi: Microsoft Windows 10 IoT Enterprise 2019 64bit

<b>Performant Panel PC - IPPC 3000 Serisi</b>				
UV66-ADV-12-IPPC-3001.01	12,1 inch Kapasitif Multi-touch Ekran, Intel Celeron 3765U Dual Core 1,9 GHz, 4 GB DDR4 RAM, 60 GB SSD	2676510000	4.032,00 €	1

Serinin devamı sayfa 85



UV66-ADV-15-IPPC-3022.01

Tip	Açıklama	Sipariş No	Fiyat/Birim	Ambalaj
UV66-ADV-12-IPPC-3022.01	12,1 inch Kapasitif Multi-touch Ekran, Intel Core i5-5350U 1,8GHz, up to 2,9GHz boost, 8 GB DDR4 RAM, 120 GB SSD	2676520000	5.817,00 €	1
UV66-ADV-15-IPPC-3001.01	15,6 inch Kapasitif Multi-touch Ekran, Intel Celeron 3765U Dual Core 1,9 GHz, 4 GB DDR4 RAM, 60 GB SSD	2676530000	4.305,00 €	1
UV66-ADV-15-IPPC-3022.01	15,6 inch Kapasitif Multi-touch Ekran, Intel Core i5-5350U 1,8GHz, up to 2,9GHz boost, 8 GB DDR4 RAM, 120 GB SSD	2676540000	6.069,00 €	1
UV66-ADV-18-IPPC-3001.01	18,5 inch Kapasitif Multi-touch Ekran, Intel Celeron 3765U Dual Core 1,9 GHz, 4 GB DDR4 RAM, 60 GB SSD	2676550000	5.124,00 €	1
UV66-ADV-18-IPPC-3022.01	18,5 inch Kapasitif Multi-touch Ekran, Intel Core i5-5350U 1,8GHz, up to 2,9GHz boost, 8 GB DDR4 RAM, 120 GB SSD	2676560000	6.930,00 €	1
UV66-ADV-21-IPPC-3001.01	21,5 inch Kapasitif Multi-touch Ekran, Intel Celeron 3765U Dual Core 1,9 GHz, 4 GB DDR4 RAM, 60 GB SSD	2676570000	5.439,00 €	1
UV66-ADV-21-IPPC-3022.01	21,5 inch Kapasitif Multi-touch Ekran, Intel Core i5-5350U 1,8GHz, up to 2,9GHz boost, 8 GB DDR4 RAM, 120 GB SSD	2676580000	7.350,00 €	1

\* İşletim sistemi: Microsoft Windows 10 IoT Enterprise 2019 64bit

### u-view Endüstriyel Mönitörler

#### Endüstriyel Mönitörler - IPM 10 Serisi

UV66-ADV-10-IPM-10	10,1 inch Kapasitif Multi-touch Ekran	2676660000	2.121,00 €	1
UV66-ADV-12-IPM-10	12,1 inch Kapasitif Multi-touch Ekran	2676670000	2.247,00 €	1
UV66-ADV-15-IPM-10	15,6 inch Kapasitif Multi-touch Ekran	2676680000	2.415,00 €	1
UV66-ADV-18-IPM-10	18,5 inch Kapasitif Multi-touch Ekran	2676690000	3.150,00 €	1
UV66-ADV-21-IPM-10	21,5 inch Kapasitif Multi-touch Ekran	2676700000	3.654,00 €	1



UV66-ADV-12-IPM-10

### u-view HMI Paneller

#### HMI Paneller

UV66-ECO-4-RES-W	4,3 inch Resistive HMI Panel	2555660000	515,00 €	1
UV66-ECO-7-RES-W	7 inch Resistive HMI Panel	2555780000	680,00 €	1
UV66-ECO-10-RES-W	10,1 inch Resistive HMI Panel	2555790000	974,00 €	1

### SCADA Yazılımları

#### SCADA Tasarım Programı

* U-CREATE-PROCON-WEB-D-500	SCADA tasarım programı,500 tag	2705650000	2.280,00 €	1
* U-CREATE-PROCON-WEB-D-1000	SCADA tasarım programı,1.000 tag	2705660000	3.420,00 €	1
* U-CREATE-PROCON-WEB-D-2000	SCADA tasarım programı,2.000 tag	2705670000	4.560,00 €	1
* U-CREATE-PROCON-WEB-D-5000	SCADA tasarım programı,5.000 tag	2705680000	6.840,00 €	1
* U-CREATE-PROCON-WEB-D-10000	SCADA tasarım programı,10.000 tag	2705690000	8.436,00 €	1
* U-CREATE-PROCON-WEB-D-60000	SCADA tasarım programı,60.000 tag	2705710000	11.172,00 €	1
* U-CREATE-PROCON-WEB-D-PRO	SCADA tasarım programı, limitsiz tag	2705720000	17.100,00 €	1

#### SCADA Runtime Lisansı

* U-CREATE-PROCON-WEB-RT-500	SCADA runtime lisansı, 500 tag	2705740000	1.254,00 €	1
* U-CREATE-PROCON-WEB-RT-1000	SCADA runtime lisansı, 1.000 tag	2705750000	1.938,00 €	1
* U-CREATE-PROCON-WEB-RT-2000	SCADA runtime lisansı, 2.000 tag	2705760000	3.192,00 €	1
* U-CREATE-PROCON-WEB-RT-5000	SCADA runtime lisansı, 5.000 tag	2705770000	4.560,00 €	1
* U-CREATE-PROCON-WEB-RT-10000	SCADA runtime lisansı, 10.000 tag	2705780000	5.700,00 €	1
* U-CREATE-PROCON-WEB-RT-60000	SCADA runtime lisansı, 60.000 tag	2705800000	10.032,00 €	1
* U-CREATE-PROCON-WEB-RT-PRO	SCADA runtime lisansı, limitsiz tag	2705810000	15.048,00 €	1



UV66-ADV-21-IPM-10



## u-remote Yedek Parçaları

“İhtiyaç durumunda u-remote modüllerine ait olan yedek parçaları taban, elektronik modül ve konnektör girişleri şeklinde 3 farklı bileşen olarak ayrı ayrı sipariş edebilirsiniz.”



Ana Ürünler		Konnektör Parçaları-Ambalaj Adeti 5		Elektronik Kart Kısmı-Ambalaj Adeti 1		Taban Kısmı - Ambalaj adeti 5	
UR20-FBC-PB-DP	1334870000	UR20-PK-1334870000-SP	1361520000				
UR20-FBC-PN-HRT	1334880000	UR20-PK-1334880000-SP	1484120000				
UR20-FBC-EC	1334910000	UR20-PK-1334910000-SP	1484440000				
UR20-FBC-MOD	1334930000	UR20-PK-1334930000-SP	1484130000				
UR20-4DI-P	1315170000	UR20-PK-1315170000-SP	1346440000	UR20-EM-1315170000-SP	1346640000	UR20-BM-SP	1350930000
UR20-8DI-P-2W	1315180000	UR20-PK-1315180000-SP	1346430000	UR20-EM-1315080000-SP	1346650000	UR20-BM-SP	1350930000
UR20-8DI-P-3W	1394400000	UR20-PK-1394400000-SP	1411430000	UR20-EM-1394400000-SP	1434220000	UR20-BM-SP	1350930000
UR20-16DI-P	1315200000	UR20-PK-1315200000-SP	1346400000	UR20-EM-1315200000-SP	1346680000	UR20-BM-SP	1350930000
UR20-16DI-P-PLC-INT	1315210000	UR20-PK-1315210000-SP	1346590000	UR20-EM-1315210000-SP	1346690000	UR20-BM-SP	1350930000
UR20-2DI-P-TS	1460140000	UR20-PK-1460140000-SP	1484110000	UR20-EM-1460140000-SP	1463690000	UR20-BM-SP	1350930000
UR20-4DI-P-TS	1460150000	UR20-PK-1460150000-SP	1484430000	UR20-EM-1460150000-SP	1463680000	UR20-BM-SP	1350930000
UR20-4DO-P	1315220000	UR20-PK-1315220000-SP	1483960000	UR20-EM-1315220000-SP	1346700000	UR20-BM-SP	1350930000
UR20-4DO-P-2A	1315230000	UR20-PK-1315230000-SP	1483970000	UR20-EM-1315230000-SP	1346710000	UR20-BM-SP	1350930000
UR20-4DO-PN-2A	1394420000	UR20-PK-1394420000-SP	1483980000	UR20-EM-1394420000-SP	1480950000	UR20-BM-SP	1350930000
UR20-8DO-P	1315240000	UR20-PK-1315240000-SP	1346410000	UR20-EM-1315240000-SP	1346720000	UR20-BM-SP	1350930000
UR20-16DO-P	1315250000	UR20-PK-1315250000-SP	1483990000	UR20-EM-1315250000-SP	1346730000	UR20-BM-SP	1350930000
UR20-16DO-P-PLC-INT	1315270000	UR20-PK-1315270000-SP	1483940000	UR20-EM-1315270000-SP	1346740000	UR20-BM-SP	1350930000
UR20-4RO-SSR-255	1315540000	UR20-PK-1315540000-SP	1484000000	UR20-EM-1315540000-SP	1347120000	UR20-BM-SP	1350930000
UR20-4RO-CO-255	1315550000	UR20-PK-1315550000-SP	1346500000	UR20-EM-1315550000-SP	1347130000	UR20-BM-SP	1350930000
UR20-1CNT-100-1DO	1315570000	UR20-PK-1315570000-SP	1346520000	UR20-EM-1315570000-SP	1347140000	UR20-BM-SP	1350930000
UR20-2CNT-100	1315590000	UR20-PK-1315590000-SP	1346540000	UR20-EM-1315590000-SP	1347150000	UR20-BM-SP	1350930000
UR20-2PWM-PN-0.5A	1315600000	UR20-PK-1315600000-SP	1484010000	UR20-EM-1315600000-SP	1347180000	UR20-BM-SP	1350930000
UR20-2PWM-PN-2A	1315610000	UR20-PK-1315610000-SP	1346550000	UR20-EM-1315610000-SP	1347190000	UR20-BM-SP	1350930000
UR20-4AI-UI-16	1315620000	UR20-PK-1315620000-SP	1484020000	UR20-EM-1315620000-SP	1347200000	UR20-BM-SP	1350930000
UR20-4AI-UI-12	1394390000	UR20-PK-1394390000-SP	1484030000	UR20-EM-1394390000-SP	1434230000	UR20-BM-SP	1350930000
UR20-8AI-PLC-INT	1315670000	UR20-PK-1315670000-SP	1483950000	UR20-EM-1315670000-SP	1347250000	UR20-BM-SP	1350930000
UR20-4AI-TC-DIAG	1315710000	UR20-PK-1315710000-SP	1484050000	UR20-EM-1315710000-SP	1435740000	UR20-BM-SP	1350930000
UR20-4AI-RTD-DIAG	1315700000	UR20-PK-1315700000-SP	1484040000	UR20-EM-1315700000-SP	1347290000	UR20-BM-SP	1350930000
UR20-4AO-UI-16	1315680000	UR20-PK-1315680000-SP	1484070000	UR20-EM-1315680000-SP	1347270000	UR20-BM-SP	1350930000
UR20-PF-I	1334710000	UR20-PK-1334710000-SP	1346460000	UR20-EM-1334710000-SP	1347370000	UR20-BM-PF-I-SP	1350940000
UR20-PF-O	1334740000	UR20-PK-1334740000-SP	1346480000	UR20-EM-1334740000-SP	1347420000	UR20-BM-PF-O-SP	1350950000
UR20-PF-O-1DI-SIL	1335030000	UR20-PK-1335030000-SP	1346560000	UR20-EM-1335030000-SP	1347520000	UR20-BM-SIL-SP	1350970000
UR20-PF-O-2DI-SIL	1335050000	UR20-PK-1335050000-SP	1346570000	UR20-EM-1335050000-SP	1347540000	UR20-BM-SIL-SP	1350970000
UR20-PF-O-2DI-DELAY-SIL	1335040000	UR20-PK-1335040000-SP	1484100000	UR20-EM-1335040000-SP	1347530000	UR20-BM-SIL-SP	1350970000
UR20-16AUX-I	1334770000	UR20-PK-1334770000-SP	1346450000	UR20-EM-1334770000-SP	1347450000	UR20-BM-SP	1350930000
UR20-16AUX-O	1334780000	UR20-PK-1334780000-SP	1484080000	UR20-EM-1334780000-SP	1347470000	UR20-BM-SP	1350930000
UR20-16AUX-FE	1334790000	UR20-PK-1334790000-SP	1346490000	UR20-EM-1334790000-SP	1347480000	UR20-BM-SP	1350930000
UR20-16AUX-GND-I	1334800000	UR20-PK-1334800000-SP	1346470000	UR20-EM-1334800000-SP	1347490000	UR20-BM-SP	1350930000
UR20-16AUX-GND-O	1334810000	UR20-PK-1334810000-SP	1484090000	UR20-EM-1334810000-SP	1347500000	UR20-BM-SP	1350930000
UR20-ES	1315770000	UR20-PK-1315770000-SP	1346510000	UR20-EM-1315770000-SP	1347370000	UR20-BM-SP	1350930000

## SAI - Sensör Aktuatör Arayüzleri

SAI blokları sensör aktuatör sinyallerini sahada toplayarak PLC'ye aktarmaktan sorumludur. Bu kablolama ve servis masraflarını ve sürelerini azaltmak anlamına gelmektedir. Önceden hazırlanmış iletkenler ve M8/M12 konnektörlerle çalışıldığı için bağlantı hataları sıfıra indirilir. Weidmüller SAI bloklarının özellikleri şöyledir:

- Güvenilirlik
- Uzun vade de düşük maliyet
- Uzun ömürlülük
- Kısa arıza kaynaklı duruş süreleri

### SAI Pasif

Bu modüller 4, 6 ve 8 kanallı olarak, M8,M12 konnektörlü ve 3, 4 ve 5 kutuplu olacak şekilde tercih edilebilirler. Bloklar makina üzerine direkt olarak monte edilirler. İnce ve sağlamdırlar. IP 68 koruma sınıfında üretilirler.

- SAI-F, Dağıtıcısı SAI-4/6/8-F Entegre edilmiş kablolu versiyon.
- SAI-M, Dağıtıcısı SAI-4/6/8-M Kablosuz versiyon.

### SAI Aksesuarları

- Soketler ve fişler
- Sensör kabloları
- Markalama sistemleri
- El aletleri ve daha fazlası

### Fieldbus Elemanları

Özellikle patlayıcı ortamlarda kullanılan FBCon Fieldbus dağıtıcılarını kapsar. Endüstriyel uygulamalar için gerilim korumalı ve akım sınırlayıcılı versiyonları vardır.



## SAI - Sensör Aktuatör Arayüzler



SAI-4-F 4P PUR 3M



SAI-6-F 4P PUR 3M



SAI-8-F 4P PUR 3M



SAI-4-M 4P M12



SAI-6-M 4P M12

Tip	Kablo Uzunluğu	Konnektör Kutup Sayısı	Sipariş No	Fiyat/Birim	Ambalaj
-----	----------------	------------------------	------------	-------------	---------

### SAI Pasif Modüller ve Aksesuarları

#### SAI / Sensör-Aktuatör Arayüzleri - M12 - IP68 Hazır Kablolu

##### 4 - Kanal

SAI-4-F 4P PUR 3M	3 m	4-kutup	9456180000	98,65 €	1
SAI-4-F 4P PUR 5M	5 m	4-kutup	9456190000	80,80 €	1
SAI-4-F 4P PUR 10M	10 m	4-kutup	9456200000	87,75 €	1
SAI-4-F 4P PUR 15M	15 m	4-kutup	9456210000	141,00 €	1
SAI-4-F 4P PUR 20M	20 m	4-kutup	9456230000	187,00 €	1
SAI-4-F 5P PUR 3M	3 m	5-kutup	9456320000	108,00 €	1
SAI-4-F 5P PUR 5M	5 m	5-kutup	9456330000	103,00 €	1
SAI-4-F 5P PUR 10M	10 m	5-kutup	9456340000	140,00 €	1
SAI-4-F 5P PUR 15M	15 m	5-kutup	9456350000	165,00 €	1
SAI-4-F 5P PUR 20M	20 m	5-kutup	9456370000	235,00 €	1

##### 6 - Kanal

SAI-6-F 4P PUR 3M	3 m	4-kutup	9456460000	144,00 €	1
SAI-6-F 4P PUR 5M	5 m	4-kutup	9456470000	117,00 €	1
SAI-6-F 4P PUR 10M	10 m	4-kutup	9456480000	124,00 €	1
SAI-6-F 4P PUR 15M	15 m	4-kutup	9456490000	161,00 €	1
SAI-6-F 4P PUR 20M	20 m	4-kutup	9456510000	199,00 €	1
SAI-6-F 5P PUR 3M	3 m	5-kutup	9456600000	146,00 €	1
SAI-6-F 5P PUR 5M	5 m	5-kutup	9456610000	144,00 €	1
SAI-6-F 5P PUR 10M	10 m	5-kutup	9456620000	154,00 €	1
SAI-6-F 5P PUR 15M	15 m	5-kutup	9456630000	187,00 €	1
SAI-6-F 5P PUR 20M	20 m	5-kutup	9456650000	238,00 €	1

##### 8 - Kanal

SAI-8-F 4P PUR 3M	3 m	4-kutup	9456740000	149,00 €	1
SAI-8-F 4P PUR 5M	5 m	4-kutup	9456750000	120,00 €	1
SAI-8-F 4P PUR 10M	10 m	4-kutup	9456760000	121,00 €	1
SAI-8-F 4P PUR 15M	15 m	4-kutup	9456770000	177,00 €	1
SAI-8-F 4P PUR 20M	20 m	4-kutup	9456790000	238,00 €	1
SAI-8-F 5P PUR 3M	3 m	5-kutup	9456880000	157,00 €	1
SAI-8-F 5P PUR 5M	5 m	5-kutup	9456890000	140,00 €	1
SAI-8-F 5P PUR 10M	10 m	5-kutup	9456900000	190,00 €	1
SAI-8-F 5P PUR 15M	15 m	5-kutup	9456910000	258,00 €	1
SAI-8-F 5P PUR 20M	20 m	5-kutup	9456930000	258,00 €	1

Tip	Açıklama	Konnektör Kutup Sayısı	Sipariş No	Fiyat/Birim	Ambalaj
-----	----------	------------------------	------------	-------------	---------

### SAI Pasif Modüller ve Aksesuarları

#### SAI / Sensör-Aktuatör Arayüzleri - M12 - IP67

##### 4 - Kanal

SAI-4-M 4P M12	Komple Modül	4-kutup	1705920000	77,55 €	1
SAI-4-M 4P M12 UT	Ana Modül	4-kutup	1705921000	56,95 €	2
SAI-4-M 5P M12	Komple Modül	5-kutup	1701230000	80,00 €	1
SAI-4-M 5P M12 UT	Ana Modül	5-kutup	1701231000	67,70 €	2

##### 6 - Kanal

SAI-6-M 4P M12	Komple Modül	4-kutup	1705930000	92,90 €	1
SAI-6-M 4P M12 UT	Ana Modül	4-kutup	1705931000	100,00 €	2
SAI-6-M 5P M12	Komple Modül	5-kutup	1701240000	110,00 €	1
SAI-6-M 5P M12 UT	Ana Modül	5-kutup	1701241000	120,00 €	2



SAI-8-M 4P M12



SAI-4-F 3P M8 PUR 5M



SAI-8-F 3P M8 PUR 5M



SAI-4-F 3P M8 L 5M



SAI-8-F 3P M8 L 5M

Tip	Açıklama	Konnektör Kutup Sayısı	Sipariş No	Fiyat/Birim	Ambalaj
<b>8 - Kanal</b>					
SAI-8-M 4P M12	Komple Modül	4-kutup	1705940000	106,00 €	1
SAI-8-M 4P M12 UT	Ana Modül	4-kutup	1705941000	110,00 €	2
SAI-8-M 5P M12	Komple Modül	5-kutup	1701250000	110,00 €	1
SAI-8-M 5P M12 OL UT	Ana Modül	5-kutup	1740191000	116,00 €	2
<b>4/6/8 - Kanal Bağlantı Modülü</b>					
SAI-4/6/8-MH BLZF3.5	Yaylı Bağlantı Modülü		1752080000	36,85 €	1
SAI-4/6/8-MH BL3.5	Vidalı Bağlantı Modülü		1724750000	28,00 €	1

Tip	Kablo Uzunluğu	Konnektör Kutup Sayısı	Sipariş No	Fiyat/Birim	Ambalaj
-----	----------------	------------------------	------------	-------------	---------

**SAI Pasif Modüller ve Aksesuarları****SAI / Sensör-Aktuatör Arayüzleri - M8 - IP68 Hazır Kablolu**

Tip	Kablo Uzunluğu	Konnektör Kutup Sayısı	Sipariş No	Fiyat/Birim	Ambalaj
<b>4 - Kanal</b>					
SAI-4-F 3P M8 PUR 5M	5 Metre	3-kutup	1784640000	170,00 €	1
SAI-4-F 3P M8 PUR 10M	10 Metre	3-kutup	1784630000	290,00 €	1
SAI-4-F 4P M8 PUR 5M	5 Metre	4-kutup	1784600000	197,00 €	1
SAI-4-F 4P M8 PUR 10M	10 Metre	4-kutup	1784590000	214,00 €	1
<b>8 - Kanal</b>					
SAI-8-F 3P M8 PUR 5M	5 Metre	3-kutup	1784620000	173,00 €	1
SAI-8-F 3P M8 PUR 10M	10 Metre	3-kutup	1784610000	209,00 €	1
SAI-8-F 4P M8 PUR 5M	5 Metre	4-kutup	1784580000	203,00 €	1
SAI-8-F 4P M8 PUR 10M	10 Metre	4-kutup	1784570000	310,00 €	1

**SAI / Sensör-Aktuatör Arayüzleri - M8 - IP68**

Tip	Açıklama	Konnektör Kutup Sayısı	Sipariş No	Fiyat/Birim	Ambalaj
<b>4 - Kanal</b>					
SAI-4-M 3P M8	Komple Modül	3-kutup	1784680000	180,00 €	1
SAI-4-M 4P M8	Komple Modül	4-kutup	1784700000	192,00 €	1
<b>8 - Kanal</b>					
SAI-8-M 3P M8	Komple Modül	3-kutup	1784670000	162,00 €	1
SAI-8-M 4P M8	Komple Modül	4-kutup	1784690000	200,00 €	1

**SAI / Sensör-Aktuatör Arayüzleri - M8 - IP68 Hazır Kablolu**

Tip	Kablo Uzunluğu	Konnektör Kutup Sayısı	Sipariş No	Fiyat/Birim	Ambalaj
<b>4 - Kanal</b>					
SAI-4-F 3P M8 L 5M	5 Metre	3-kutup	1828720000	88,50 €	1
SAI-4-F 3P M8 L 10M	10 Metre	3-kutup	1828710000	119,00 €	1
SAI-4-F 4P M8 L 5M	5 Metre	4-kutup	1849680000	111,00 €	1
SAI-4-F 4P M8 L 10M	10 Metre	4-kutup	1849690000	180,00 €	1
<b>6 - Kanal</b>					
SAI-6-F 3P M8 L 5M	5 Metre	3-kutup	1828700000	142,00 €	1
SAI-6-F 3P M8 L 10M	10 Metre	3-kutup	1828690000	189,00 €	1
SAI-6-F 4P M8 L 5M	5 Metre	4-kutup	1849700000	193,00 €	1
SAI-6-F 4P M8 L 10M	10 Metre	4-kutup	1849670000	192,00 €	1
<b>8 - Kanal</b>					
SAI-8-F 3P M8 L 5M	5 Metre	3-kutup	1828680000	130,00 €	1
SAI-8-F 3P M8 L 10M	10 Metre	3-kutup	1828670000	150,00 €	1
SAI-8-F 4P M8 L 5M	5 Metre	4-kutup	1828620000	171,00 €	1
SAI-8-F 4P M8 L 10M	10 Metre	4-kutup	1828610000	207,00 €	1
<b>10 - Kanal</b>					
SAI-10-F 3P M8 L 5M	5 Metre	3-kutup	1828660000	208,00 €	1
SAI-10-F 3P M8 L 10M	10 Metre	3-kutup	1828650000	255,00 €	1
<b>12 - Kanal</b>					
SAI-12-F 3P M8 L 5M	5 Metre	3-kutup	1828640000	244,00 €	1
SAI-12-F 3P M8 L 10M	10 Metre	3-kutup	1828630000	298,00 €	1

## SAI - Sensör Aktuatör Arayüzler



SAIS-3/9



SAISW-3/9



SAISM 5/8S M12 5P B-COD



SAIS-M-5/8S M12 5P A-COD



SAISW-M-5/8 M12



SAISM-4/8S-M12 4P D-ZF



SAIS-M8-3P



SAISM-M8-3P-(IF)

Tip	Açıklama	Sipariş No	Fiyat/Birim	Ambalaj
<b>SAI Pasif Modüller ve Aksesuarları</b>				
<b>M12 Sensör Aktuatör Konektörleri (A-COD/ IP67)</b>				
SAIS-3/9	M12 Düz,Erkek, 3 Kutup PG 9	1021480000	11,00 €	1
SAIS-4/9	M12 Düz,Erkek, 4 Kutup PG 9	1807340000	9,50 €	1
SAISW-3/9	M12 Açılı ,Erkek , 3 Kutup PG9	1021290000	11,00 €	1
SAISW-4/9	M12 Açılı ,Erkek , 4 Kutup PG9	1807360000	11,75 €	1
SAIS-5/9	M12 Düz,Erkek, 5 Kutup PG 9	1807350000	9,90 €	1
SAISW- 5/9	M12 Açılı ,Erkek , 5 Kutup PG9	1807370000	15,00 €	1
SAIS-5/7-ZF	M12 Düz,Erkek 5 Kutup Yaylı Bağlantı PG7	1906390000	18,00 €	1
SAIS-8/9	M12 Düz,Erkek, 8 Kutup PG 9	1836970000	28,00 €	1
SAIB-3/9	M12 Düz,Dişi,3 Kutup PG9	1021510000	11,20 €	1
SAIB-4/9	M12 Düz,Dişi,4 Kutup PG9	1807230000	9,90 €	1
SAIBW-3/9	M12 Açılı,Dişi,3 Kutup PG9	1021320000	11,20 €	1
SAIBW-4/9	M12 Açılı,Dişi,4 Kutup PG9	1807240000	12,00 €	1
SAIB-5/9	M12 Düz,Dişi,5 Kutup PG9	1807250000	13,00 €	1
SAIBW-5/9	M12 Açılı,Dişi,5 Kutup PG9	1807330000	14,00 €	1
SAIB-5/7-ZF	M12 Düz, Dişi 5 Kutup Yaylı Bağlantı PG7	1924970000	17,60 €	1
<b>Not: PG7 Kablo girişli ürünler için Lütfen irtibat kurunuz</b>				
<b>M12 Sensör Aktuatör Konektörleri (Profibus için / B-COD) Metal</b>				
SAISM 5/8S M12 5P B-COD	M12 Düz,Erkek,5 Kutuplu PG 9 -Metal EMC(IP67)	1784790000	26,00 €	1
SAIBM 5/8S M12 5P B-COD	M12 Düz,Dişi,5 Kutuplu PG 9 -Metal EMC(IP67)	1784780000	26,00 €	1
SAIS-3-IDC-M12B-COD	M12 Düz, Erkek,3 Kutuplu PG 9 -Metal EMC(IP67)	1864730000	34,95 €	1
SAIB-3-IDC-M12B-COD	M12 Düz,Dişi,3 Kutuplu PG 9 -Metal EMC(IP67)	1864740000	36,00 €	1
SAISW-M-5/8 M12 B-COD	M12 Açılı ,Erkek , 5 Kutup PG9	1944570000	34,95 €	1
SAIBW-M-5/8 M12 B-COD	M12 Açılı ,Dişi,5 Kutup PG9	1944580000	35,20 €	1
SAIS 5/9-VA-B-COD	M12 Düz, Erkek,5 Kutuplu PG9 -Paslanmaz Çelik(IP 69K)	1920720000	77,00 €	1
SAIB 5/9-VA-B-COD	M12 Düz,Dişi,5 Kutuplu PG9 - Paslanmaz Çelik(IP69K)	1920730000	63,75 €	1
<b>M12 Sensör Aktuatör Konektörleri (A-COD) Metal</b>				
SAIS-M-5/8S M12 5P A-COD	M12 Düz,Erkek 5 Kutuplu (IP67) PG9	1784740000	24,00 €	1
SAIB-M-5/8S M12 5P A-COD	M12 Düz,Dişi 5 Kutuplu (IP67) PG9	1784750000	24,00 €	1
SAISW-M-5/8 M12	M12 Açılı Erkek 5 Kutuplu (IP67) PG9	1803940000	32,00 €	1
SAIBW-M-5/8 M12	M12 Açılı Dişi 5 Kutuplu (IP67) PG9	1803920000	26,15 €	1
SAIS 5/9-VA	M12 Düz,Erkek 5 Kutuplu Yaylı Bağlantı (IP69K)	1920700000	77,00 €	1
SAIB 5/9-VA	M12 Düz,Dişi 5 Kutuplu Yaylı Bağlantı (IP69K)	1920710000	59,20 €	1
<b>M12 Sensör Aktuatör Konektörleri Endüstriyel Ethernet(D-COD) Metal</b>				
SAISM-4/8S-M12-4P D-COD	M12 Düz,Erkek 4 Kutuplu (IP67)	1892120000	22,00 €	1
SAIBM-4/8S-M12-4P D-COD	M12 Düz,Dişi 4 Kutuplu (IP67)	1892130000	19,00 €	1
SAISM-4/8S-M12 4P D-ZF	M12 Düz,Erkek 4 Kutuplu (IP67)	1892120001	32,20 €	1
SAIBM-4/8S-M12 4P D-ZF	M12 Düz,Dişi 4 Kutuplu,Yaylı Bağlantı (IP67)	1892130001	42,00 €	1
SAISW-4/8S-M12 4P D-ZF	M12 Açılı,Erkek 4 Kutuplu,Yaylı Bağlantı (IP67)	1803930001	34,15 €	1
SAIBW-4/8S-M12 4P D-ZF	M12 Açılı,Erkek 4 Kutuplu,Yaylı Bağlantı (IP67)	1139330000	34,40 €	1
<b>Sensör Aktuatör Konektörleri (M8 PLASTİK)</b>				
SAIS-M8-3P	M8 Düz,Erkek, 3 Kutup	1803860000	14,00 €	1
SAIS-M8-4P	M8 Düz,Erkek, 4 Kutup	1803850000	14,35 €	1
SAIB-M8-3P	M8 Düz,Dişi, ,3 Kutup	1803870000	12,00 €	1
SAIB-M8-4P	M8 Düz,Dişi , 4 Kutup	1803880000	14,35 €	1
<b>Sensör Aktuatör Konektörleri (M8 METAL)</b>				
SAISM-M8-3P-(IF)	M8 Düz,Erkek, 3 Kutup	1010060000	30,00 €	1
SAISM-M8-4P-(IF)	M8 Düz,Erkek, 4 Kutup	1010070000	26,00 €	1
SAIBM-M8-3P-(IF)	M8 Düz ,Dişi , 3 Kutup	1010080000	30,00 €	1
SAIBM-M8-4P-(IF)	M8 Düz ,Dişi , 4 Kutup	1010090000	26,00 €	1



SAIS-4-IDC M12 small



SAI-Y-5S B2-4 2M12



Screwty Set



PB-DP SUB-D M12 TERM

Tip	Açıklama	Sipariş No	Fiyat/Birim	Ambalaj
<b>Sensör Aktuatör Konektörleri (IDC)</b>				
SAIS-4-IDC M12 small	M12 Düz,Erkek, 4 Kutup	1781550001	14,00 €	1
SAIB-4-IDC-M12 small	M12 Düz,Dişi, 4 Kutup	1781540001	12,40 €	1
SAISW-4-IDC M12	M12 Açılı,Erkek, 4 Kutup	1812870000	22,95 €	1
SAIBW-4-IDC M12	M12 Açılı,Dişi, 4 Kutup	1812890000	23,20 €	1
SAIS-3-IDC M8 small	M8 Düz,Erkek, 3 Kutup	1784040001	11,40 €	1
SAIS-4-IDC M8 small	M8 Düz,Erkek, 4 Kutup	1784060001	14,40 €	1
SAIB-3-IDC-M8 small	M8 Düz,Dişi, 3 Kutup	1784030001	12,95 €	1
SAIB-4-IDC-M8 small	M8 Düz,Dişi, 4 Kutup	1784050001	14,00 €	1

<b>Dağıtıcı T Konektörler</b>				
SAI-Y-5S B2-4 2M12	Distribution, Pin 2 + 4 Bridged	1783410000	23,05 €	1
SAI-Y-5S PARA 2M12	Parallel Distribution	1783430000	23,05 €	1
SAI-Y-5S- M12/M12	Individual Distribution	1826880000	30,00 €	1
SAI-Y-4-4/2-4 M12/8	Individual Distribution	1783420000	23,05 €	1

<b>Yardımcı El Aleti</b>				
Screwty Set	Konektör Sıkma El Aleti	1910000000	2.677,00 TL	1

Tip	Açıklama	Ölçü	Sipariş No	Fiyat/Birim	Ambalaj
<b>SAI Pasif Modüller ve Aksesuarları</b>					
<b>Aksesuar</b>					
SAI-SK-M12	SAI M12 Kapak	M12	9456050000	0,55 €	30
SAI-SK M8	SAI M8 Kapak	M8	1802760000	2,00 €	50
SAI-SK M5	SAI M5 Kapak	M5	1855310000	2,60 €	50
SAI-SK-M12-UNI	SAI M12 Kapak	M12 Universal	2330260000	3,00 €	20
ESG 9/20 MC NE WS	Beyaz		1609940000	2,54 TL	200

Tip	Ölçü	Açıklama	Sipariş No	Fiyat/Birim	Ambalaj
<b>SAI Pasif Modüller ve Aksesuarları</b>					
<b>Hazır Bus Kablolar</b>					
SAIL-M8GM8G-4S-0.15U-SB	15 cm	Düz M8 erkek-dişi	1981900015	30,80 €	1
SAIL-M8GM8G-4S-0.3U-SB	30 cm	Düz M8 erkek-dişi	1981900030	32,55 €	1
SAIL-M8GM8G-4S-1.0U-SB	1 m	Düz M8 erkek-dişi	1981900100	32,80 €	1
SAIL-M8GM8G-4S-1.5U-SB	1,5 m	Düz M8 erkek-dişi	1981900150	37,35 €	1
SAIL-M8GM8G-4S-3.0U-SB	3 m	Düz M8 erkek-dişi	1981900300	53,00 €	1
SAIL-M8GM8G-4S-5.0U-SB	5 m	Düz M8 erkek-dişi	1981900500	52,55 €	1
SAIL-M8GM8G-4S-10U-SB	10 m	Düz M8 erkek-dişi	1981901000	72,95 €	1

Tip	Koruma Sınıfı	Sipariş No	Fiyat/Birim	Ambalaj
<b>SAI Pasif Modüller ve Aksesuarları</b>				
<b>Profibus DP Sub D Konektörler</b>				
PB-DP SUB-D M12 TERM	IP30	1140650000	84,15 €	1
PB-DP SUB-D M12 TERM PS	IP30	1140640000	90,10 €	1
PB-DP SUB-D ZF35TERM	IP30	1173220000	72,90 €	1
PB-DP SUB-D ZF35TERM PS	IP30	1173240000	80,00 €	1
PB-DP SUB-D ZF TERM	IP30	1161870000	72,90 €	1
PB-DP SUB-D ZF TERM PS	IP30	1161880000	79,50 €	1



## Endüstriyel Ethernet

Endüstriyel ethernet network teknolojisinde günden güne öne çıkan bir standart haline gelmektedir. Çünkü planlama ve üretim aşamasında bu uygulamalardan alınan verim daha fazladır. Üreticiler network ağlarıyla tesisleri birbirine entegre edebilmektedir.

Birçok uygulama haberleşme standartları, yazılımlar, ve protokoller ile belirleniyorsa da, bir network'ün fiziksel yapısının tamamen güvenilir bir şekilde çalışması gerekir. Çünkü endüstride hataların %80'inden fazlası bağlantı hatalarıdır. Örneğin; kablo kırılması vb.

Weidmüller, size uzun ömürlü, bakım gerektirmeyen elektrik bağlantılarını geleneksel ürünlerin yanında yenilikçi ürünlerini de önermektedir. Bu ürünler kontrolörlerden saha bağlantılarına kadar bir çok çeşiti kapsar.

## STEADYTEC Teknolojili IE-LINE

Modüler yapısı sayesinde maksimum esneklik sağlar. IP 67 koruma mümkündür.

Endüstriyel alandaki avantajları şunlardır:

- Hızlı
- Güvenli
- Çözüm Odaklı
- Pratik







IE-SW-BL05-5TX



IE-SW-BL08-7TX-1SC



IE-SW-VL16T-16TX



IE-SW-VL08T-8GT



IE-SW-BL06T-2TX-4POE



IE-SW-BL05-1GT-4GTPOE

Tip	Açıklama	Sipariş No	Fiyat/Birim	Ambalaj
<b>Unmanaged - Yönetilemeyen Ethernet Switchler</b>				
IE-SW-BL05-5TX	5 x RJ45	1240840000	165,00 €	1
IE-SW-BL05T-5TX	5 x RJ45 (-40 ... +75 °C)	1240850000	186,00 €	1
IE-SW-BL05-4TX-1SC	4 x RJ45, 1 x SC Multi-mode	1240890000	280,00 €	1
IE-SW-BL05T-4TX-1SC	4 x RJ45, 1 x SC Multi-mode (-40 ... +75 °C)	1286550000	317,00 €	1
IE-SW-BL05-4TX-1ST	4 x RJ45, 1 x ST Multi-mode	1240880000	320,00 €	1
IE-SW-BL05T-4TX-1ST	4 x RJ45, 1 x ST Multi-mode (-40 ... +75 °C)	1286540000	317,00 €	1
IE-SW-BL05-4TX-1SCS	4 x RJ45, 1 x SC Single-mode	1240870000	459,00 €	1
IE-SW-BL05T-4TX-1SCS	4 x RJ45, 1 x SC Single-mode (-40 ... +75 °C)	1286530000	529,00 €	1
IE-SW-BL08-8TX	8 x RJ45	1240900000	210,00 €	1
IE-SW-BL08T-8TX	8x RJ45, (-40 ... +75 °C)	1286560000	290,00 €	1
IE-SW-BL08-7TX-1ST	7x RJ45, 1 x ST Multi-mode	1412090000	380,00 €	1
IE-SW-BL08-7TX-1SC	7x RJ45, 1 x SC Multi-mode	1412070000	380,00 €	1
IE-SW-BL08T-7TX-1SC	7x RJ45, 1 x SC Multi-mode (-40 ... +75 °C)	1412080000	430,00 €	1
IE-SW-BL08T-7TX-1ST	7x RJ45, 1 x ST Multi-mode (-40 ... +75 °C)	1412100000	430,00 €	1
IE-SW-BL08-7TX-1SCS	7x RJ45, 1 x SC Single-mode	1240950000	515,00 €	1
IE-SW-BL08T-7TX-1SCS	7x RJ45, 1 x SC Single-mode (-40 ... +75 °C)	1286580000	602,00 €	1
IE-SW-BL08-6TX-2ST	6x RJ45, 2 x ST Multi-mode	1240930000	479,00 €	1
IE-SW-BL08-6TX-2SC	6 x RJ45, 2 x SC Multi-mode	1240910000	550,00 €	1
IE-SW-BL08T-6TX-2SC	6 x RJ45, 2 x SC Multi-mode (-40 ... +75 °C)	1240920000	524,00 €	1
IE-SW-BL08T-6TX-2ST	6 x RJ45, 2 x ST Multi-mode (-40 ... +75 °C)	1286570000	533,00 €	1
IE-SW-BL08-6TX-2SCS	6 x RJ45, 2 x SC Single-mode	1412110000	708,00 €	1
IE-SW-BL08T-6TX-2SCS	6 x RJ45, 2 x SC Single-mode (-40 ... +75 °C)	1412120000	1.000,00 €	1
IE-SW-VL16-16TX	16 x RJ45	1241000000	970,00 €	1
IE-SW-VL16T-16TX	16 x RJ45 (-40 ... +75 °C)	1286590000	1.100,00 €	1
IE-SW-VL09T-6TX-3SC	6 x RJ45, 3 x SC Multi-mode (-40 ... +75 °C)	1240980000	988,00 €	1
IE-SW-VL16-14TX-2SC	14 x RJ45, 2 x SC Multi-mode	1241030000	1.069,00 €	1
IE-SW-VL16-14TX-2ST	14 x RJ45, 2 x ST Multi-mode	1241050000	1.069,00 €	1
IE-SW-VL16T-14TX-2SC	14 x RJ45, 2 x SC Multi-mode (-40 ... +75 °C)	1286610000	1.292,00 €	1
IE-SW-VL16T-14TX-2ST	14 x RJ45, 2 x ST Multi-mode (-40 ... +75 °C)	1286620000	1.600,00 €	1
<b>Gigabit Unmanaged - Yönetilemeyen Ethernet Switchler</b>				
IE-SW-BL05-4GT-1GS	4 * RJ45 10/100/1000BaseT(X), 1 x combo-port	2435400000	400,00 €	1
IE-SW-VL08-8GT	8 x RJ45 10/100/1000BaseT(X)	1241270000	700,00 €	1
IE-SW-VL08T-8GT	8 x RJ45 10/100/1000BaseT(X) (-40 ... +75 °C)	1286860000	850,00 €	1
IE-SW-VL08-6GT-2GS	6 x RJ45 10/100/1000BaseT(X), 2 x combo-ports	1241280000	786,00 €	1
IE-SW-VL08T-6GT-2GS	6 x RJ45 10/100/1000BaseT(X), 2 x combo-ports (-40 ... +75 °C)	1286870000	847,00 €	1
<b>POE Unmanaged - Yönetilemeyen Switchler</b>				
<b>Fast Ethernet POE</b>				
IE-SW-BL06-2TX-4POE	2 x RJ45, 4 x RJ45 PoE	1241380000	507,00 €	1
IE-SW-BL06T-2TX-4POE	2 x RJ45, 4 x RJ45 PoE (-40 ... +75 °C)	1286920000	609,00 €	1
IE-SW-BL06-1TX-4POE-1SC	1 x RJ45, 4 x RJ45 PoE+, 1 x SC Multi-mode	1504250000	805,00 €	1
IE-SW-BL06T-1TX-4POE-1SC	1 x RJ45, 4 x RJ45 PoE+, 1 x SC Multi-mode (-40 ... +75 °C)	1504260000	933,00 €	1
IE-SW-BL06-1TX-4POE-1ST	1 x RJ45, 4 x RJ45 PoE+, 1 x ST Multi-mode	1504270000	805,00 €	1
IE-SW-BL06T-1TX-4POE-1ST	1 x RJ45, 4 x RJ45 PoE+, 1 x ST Multi-mode (-40 ... +75 °C)	1504290000	933,00 €	1
IE-SW-BL06-4POE-2SC	4 x RJ45 PoE+, 2 x SC Multi-mode	1504210000	958,00 €	1
IE-SW-BL06T-4POE-2SC	4 x RJ45 PoE+, 2 x SC Multi-mode (-40 ... +75 °C)	1504220000	1.110,00 €	1
IE-SW-BL06-4POE-2ST	4 x RJ45 PoE+, 2 x ST Multi-mode	1504230000	958,00 €	1
IE-SW-BL06T-4POE-2ST	4 x RJ45 PoE+, 2 x ST Multi-mode (-40 ... +75 °C)	1504240000	1.110,00 €	1
<b>Gigabit POE</b>				
IE-SW-BL05-1GT-4GTPOE	4 x RJ45 PoE+, 1 x RJ45 10/100/1000BaseT(X)	1504320000	1.062,00 €	1
IE-SW-BL05T-1GT-4GTPOE	4 x RJ45 10/100/1000BaseT(X) PoE+, 1 x RJ45 10/100/1000BaseT(X)(-40 ... +75 °C)	1504340000	1.232,00 €	1

Serinin devamı sayfa 95

Tip	Açıklama	Sipariş No	Fiyat/Birim	Ambalaj
IE-SW-BL05-1GS-4GTPOE	4 x RJ45 10/100/1000BaseT(X) PoE+, 1 x Slot 1000BaseSFP	1504360000	1.132,00 €	1
IE-SW-BL05T-1GS-4GTPOE	4 x RJ45 10/100/1000BaseT(X) PoE+, 1 x Slot 1000BaseSFP (-40 ...+75 °C)	1504380000	1.314,00 €	1
<b>Managed - Yönetilen Ethernet Switchler</b>				
IE-SW-VL05M-5TX	5 x RJ45	1504280000	620,00 €	1
IE-SW-VL05MT-5TX	5 x RJ45 (-40 ...+75 °C)	1504310000	625,00 €	1
IE-SW-VL08MT-8TX	8x RJ45 (-40 ...+75 °C)	1240940000	1.050,00 €	1
IE-SW-VL05M-3TX-2SC	3 x RJ45, 2 x SC Multi-mode	1504330000	1.025,00 €	1
IE-SW-VL05M-3TX-2ST	3 x RJ45, 2 x ST Multi-mode	1504370000	1.025,00 €	1
IE-SW-VL05MT-3TX-2SC	3 x RJ45, 2 x SC Multi-mode (-40 ...+75 °C)	1504350000	1.127,00 €	1
IE-SW-VL05MT-3TX-2ST	3 x RJ45, 2 x ST Multi-mode (-40 ...+75 °C)	1504390000	1.127,00 €	1
IE-SW-VL08MT-5TX-3SC	5 x RJ45, 3 x SC Multi-mode (-40 ...+75 °C)	1240970000	2.170,00 €	1
IE-SW-VL08MT-6TX-2ST	6 x RJ45, 2 x ST Multi-mode (-40 ...+75 °C)	1240990000	1.363,00 €	1
IE-SW-VL08MT-6TX-2SC	6 x RJ45, 2 x SC Multi-mode (-40 ...+75 °C)	1344770000	1.419,00 €	1
IE-SW-VL08MT-6TX-2SCS	6 x RJ45, 2 x SC Single-mode (-40 ...+75 °C)	1241020000	2.700,00 €	1
IE-SW-VL08MT-5TX-1SC-2SCS	5 x RJ45, 1 x SC Multi-mode, 2 x SC Single-mode (-40 ...+75 °C)	1345240000	2.122,00 €	1
IE-SW-PL08M-8TX	8 x RJ45	1241040000	1.370,00 €	1
IE-SW-PL08MT-8TX	8 x RJ45 (-40 ...+75 °C)	1286780000	1.318,00 €	1
IE-SW-PL08M-6TX-2SC	6 x RJ45, 2 x SC Multi-mode	1241070000	2.100,00 €	1
IE-SW-PL08MT-6TX-2SC	6 x RJ45, 2 x SC Multi-mode (-40 ...+75 °C)	1286790000	2.006,00 €	1
IE-SW-PL08M-6TX-2ST	6 x RJ45, 2 x ST Multi-mode	1241080000	2.100,00 €	1
IE-SW-PL08MT-6TX-2ST	6 x RJ45, 2 x ST Multi-mode (-40 ...+75 °C)	1286800000	2.006,00 €	1
IE-SW-PL08M-6TX-2SCS	6 x RJ45, 2 x SC Single-mode	1241090000	2.750,00 €	1
IE-SW-PL08MT-6TX-2SCS	6 x RJ45, 2 x SC Single-mode (-40 ...+75 °C)	1286810000	2.559,00 €	1
IE-SW-PL16M-16TX	16 x RJ45	1241100000	2.500,00 €	1
IE-SW-PL16MT-16TX	16x RJ45 (-40 ...+75 °C)	1286820000	2.370,00 €	1
IE-SW-PL16M-14TX-2SC	14 x RJ45, 2 x SC Multi-mode	1241120000	2.625,00 €	1
IE-SW-PL16MT-14TX-2SC	14 x RJ45, 2 x SC Multi-mode (-40 ...+75 °C)	1286830000	2.988,00 €	1
IE-SW-PL16M-14TX-2ST	14 x RJ45, 2 x ST Multi-mode	1241130000	2.625,00 €	1
IE-SW-PL16MT-14TX-2ST	14 x RJ45, 2 x ST Multi-mode (-40 ...+75 °C)	1286840000	2.988,00 €	1
EBR-MODULE RS232	Yedekleme modülü	1241430000	131,00 €	1
<b>Gigabit Managed - Yönetilebilir Ethernet Switchler</b>				
IE-SW-PL10M-3GT-7TX	3 x RJ45 10/100/1000BaseT(X) 7 x RJ45 10/100BaseT(X)	1241290000	1.842,00 €	1
IE-SW-PL10MT-3GT-7TX	3 x RJ45 10/100/1000BaseT(X) 7 x RJ45 10/100BaseT(X) (-40 ...+75 °C)	1286930000	2.097,00 €	1
IE-SW-PL10M-1GT-2GS-7TX	1 x RJ45 10/100/1000BaseT(X) 2 x Slots 1000BaseSFP, 7 x RJ45 10/100BaseT(X)	1241300000	1.842,00 €	1
IE-SW-PL10MT-1GT-2GS-7TX	1 x RJ45 10/100/1000BaseT(X) 2 x Slots 1000BaseSFP, 7 x RJ45 10/100BaseT(X) (-40 ...+75 °C)	1286940000	2.097,00 €	1
IE-SW-PL18M-2GC-16TX	16 x RJ45 10/100BaseT(X) 2 x combo-ports	1241320000	2.569,00 €	1
IE-SW-PL18MT-2GC-16TX	16 x RJ45 10/100BaseT(X) 2 x combo-ports (-40 ...+75 °C)	1286970000	2.925,00 €	1
IE-SW-PL18M-2GC14TX2SC	14 x RJ45 10/100BaseT(X) 2 x SC Multi-mode 100FX, 2 x combo-ports	1241330000	3.690,00 €	1
IE-SW-PL18MT-2GC14TX2SC	14 x RJ45 10/100BaseT(X) 2 x SC Multi-mode 100FX, 2 x combo-ports (-40 ...+75 °C)	1286990000	3.546,00 €	1
IE-SW-PL18M-2GC14TX2ST	14 x RJ45 10/100BaseT(X) 2 x ST Multi-mode, 2 x combo-ports	1241340000	3.690,00 €	1
IE-SW-PL18MT-2GC14TX2SCS	14 x RJ45 10/100BaseT(X) 2 x SC Single-mode, 2 x combo-ports (-40 ...+75 °C)	1287010000	3.872,00 €	1

Serinin devamı sayfa 96



IE-SW-VL05M-5TX



IE-SW-PL08M-8TX



IE-SW-PL16M-16TX



IE-SW-PL10M-3GT-7TX



IE-SW-PL10M-1GT-2GS-7TX



IE-SW-PL18M-2GC14TX2SCS



IE-SW-PL18MT-2GC14TX2ST



IE-SFP-1GSXLC



IE-GW-MB-2TX-1RS232/485



IOT-GW30



IE-SR-4TX-LTE/4G-EU



IE-ANT-3G-806-2170-2-NF

Tip	Açıklama	Sipariş No	Fiyat/Birim	Ambalaj
IE-SW-PL18M-2GC14TX2SCS	14 x RJ45 10/100BaseT(X) 2 x SC Single-mode, 2 x combo-ports	1241350000	3.970,00 €	1
IE-SW-PL18MT-2GC14TX2ST	14 x RJ45 10/100BaseT(X) 2 x ST Multi-mode, 2 x combo-ports (-40 ...+75 °C)	1287000000	3.546,00 €	1

### Full Gigabit Managed - Yönetilebilir Ethernet Switchler

IE-SW-PL09M-5GC-4GT	4 x RJ45 10/100/1000BaseT(X) 5 x combo-ports	1241370000	3.330,00 €	1
IE-SW-PL09MT-5GC-4GT	4 x RJ45 10/100/1000BaseT(X) 5 x combo-ports (-40 ...+75 °C)	1287020000	2.733,00 €	1
IE-SFP-1GSXLC	Multi-mode LC konektör SFP Modülü 500m	1241490000	284,00 €	1
IE-SFP-1GLSXLC	Multi-mode LC konektör SFP Modülü 2 km	1241500000	462,00 €	1
IE-SFP-1GLXLC	Single-mode LC konektör SFP Modülü 10 km	1241510000	502,00 €	1
IE-SFP-1GLHXLC	Single-mode LC konektör SFP Modülü 40 km	1241520000	1.540,00 €	1
EBR-MODULE RS232	Yedekleme modülü	1241430000	131,00 €	1

### Seri / Ethernet Çevirici (COM/Server)

IE-CS-2TX-1RS232/485	2 x RJ45 ve 1 x RS232/422/485 Seri port girişi	1242080000	510,00 €	1
IE-CS-2TX-2RS232/485	2 x RJ45 ve 2 x RS232/422/485 Seri port girişi	1242090000	535,00 €	1

### Seri / Fiber Çevirici

IE-MCT-1RS232/485-1SC	1 x RS232/422/485, 1 x SC multimode (-40 ...+75 °C)	1344760000	374,00 €	1
IE-MCT-1RS232/485-1ST	1 x RS232/422/485, 1 x ST multimode (-40 ...+75 °C)	1362950000	374,00 €	1

**Not:** Seri Port Üzerinden Haberleşen Cihazlar ile Ethernet Network Topolojileri Üzerinden Haberleşme / Watdog timer ve Buzzer / Seri Port Ethernet ara yüzünde yüksek akımlara karşı 1kV izolasyon

### Modbus TCP/Modbus Serial Gateway

IE-GW-MB-2TX-1RS232/485	2x RJ45, 1x DB9 (RS-232), 1x terminal (RS-422/485), IP 30, 0 °C...+55 °C	1504460000	577,00 €	1
IE-GWT-MB-2TX-1RS232/485	2x RJ45, 1x DB9 (RS-232), 1x terminal (RS-422/485), IP 30, -40 °C...+75 °C	1504470000	836,00 €	1

### IOT Gateway

* IOT-GW30	IoT Gateway, Fast Ethernet, IP20, -20 °C...60 °C	2682620000	982,00 €	1
------------	--	------------	----------	---

### Endüstriyel Router

* IE-SR-4TX	Security/NAT/VPN/U-link Router, Fast Ethernet, 4 x RJ45 10/100BaseT(X)	2751270000	1.100,00 €	1
* IE-SR-4TX-LTE/4G-EU	Security/NAT/VPN/U-link Router, LTE / 4G modem, Fast Ethernet, 4 x RJ45 10/100BaseT(X)	2751280000	1.800,00 €	1
IE-SR-2GT-LTE/4G-EU	Security/NAT/VPN/U-link Router, LTE / 4G modem, Gigabit Ethernet, 2x 10/100/1000BaseT(X)	2535930000	2.000,00 €	1
IE-SR-6GT-LTE/4G-EU	Security/NAT/VPN/U-link Router, LTE / 4G modem, Gigabit Ethernet, 6x 10/100/1000BaseT(X)	2535960000	2.093,00 €	1
IE-SR-6GT-LAN	Security/NAT/VPN/U-link Router, Gigabit Ethernet, 6x 10/100/1000BaseT(X)	2535940000	1.900,00 €	1
IE-SR-2GT-LAN	LAN / WAN VPN router, 2 x Gigabit Ethernet	1345270000	1.580,00 €	1
IE-SR-2GT-LAN-FN	LAN / WAN router, 2 x Gigabit Ethernet	1489940000	1.279,00 €	1

**Not:** Yüksek Güvenlikli Firewall, 2 adet Gigabit Port (LAN / WAN), NAT maskeleyme 1:1 ağ haritalama ve port yönlendirme, VPN fonksiyonu, Entegre 3G / UMTS modem

### Endüstriyel 3G Router Antenleri

IE-ANT-3G-806-2170-2-NF	25W IP 54 (- 40 to 85 °C)	1491160000	162,00 €	1
IE-ANT-O-AH-360-5-NF	100W IP 66 (- 40 to 70 °C)	1367120000	408,00 €	1
IE-CC-NM-SMAM-2M	2m Anten kablosu N-type (male) -> SMA (male)	1491180000	51,00 €	1
IE-CC-NM-SMAM-4M	4m Anten kablosu N-type (male) -> SMA (male)	1491190000	82,00 €	1
IE-CC-NM-SMAM-6M	6m Anten kablosu N-type (male) -> SMA (male)	1491210000	97,00 €	1

### Wireless-Access Point/Bridge/Client

IE-WL-BL-AP-CL-EU	Wireless Access Point/Client, IEEE 802.11 a/b/g/n, 0 °C...60 °C	2536600000	850,00 €	1
IE-WLT-BL-AP-CL-EU	Wireless Access Point/Client, IEEE 802.11 a/b/g/n, -40 °C...75 °C	2536650000	1.000,00 €	1

Serinin devamı sayfa 97



IE-ANT-O-ABG-360-7-NF



IE-SW-IP67-5M12



IE-C6FP8LD0010M40M40-D



IE-C6FP8LD0005X40X40-Y



IE-C5ES8UG0010B41B41-E

Tip	Açıklama	Sipariş No	Fiyat/Birim	Ambalaj
IE-WL-VL-AP-BR-CL-EU	Wireless Access Point/Bridge/Client, IEEE 802.11 a/b/g/n, -25 °C...60 °C	2536680000	1.100,00 €	1
IE-WLT-VL-AP-BR-CL-EU	Wireless Access Point/Bridge/Client, IEEE 802.11 a/b/g/n, -40 °C...75 °C	2536690000	1.200,00 €	1

**Not:** IE 802.11 a/b/g uyumlu, Bilgi Transfer Hızı 54Mbit/s (2,4 ve 5 GHz band hızlarını desteklemektedir) / Turbo ring Roaming (50ms) ile kusursuz kablosuz bağlantı / Multi-SSID, VLAN,STP,RSTP desteği / WEP,WPA/WPA2 ve WPA2 kriptolama ile yüksek data güvenliği / POE ile uyumlu / e-mail ve röle çıkışları ile alarm oluşturma.

#### Kablosuz (WLAN) Uygulamalar İçin Antenler (Wireless Access Point için)

IE-ANT-O-ABG-360-7-NF	Omdirectional 2,4 ve 5GHz, IP 68	1367130000	318,00 €	1
IE-ANT-O-AH-360-5-NF	100W IP 66 (- 40 to 70 °C)	1367120000	408,00 €	1
IE-ANT-O-BG-360-6-NF	Omdirectional 2,4 IP 67	1367090000	479,00 €	1
IE-ANT-P-ABG-75-9-NF	Directional 2,4 ve 5GHz, IP 67	1367140000	281,00 €	1
IE-CC-NM-RPSMAM-4M	Anten kablosu N-Tip Erkek /RPSMA 4 metre	1367100000	135,00 €	1
IE-CC-NM-RPSMAM-2M	Anten kablosu N-Tip Erkek /RPSMA 2 metre	1367110000	125,00 €	1

#### Media Converter

IE-MC-VL-1TX-1SC	1 x RJ45, 1 x SC Multimode	1241400000	448,00 €	1
IE-MC-VL-1TX-1ST	1 x RJ45, 1 x ST Multimode	1241410000	500,00 €	1
IE-MC-VL-1TX-1SCS	1 x RJ45, 1 x SC Singlemode	1241420000	699,00 €	1

#### Switch IP 67

IE-SW-IP67-5M12	5 x M12 Konnektör girişi, IP 67 (-25 ...+60 °C)	1504410000	455,00 €	1
IE-SW-IP67T-5M12	5 x M12 Konnektör girişi, IP 67 (-40 ...+75 °C)	1504420000	527,00 €	1

#### Endüstriyel Ethernet Kabloları - Patch Kablo

##### Cat. 6 Patch kablo

IE-C6FP8LD0010M40M40-D	RJ45 IP20 CAT.6A / Class EA, LSZH 1m	1165940010	9,00 €	1
IE-C6FP8LD0020M40M40-D	RJ45 IP20 CAT.6A / Class EA, LSZH 2m	1165940020	13,00 €	1
IE-C6FP8LD0030M40M40-D	RJ45 IP20 CAT.6A / Class EA, LSZH 3m	1165940030	15,00 €	1
IE-C6FP8LD0040M40M40-D	RJ45 IP20 CAT.6A / Class EA, LSZH 4m	1165940040	18,00 €	1
IE-C6FP8LD0050M40M40-D	RJ45 IP20 CAT.6A / Class EA, LSZH 5m	1165940050	22,00 €	1
IE-C6FP8LD0200M40M40-D	RJ45 IP20 CAT.6A / Class EA, LSZH 20m	1165940200	70,00 €	1

##### Cat. 6 Crossover Patch kablo

IE-C6FP8LD0005X40X40-Y	RJ45 IP20 CAT.6A / Class EA, LSZH 0.5m	1312160005	8,00 €	1
IE-C6FP8LD0010X40X40-Y	RJ45 IP20 CAT.6A / Class EA, LSZH 1m	1312160010	9,50 €	1
IE-C6FP8LD0020X40X40-Y	RJ45 IP20 CAT.6A / Class EA, LSZH 2m	1312160020	12,00 €	1
IE-C6FP8LD0030X40X40-Y	RJ45 IP20 CAT.6A / Class EA, LSZH 3m	1312160030	15,00 €	1
IE-C6FP8LD0050X40X40-Y	RJ45 IP20 CAT.6A / Class EA, LSZH 5m	1312160050	22,00 €	1
IE-C6FP8LD0100X40X40-Y	RJ45 IP20 CAT.6A / Class EA, LSZH 10m	1312160100	38,00 €	1

#### Endüstriyel Ethernet Kabloları - IP 67 - 4 x 2 x AWG 26/7

IE-C5ES8UG0010B41B41-E	RJ45 IP67, V01 metal 1m	1066850000	100,00 €	1
IE-C5ES8UG0020B41B41-E	RJ45 IP67, V01 metal 2m	1066860000	87,70 €	1
IE-C5ES8UG0050B41B41-E	RJ45 IP67, V01 metal 5m	1066870000	125,00 €	1
IE-C5ES8UG0100B41B41-E	RJ45 IP67, V01 metal 10m	1066880000	134,00 €	1

#### Endüstriyel Ethernet Kabloları - M12 / X

##### M12 / M12 - 4 x 2 x AWG 22/7

IE-C5DD4UG0005MCSMCS-E	-40...70 °C - 0.5 m	1025950005	59,10 €	1
IE-C5DD4UG0015MCSMCS-E	-40...70 °C - 1.5 m	1025950015	80,00 €	1
IE-C5DD4UG0030MCSMCS-E	-40...70 °C - 3 m	1025950030	75,05 €	1
IE-C5DD4UG0050MCSMCS-E	-40...70 °C - 5 m	1025950050	90,00 €	1
IE-C5DD4UG0100MCSMCS-E	-40...70 °C - 10 m	1025950100	106,00 €	1
IE-C5DD4UG0015MSSMCS-E	-40...70 °C - 1.5 m	1059330015	80,00 €	1
IE-C5DD4UG0030MSSMCS-E	-40...70 °C - 3 m	1059330030	75,05 €	1
IE-C5DD4UG0050MSSMCS-E	-40...70 °C - 5 m	1059330050	87,80 €	1
IE-C5DD4UG0100MSSMCS-E	-40...70 °C - 10 m	1059330100	120,00 €	1



IE-C5DD4UG0015MCSXXX-X



IE-CT



PUNCH DOWN TOOL PDT



VDATE CAT6



IE-FCM-RJ45-C



IE-PS-RJ45-FH-BK



IE-T0-RJ45-C

Tip	Açıklama	Sipariş No	Fiyat/Birim	Ambalaj
<b>M12 / RJ45</b>				
IE-C5DD4UG0010MCSA20-E	-40...70 °C - 1 m	1044470010	69,40 €	1
IE-C5DD4UG0015MCSA20-E	-40...70 °C - 1.5 m	1044470015	90,00 €	1
IE-C5DD4UG0030MCSA20-E	-40...70 °C - 3 m	1044470030	100,00 €	1
IE-C5DD4UG0050MCSA20-E	-40...70 °C - 5 m	1044470050	94,95 €	1
IE-C5DD4UG0100MCSA20-E	-40...70 °C - 10 m	1044470100	127,00 €	1

Tip	Açıklama	Sipariş No	Fiyat/Birim	Ambalaj
<b>M12 / Boş</b>				
IE-C5DD4UG0015MCSXXX-X	-40...70 °C - 1.5 m	1025940015	37,55 €	1
IE-C5DD4UG0030MCSXXX-X	-40...70 °C - 3 m	1025940030	47,10 €	1
IE-C5DD4UG0050MCSXXX-X	-40...70 °C - 5 m	1025940050	70,00 €	1
IE-C5DD4UG0100MCSXXX-X	-40...70 °C - 10 m	1025940100	110,00 €	1

Tip	Açıklama	Sipariş No	Fiyat/Birim	Ambalaj
<b>Ethernet Kablo Test Cihazı</b>				
IE-CT	Ethernet Kablosu Test Cihazı	8808420000	5.040,00 TL	1
LAN USB TESTER	LAN ve USB bağlantıları için network kablo test aleti, LED skala/RJ45, USB A, USB B bağlantı tipi/max 1000 mt	9205400000	1.415,00 TL	1

Tip	Açıklama	Sipariş No	Fiyat/Birim	Ambalaj
<b>Ethernet Konnektörleri için El Aletleri</b>				
PUNCH DOWN TOOL PDT	Pach Panel Çakma	9013970000	673,00 TL	1
TT 8 RS MP 8	Sıkma	9202800000	7.176,00 TL	1
AM 12	0.5...12.5mm çap aralığına sahip UTP ve STP data kabloları için	9030060000	627,00 TL	1

Tip	Açıklama	Sipariş No	Fiyat/Birim	Ambalaj
<b>Data Hatları için OVP Modülü (Parafudr)</b>				
VDATE CAT6	Data hatları için aşırı gerilim koruma modülü	1348590000	141,00 €	1

Tip	Açıklama	Sipariş No	Fiyat/Birim	Ambalaj
<b>Basic Line Switchler için Kablo Tutucu</b>				
IE-CFK-05	Basic Line 5 Port Switchler için Kablo Tutucu	1339610000	51,00 €	1

Tip	Açıklama	Sipariş No	Fiyat/Birim	Ambalaj
<b>IE-FrontCom (IP65)</b>				
IE-FCM-RJ45-C	RJ45 Coupling (Cat.6A / Class EA)	1018790000	25,00 €	1
IE-FCM-USB-A	USB Coupling Type A	1018840000	21,00 €	1
IE-FCM-USB-AB	USB Coupling Type AB	1222550000	29,00 €	1

Tip	Açıklama	Sipariş No	Fiyat/Birim	Ambalaj
<b>RJ45 Fiş (IP20) - El Aleti Gerektirmeyen Montaj</b>				
IE-PS-RJ45-FH-BK	RJ45 Fiş, Cat6a / Class EA, Profinet, TIA - 568 A/B	1963600000	20,00 €	10
IE-PS-RJ45-FH-BK-A	RJ45 Fiş, Cat6a / Class EA, TIA - 568 A	1132040000	19,70 €	10
IE-PS-RJ45-FH-BK-B	RJ45 Fiş, Cat6a / Class EA, TIA - 568 B	1132050000	27,00 €	10
IE-PS-RJ45-FH-BK-P	RJ45 Fiş, Cat6a / Class EA, Profinet	1132060000	22,40 €	10
IE-BI-RJ45-FJ-P	RJ45 Soket, Profinet	1963830000	22,00 €	1

Tip	Açıklama	Sipariş No	Fiyat/Birim	Ambalaj
<b>Raya Montaj RJ45 Klemens</b>				
IE-T0-RJ45-C	RJ45 Fiş, Cat6a / Class EA, Profinet	8946920000	38,00 €	1
IE-T0-SCRJ-SM	Fiberoptik Coupling, Profinet	8947000000	40,15 €	1
IE-T0-USB	USB Coupling	8946960000	25,90 €	1

Tip	Açıklama	Sipariş No	Fiyat/Birim	Ambalaj
<b>M12 Ethernet Konnektör / Fiş</b>				
SAISM-4/8S-M12 4P D-ZF	M12 Düz,Erkek 4 Kutuplu (IP67)	1892120001	32,20 €	1
SAISW-4/8S-M12 4P D-ZF	M12 Açılı,Erkek 4 Kutuplu,Yaylı Bağlantı (IP67)	1803930001	34,15 €	1
SAISM-4/8S-M12-4P D-COD	M12 Düz,Erkek 4 Kutuplu (IP67)	1892120000	22,00 €	1

Tip	Açıklama	Sipariş No	Fiyat/Birim	Ambalaj
<b>M12 Ethernet Konnektör / Soket</b>				
SAIBM-4/8S-M12 4P D-ZF	M12 Düz,Dişi 4 Kutuplu,Yaylı Bağlantı (IP67)	1892130001	42,00 €	1
SAIBM-4/8S-M12-4P D-COD	M12 Düz,Dişi 4 Kutuplu (IP67)	1892130000	19,00 €	1

## Term Serisi Röleler

Geliştirilmiş mekanik ve elektronik fonksiyonları ile ray üzerinde simetrik ve her katı köprülenebilir şekilde kullanabileceğiniz Term serisi röleler panolarınızın güvenlik ve kalitesini bir üst sınıfa taşımaktadır. Ayırıcı mekanizma aynı zamanda geniş ve görsel algılamayı kolaylaştıracak şekilde LED gösterge olarak tasarlanmış olup kontak bilgisini rahatça okumanızı sağlar. Aynı taban üzerinde hem mekanik hem de optokuplör röle kullanımı mümkündür.

- Tek veya çift kontak yapısı
- Simetrik tasarım ve yuvarlatılmış keskin köşeler
- Geniş LED gösterge
- Universal giriş gerilimi (24...230 V AC/ DC)
- Anlaşılır markalama
- Her katı tarak köprü ile köprülenebilir yapı
- Montaj kolaylığı için ray üzerinde yüksek duruş

## Rider Serisi

Weidmüller'in yüksek performans gerektiren uygulamalar için push-in bağlantı teknolojisi ile donattığı bu yeni RCI serisi vidalı bağlantıya göre %75 zaman tasarrufu sağlar. Ayrıca vida bağlantılı olarak da temin edilebilir.

- Sağlam : Endüstriyel tip kalın pinler
- Güvenli : Diyot korumalı LED
- Pratik : Mekanik kontakların testi için test butonu
- Hızlı : Push-In soketler
- Kolay : ZQV vidasız üst köprüler
- Komple veya ayrı ayrı sipariş edilebilme imkanı





RCL314024



SRC 2CO



RCI314024



SRC-I 2CO

Tip	Giriş	Çıkış	Sipariş No	Fiyat/Birim	Ambalaj
<b>RCL Tip Röleler</b>					
<b>1 Kutuplu Enversör Kontak 16 A, 250V</b>					
RCL314024	24 VDC / 16,7 mA	250 V / 16 A, 1CO	8693260000	29,10 TL	20
RCL314524	24 VAC / 31,6 mA	250 V / 16 A, 1CO	8693500000	33,40 TL	20
RCL314615	115 VAC / 6,6 mA	250 V / 16 A, 1CO	8693890000	62,20 TL	20
RCL314730	230 VAC / 3,2 mA	250 V / 16 A, 1CO	8693320000	66,25 TL	20
<b>2 Kutuplu Enversör Kontak 2x8 A, 250 V</b>					
RCL424024	24 VDC / 16,7 mA DC	250 V / 2x8 A, 2CO	4058570000	29,95 TL	20
RCL424524	24 VAC / 31,6 mA AC	250 V / 2x8 A, 2CO	4058600000	38,55 TL	20
RCL424615	115 VAC / 6,6 mA AC	250 V / 2x8 A, 2CO	4058610000	61,60 TL	20
RCL424730	230 VAC / 3,2 mA AC	250 V / 2x8 A, 2CO	4058630000	59,60 TL	20
<b>RCL Röle Soketleri</b>					
SRC 2CO	RCL Vida Bağlantılı Röle Soketi		8690830000	44,80 TL	10
SRC CLIP LP	Plastik Klips		8691090000	4,77 TL	10
<b>RCL Röle LED ve Diyot Modülleri</b>					
RIM 2 6/24VDC	Diyotlu LED Modülü		8690950000	27,35 TL	10
RIM 3 6/24VUC	LED Modülü		8691010000	32,50 TL	10
RIM 3 110/230VUC	LED Modülü		8691030000	32,50 TL	10
RIM 4 110/230VUC	Varistörlü LED Modülü		8691060000	46,35 TL	10
<b>Not: RCL tipi röle gruplarında; röle, soket, LED ve koruma aksesuarları ayrı ayrı mevcuttur.</b>					
<b>RCI Tip Röleler</b>					
<b>1 Kutuplu Enversör Kontak 16 A, 250V</b>					
RCI314024	24 VDC / 16,7 mA	250 V / 16 A, 1CO	8869810000	45,55 TL	10
RCI314AC4	24 VDC / 16,7 mA, LED+Diyod	250 V / 16 A, 1CO	8870100000	61,65 TL	10
RCI314524	24 VAC / 31,6 mA	250 V / 16 A, 1CO	8869840000	56,00 TL	10
RCI314R24	24 VAC / 31,6 mA, LED	250 V / 16 A, 1CO	8870130000	75,15 TL	10
RCI314615	115 VAC / 6,6 mA	250 V / 16 A, 1CO	8869850000	62,20 TL	10
RCI314S15	115 VAC / 6,6 mA, LED	250 V / 16 A, 1CO	8870140000	85,80 TL	10
RCI314730	230 VAC / 3,2 mA	250 V / 16 A, 1CO	8869860000	62,60 TL	10
RCI314T30	230 VAC / 3,2 mA, LED	250 V / 16 A, 1CO	8870150000	129,35 TL	10
<b>2 Kutuplu Enversör Kontak 2x8 A, 250 V</b>					
RCI424024	24 VDC / 16,7 mA	250 V / 2x8 A, 2CO	8869890000	38,30 TL	10
RCI424AC4	24 VDC / 16,7 mA, LED+Diyod	250 V / 2x8 A, 2CO	8870180000	57,50 TL	10
RCI424524	24 VAC / 31,6 mA	250 V / 2x8 A, 2CO	8869920000	43,40 TL	10
RCI424R24	24 VAC / 31,6 mA, LED	250 V / 2x8 A, 2CO	8870210000	57,50 TL	10
RCI424615	115 VAC / 6,6 mA	250 V / 2x8 A, 2CO	8869930000	83,80 TL	10
RCI424S15	115 VAC / 6,6 mA, LED	250 V / 2x8 A, 2CO	8870220000	109,10 TL	10
RCI424730	230 VAC / 3,2 mA	250 V / 2x8 A, 2CO	8869940000	85,40 TL	10
RCI484T30	230 VAC / 3,2 mA, LED+Test Butonu	250 V / 2x8 A, 2CO	8870370000	102,75 TL	10
<b>Not: RCI Röleler Endüstriyel uygulamalar için kalın pinli olarak tasarlanmıştır. Opsiyonel olarak test soketli ve LED'li olarak seçilebilir.</b>					
<b>RCI Röle Soketleri</b>					
SRC-I 2CO	RCI Vida Bağlantılı Röle Soketi		8869490000	44,80 TL	10
SRC-I 2CO P	RCI Push In Bağlantılı Röle Soketi		8869500000	65,45 TL	10
SRC-I CLIP HP	Klips		8869510000	4,30 TL	10
<b>RCI LED ve Diyot Modülleri</b>					
RIM-I 2 6/24VDC	Diyotlu LED Modülü		8869590000	35,75 TL	10
RIM-I 3 6/24VUC	LED Modülü		8869630000	55,70 TL	10
RIM-I 3 110/230VUC	LED Modülü		8869650000	58,75 TL	10
SRC-I QV P	Üst Köprü		8870840000	18,35 TL	10
<b>Not: RCI tip röleler ile ayrıca Push In bağlantılı soketler kullanılabilir. Klips, LED ve koruma aksesuarları opsiyoneldir. Yanyana kullanılan röleler SRC-I QV ile köprülenebilir.</b>					



RCM270024



RCM570110



SCM 4CO



SCM-I 4CO N

Tip	Giriş	Çıkış	Sipariş No	Fiyat/Birim	Ambalaj
<b>RCM Tipi Minyatür Endüstriyel Röleler</b>					
<b>2 Kutuplu Enversör Kontak 2x12 A, 250 V</b>					
RCM270024	24 VDC / 31,3 mA	250 V / 2x12 A, 2CO	8689860000	67,20 TL	10
RCM270AC4	24 VDC / 31,3 mA, LED+Diyot	250 V / 2x12 A, 2CO	8957030000	87,70 TL	10
RCM270524	24 VAC / 41,6 mA	250 V / 2x12 A, 2CO	8689760000	71,50 TL	10
RCM270R24	24 VAC / 41,6 mA, LED	250 V / 2x12 A, 2CO	8689770000	154,45 TL	10
RCM270615	115 VAC / 8,8 mA	250 V / 2x12 A, 2CO	8689800000	132,55 TL	10
RCM270S15	115 VAC / 8,8 mA, LED	250 V / 2x12 A, 2CO	8689810000	102,40 TL	10
RCM270730	230 VAC / 4,3 mA	250 V / 2x12 A, 2CO	8689820000	73,90 TL	10
RCM270T30	230 VAC / 4,3 mA, LED	250 V / 2x12 A, 2CO	8689830000	128,25 TL	10
<b>3 Kutuplu Enversör Kontak 3x10 A, 250 V</b>					
RCM370024	24 VDC / 31,3 mA	250 V / 3x10 A, 3CO	8690040000	71,50 TL	10
RCM370AC4	24 VDC / 31,3 mA, LED+Diyot	250 V / 3x10 A, 3CO	8957100000	92,60 TL	10
RCM370524	24 VAC / 41,6 mA	250 V / 3x10 A, 3CO	8690030000	71,50 TL	10
RCM370R24	24 VAC / 41,6 mA, LED	250 V / 3x10 A, 3CO	8689950000	158,55 TL	10
RCM370615	115 VAC / 8,8 mA	250 V / 3x10 A, 3CO	8689980000	156,80 TL	10
RCM370S15	115 VAC / 8,8 mA, LED	250 V / 3x10 A, 3CO	8689990000	173,95 TL	10
RCM370730	230 VAC / 4,3 mA	250 V / 3x10 A, 3CO	8690000000	75,05 TL	10
RCM370T30	230 VAC / 4,3 Ma, LED	250 V / 3x10 A, 3CO	8690010000	209,25 TL	10
<b>4 Kutuplu Enversör Kontak 4x6 A, 250 V</b>					
RCM570024	24 VDC / 31,3 mA	250 V / 4x6 A, 4CO	8690200000	71,50 TL	10
RCM570AC4	24 VDC / 31,3 mA, LED+Diyot	250 V / 4x6 A, 4CO	8957170000	92,60 TL	10
RCM570524	24 VAC / 41,6 mA	250 V / 4x6 A, 4CO	8690110000	79,75 TL	10
RCM570R24	24 VAC / 41,6 mA, LED	250 V / 4x6 A, 4CO	8690120000	106,40 TL	10
RCM570110	110 VDC / 6,8 mA	250 V / 4x6 A, 4CO	8074700000	86,15 TL	10
RCM570615	115 VAC / 8,8 mA	250 V / 4x6 A, 4CO	1180800000	92,60 TL	10
RCM570S15	115 VAC / 8,8 mA, LED	250 V / 4x6 A, 4CO	8690150000	178,00 TL	10
RCM570730	230 VAC / 4,3 mA	250 V / 4x6 A, 4CO	1181100000	72,80 TL	10
RCM570T30	230 VAC / 4,3 mA, LED	250 V / 4x6 A, 4CO	8690160000	91,85 TL	10
<b>RCM Röle Soket ve Klipsleri</b>					
SCM 2CO	2 Kutuplu Vida Bağlantılı Röle Soketi		8690880000	47,05 TL	10
SCM 3CO	3 Kutuplu Vida Bağlantılı Röle Soketi		8690890000	45,90 TL	10
SCM 4CO	4 Kutuplu Vida Bağlantılı Röle Soketi		8690900000	52,65 TL	10
SCM CLIP P	Plastik Klips (Vidalı bağlantı için)		8691110000	5,04 TL	10
SCM-I 2CO P	2 Kutuplu Push In Bağlantılı Röle Soketi		8876220000	105,65 TL	10
SCM-I 4CO P	4 Kutuplu Push In Bağlantılı Röle Soketi		8869430000	115,45 TL	10
SCM-I CLIP P	Plastik Klips (Push In için)		8869440000	4,98 TL	10
SCM-I 4CO N	4 Kutuplu Vida Bağlantılı Röle Soketi		8869390000	50,40 TL	10
<b>RCM Röle LED ve Diyet Modülleri</b>					
RIM 2 6/24VDC	Diyotlu LED Modülü		8690950000	27,35 TL	10
RIM 3 6/24VUC	LED Modülü		8691010000	32,50 TL	10
RIM 3 110/230VUC	LED Modülü		8691030000	32,50 TL	10
RIM 4 6/24VUC	Varistörlü LED Modülü (Vidalı bağlantı için)		8691040000	55,70 TL	10
RIM 4 110/230VUC	Varistörlü LED Modülü		8691060000	46,35 TL	10
RIM-I 2 6/24VDC	Diyotlu LED Modülü		8869590000	35,75 TL	10
RIM-I 3 6/24VUC	LED Modülü		8869630000	55,70 TL	10
RIM-I 3 110/230VUC	LED Modülü		8869650000	58,75 TL	10
SCM-I QV P	2 Kutuplu Üst Köprü (Push In için)	10A / 240VAC	8870850000	19,50 TL	10
<b>Not:</b> RCM tipi minyatür röleler için vidalı ve Push In soketler, ledler, koruma devreleri ve üst köprüler.					





RRD321012



SRDI 3CO



RCIKIT 24VDC 1CO LD



RCMKIT-I 24VDC 3CO LD



DRI314012

Tip	Giriş	Çıkış	Sipariş No	Fiyat/Birim	Ambalaj
<b>RRD Serisi Güç Röleleri</b>					
RRD321012	12VDC / 109.1mA	10A / 240VAC	8799030000	166,05 TL	25
RRD321024	24VDC / 50.5mA	10A / 240VAC	8690610000	140,85 TL	25
RRD321048	48VDC / 24mA	10A / 240VAC	8690630000	172,55 TL	25
RRD321110	110VDC / 11mA	10A / 240VAC	8690650000	154,55 TL	25
RRD321220	220VDC / 5,5mA	10A / 240VAC	7940007742	252,90 TL	25
RRD326230	230 VAC / 5,1mA	10A / 240VAC	8690570000	209,25 TL	25
SRDI 3CO	3 Kontak RRD Röle soketi (11 Pin)		8869350000	55,80 TL	25

**Not:** 2 kontak röleler için bizimle iletişime geçebilirsiniz.

#### Endüstriyel Tip Röle Kitleri

##### RCI TİP RÖLELER, 1 Kutuplu Enversör Kontak 16 A, 250 V

RCIKIT 24VDC 1CO LD	24 VDC / 16,7 mA, LED+Diyod	250 V / 16 A, 1CO	8871000000	138,15 TL	10
RCIKIT 24VAC 1CO LD	24 VAC / 31,6 mA, LED	250 V / 16 A, 1CO	8871010000	157,20 TL	10
RCIKIT 115VAC 1CO LD	115 VAC / 6,6 mA, LED	250 V / 16 A, 1CO	8897090000	171,55 TL	10
RCIKIT 230VAC 1CO LD	230 VAC / 3,2 mA, LED	250 V / 16 A, 1CO	8871020000	209,25 TL	10

##### RCI TİP RÖLELER, 2 Kutuplu Enversör Kontak 2x8 A, 250 V

RCIKIT 24VDC 2CO LD	24 VDC / 16,7 mA, LED+Diyod	250 V / 2x8 A, 2CO	8871030000	142,25 TL	10
RCIKIT 24VAC 2CO LD	24 VAC / 31,6 mA, LED	250 V / 2x8 A, 2CO	8871040000	186,70 TL	10
RCIKIT 115VAC 2CO LD	115 VAC / 6,6 mA, LED	250 V / 2x8 A, 2CO	8897100000	180,45 TL	10
RCIKIT 230VAC 2CO LD	230 VAC / 3,2 mA, LED	250 V / 2x8 A, 2CO	8871050000	177,40 TL	10

##### RCM TİP MİNYATÜR ENDÜSTRİYEL RÖLELER, 2 Kutuplu Enversör Kontak 2x12 A, 250 V

RCMKIT-I 24VDC 2CO LD	24 VDC / 31,3 mA, LED	250 V / 2x12 A, 2CO	8920940000	228,50 TL	10
RCMKIT-I 24VAC 2CO LD	24 VAC / 41,6 mA, LED	250 V / 2x12 A, 2CO	8920950000	302,40 TL	10
RCMKIT-I 115VAC 2CO LD	115 VAC / 8,8 mA, LED	250 V / 2x12 A, 2CO	8920960000	280,50 TL	10
RCMKIT-I 230VAC 2CO LD	230 VAC / 4,3 mA, LED	250 V / 2x12 A, 2CO	8920970000	259,65 TL	10

##### RCM TİP MİNYATÜR ENDÜSTRİYEL RÖLELER, 3 Kutuplu Enversör Kontak 3x10 A, 250 V

RCMKIT-I 24VDC 3CO LD	24 VDC / 31,3 mA, LED	250 V / 3x10 A, 3CO	8920980000	299,60 TL	10
RCMKIT-I 24VAC 3CO LD	24 VAC / 41,6 mA, LED	250 V / 3x10 A, 3CO	8920990000	267,55 TL	10
RCMKIT-I 115VAC 3CO LD	115 VAC / 8,8 mA, LED	250 V / 3x10 A, 3CO	8921010000	173,80 TL	10
RCMKIT-I 230VAC 3CO LD	230 VAC / 4,3 mA, LED	250 V / 3x10 A, 3CO	8921020000	275,40 TL	10

##### RCM TİP MİNYATÜR ENDÜSTRİYEL RÖLELER, 4 Kutuplu Enversör Kontak 4x6 A, 250 V

RCMKIT-I 24VDC 4CO LD	24 VDC / 31,3 mA, LED	250 V / 4x6 A, 4CO	8921030000	241,90 TL	10
RCMKIT-I 24VAC 4CO LD	24 VAC / 41,6 mA, LED	250 V / 4x6 A, 4CO	8921040000	269,90 TL	10
RCMKIT-I 115VAC 4CO LD	115 VAC / 8,8 mA, LED	250 V / 4x6 A, 4CO	8921050000	255,90 TL	10
RCMKIT-I 230VAC 4CO LD	230 VAC / 4,3 mA, LED	250 V / 4x6 A, 4CO	8921060000	238,35 TL	10

#### DRI Serisi Röleler

##### 1CO Kontak, 10 A / 250 V AC

Röle	Giriş	Çıkış	Sipariş No	Fiyat/Birim	Ambalaj
DRI314012	12 VDC / 44,4 mA	250 V / 10 A, 1CO	7760056296	37,20 TL	20
DRI314024	24 VDC / 21,8 mA	250 V / 10 A, 1CO	7760056297	38,00 TL	20
DRI314048	48 VDC / 11,2 mA	250 V / 10 A, 1CO	7760056298	41,65 TL	20
DRI314110	110 VDC / 4,8 mA	250 V / 10 A, 1CO	7760056299	45,65 TL	20
DRI314524	24 VAC / 50 mA	250 V / 10 A, 1CO	7760056300	50,25 TL	20
DRI314615	115 VAC / 9,3 mA	250 V / 10 A, 1CO	7760056301	49,10 TL	20
DRI314730	230 VAC / 4,9 mA	250 V / 10 A, 1CO	7760056302	50,25 TL	20

##### Röle + LED

DRI314012L	12 VDC / 44,4 mA, LED	250 V / 10 A, 1CO	7760056303	43,35 TL	20
DRI314024L	24 VDC / 21,8 mA, LED	250 V / 10 A, 1CO	7760056304	44,35 TL	20
DRI314048L	48 VDC / 11,2 mA, LED	250 V / 10 A, 1CO	7760056305	48,05 TL	20
DRI314110L	110 VDC / 4,8 mA, LED	250 V / 10 A, 1CO	7760056306	51,20 TL	20

Serinin devamı sayfa 103



DRI314012LD



DRI314524LT



DRI314012LTD



DRI424012L



DRI424012LD



DRI424524LT



DRI424012LTD

Tip	Giriş	Çıkış	Sipariş No	Fiyat/Birim	Ambalaj
DRI314524L	24 VAC / 44,4 mA, LED	250 V / 10 A, 1CO	7760056307	56,00 TL	20
DRI314615L	115 VAC / 44,4 mA, LED	250 V / 10 A, 1CO	7760056308	54,75 TL	20
DRI314730L	230 VAC / 44,4 mA, LED	250 V / 10 A, 1CO	7760056309	56,00 TL	20
<b>Röle + LED + Diyot</b>					
DRI314012LD	12 VDC / 44,4 mA, LED + Diyot	250 V / 10 A, 1CO	7760056310	43,35 TL	20
DRI314024LD	24 VDC / 21,8 mA, LED + Diyot	250 V / 10 A, 1CO	7760056311	44,35 TL	20
DRI314048LD	48 VDC / 11,2 mA, LED + Diyot	250 V / 10 A, 1CO	7760056312	47,00 TL	20
DRI314110LD	110 VDC / 4,8 mA, LED + Diyot	250 V / 10 A, 1CO	7760056313	51,20 TL	20
<b>Röle + LED + Test Butonu</b>					
DRI314524LT	24 VAC / 50 mA, LED + Test	250 V / 10 A, 1CO	7760056318	62,35 TL	20
DRI314615LT	115 VAC / 9,3 mA, LED + Test	250 V / 10 A, 1CO	7760056319	60,95 TL	20
DRI314730LT	230 VAC / 4,9 mA, LED + Test	250 V / 10 A, 1CO	7760056320	64,00 TL	20
<b>Röle + LED + Diyot + Test Butonu</b>					
DRI314012LTD	12 VDC / 44,4 mA, LED + Diyot + Test	250 V / 10 A, 1CO	7760056314	49,10 TL	20
DRI314024LTD	24 VDC / 21,8 mA, LED + Diyot + Test	250 V / 10 A, 1CO	7760056315	50,25 TL	20
DRI314048LTD	48 VDC / 11,2 mA, LED + Diyot + Test	250 V / 10 A, 1CO	7760056316	52,55 TL	20
DRI314110LTD	110 VDC / 4,8 mA, LED + Diyot + Test	250 V / 10 A, 1CO	7760056317	57,45 TL	20
<b>2CO Kontak, 5 A / 250 V AC</b>					
<b>Röle</b>					
DRI424012	12 VDC / 44,4 mA	250 V / 2x5 A, 2CO	7760056321	40,70 TL	20
DRI424024	24 VDC / 21,8 mA	250 V / 2x5 A, 2CO	7760056322	41,65 TL	20
DRI424048	48 VDC / 11,2 mA	250 V / 2x5 A, 2CO	7760056323	43,35 TL	20
DRI424110	110 VDC / 4,8 mA	250 V / 2x5 A, 2CO	7760056324	47,65 TL	20
DRI424524	24 VAC / 50 mA	250 V / 2x5 A, 2CO	7760056325	52,35 TL	20
DRI424615	115 VAC / 9,3 mA	250 V / 2x5 A, 2CO	7760056326	51,20 TL	20
DRI424730	230 VAC / 4,9 mA	250 V / 2x5 A, 2CO	7760056327	53,75 TL	20
<b>Röle + LED</b>					
DRI424012L	12 VDC / 44,4 mA, LED	250 V / 2x5 A, 2CO	7760056328	49,10 TL	20
DRI424024L	24 VDC / 21,8 mA, LED	250 V / 2x5 A, 2CO	7760056329	50,25 TL	20
DRI424048L	48 VDC / 11,2 mA, LED	250 V / 2x5 A, 2CO	7760056330	52,55 TL	20
DRI424110L	110 VDC / 4,8 mA, LED	250 V / 2x5 A, 2CO	7760056331	57,45 TL	20
DRI424524L	24 VAC / 44,4 mA, LED	250 V / 2x5 A, 2CO	7760056332	60,95 TL	20
DRI424615L	115 VAC / 44,4 mA, LED	250 V / 2x5 A, 2CO	7760056333	60,95 TL	20
DRI424730L	230 VAC / 44,4 mA, LED	250 V / 2x5 A, 2CO	7760056334	64,00 TL	20
<b>Röle + LED + Diyot</b>					
DRI424012LD	12 VDC / 44,4 mA, LED + Diyot	250 V / 2x5 A, 2CO	7760056335	49,10 TL	20
DRI424024LD	24 VDC / 21,8 mA, LED + Diyot	250 V / 2x5 A, 2CO	7760056336	50,25 TL	20
DRI424048LD	48 VDC / 11,2 mA, LED + Diyot	250 V / 2x5 A, 2CO	7760056337	52,55 TL	20
DRI424110LD	110 VDC / 4,8 mA, LED + Diyot	250 V / 2x5 A, 2CO	7760056338	57,45 TL	20
<b>Röle + LED + Test Butonu</b>					
DRI424524LT	24 VAC / 50 mA, LED + Test	250 V / 2x5 A, 2CO	7760056343	68,05 TL	20
DRI424615LT	115 VAC / 9,3 mA, LED + Test	250 V / 2x5 A, 2CO	7760056344	69,85 TL	20
DRI424730LT	230 VAC / 4,9 mA, LED + Test	250 V / 2x5 A, 2CO	7760056345	69,85 TL	20
<b>Röle + LED + Diyot + Test Butonu</b>					
DRI424012LTD	12 VDC / 44,4 mA, LED + Diyot + Test	250 V / 2x5 A, 2CO	7760056339	54,75 TL	20
DRI424024LTD	24 VDC / 21,8 mA, LED + Diyot + Test	250 V / 2x5 A, 2CO	7760056340	56,00 TL	20
DRI424048LTD	48 VDC / 11,2 mA, LED + Diyot + Test	250 V / 2x5 A, 2CO	7760056341	58,15 TL	20
DRI424110LTD	110 VDC / 4,8 mA, LED + Diyot + Test	250 V / 2x5 A, 2CO	7760056342	63,20 TL	20



SDI 1CO



DRM270012



DRM570012

Tip	Giriş	Çıkış	Sipariş No	Fiyat/Birim	Ambalaj
<b>DRI Tip Röle Soket ve Klips</b>					
<b>Röle + LED + Diyot + Test Butonu</b>					
SDI 1CO	DRI Vida Bağlantılı 1CO Röle Soketi		7760056350	31,60 TL	10
SDI 2CO	DRI Vida Bağlantılı 2CO Röle Soketi		7760056351	33,90 TL	10
SDI CLIP	Plastik Klip		7760056352	3,62 TL	10
SDI 1CO P	Push-in bağlantılı 1CO Röle Soketi		7760056364	52,70 TL	20
SDI 2CO P	Push-in bağlantılı 2CO Röle Soketi		7760056365	56,90 TL	20
<b>DRM Serisi Röleler</b>					
<b>2 CO Kontakt, 10 A / 250 V AC</b>					
DRM270012	12VDC/75mA	10 A / 250 V AC, 2 CO	7760056050	44,35 TL	20
DRM270024	24VDC/36,8mA	10 A / 250 V AC, 2 CO	7760056051	44,35 TL	20
DRM270048	48VDC/18,5mA	10 A / 250 V AC, 2 CO	7760056052	45,25 TL	20
DRM270110	110VDC/10mA	10 A / 250 V AC, 2 CO	7760056053	50,00 TL	20
DRM270220	220VDC/5,2mA	10 A / 250 V AC, 2 CO	7760056054	64,70 TL	20
DRM270524	24VAC/62,4mA @50Hz	10 A / 250 V AC, 2 CO	7760056055	45,25 TL	20
DRM270548	48VAC/33,3mA @50Hz	10 A / 250 V AC, 2 CO	7760056056	45,25 TL	20
DRM270615	115VAC/12,6mA @50Hz	10 A / 250 V AC, 2 CO	7760056057	45,25 TL	20
DRM270730	230VAC/6,1mA @50Hz	10 A / 250 V AC, 2 CO	7760056058	50,00 TL	20
DRM270012L	12VDC +LED/75mA	10 A / 250 V AC, 2 CO	7760056059	47,45 TL	20
DRM270024L	24VDC+LED/36,8mA	10 A / 250 V AC, 2 CO	7760056060	47,45 TL	20
DRM270048L	48VDC+LED/18,5mA	10 A / 250 V AC, 2 CO	7760056061	48,40 TL	20
DRM270110L	110VDC+LED/10mA	10 A / 250 V AC, 2 CO	7760056062	53,75 TL	20
DRM270220L	220VDC+LED/5,2mA	10 A / 250 V AC, 2 CO	7760056063	65,25 TL	20
DRM270524L	24VAC+LED/62,4mA @50Hz	10 A / 250 V AC, 2 CO	7760056064	50,50 TL	20
DRM270548L	48VAC+LED/33,3mA @50Hz	10 A / 250 V AC, 2 CO	7760056065	49,40 TL	20
DRM270615L	115VAC+LED/12,6mA @50Hz	10 A / 250 V AC, 2 CO	7760056066	49,40 TL	20
DRM270730L	230VAC+LED/6,1mA @50Hz	10 A / 250 V AC, 2 CO	7760056067	52,35 TL	20
<b>4 CO Kontakt, 5 A / 250 V AC</b>					
DRM570012	12VDC/75mA	5 A / 250 V AC, 4 CO	7760056078	47,45 TL	20
DRM570024	24VDC/36,8mA	5 A / 250 V AC, 4 CO	7760056079	47,45 TL	20
DRM570048	48VDC/18,5mA	5 A / 250 V AC, 4 CO	7760056080	47,65 TL	20
DRM570110	110VDC/10mA	5 A / 250 V AC, 4 CO	7760056081	51,70 TL	20
DRM570220	220VDC/5,2mA	5 A / 250 V AC, 4 CO	7760056082	65,25 TL	20
DRM570524	24VAC/62,4mA @50Hz	5 A / 250 V AC, 4 CO	7760056083	48,70 TL	20
DRM570548	48VAC/33,3mA @50Hz	5 A / 250 V AC, 4 CO	7760056084	47,65 TL	20
DRM570615	115VAC/12,6mA @50Hz	5 A / 250 V AC, 4 CO	7760056085	48,70 TL	20
DRM570730	230VAC/6,1mA @50Hz	5 A / 250 V AC, 4 CO	7760056086	53,10 TL	20
DRM570012L	12VDC +LED/75mA	5 A / 250 V AC, 4 CO	7760056087	50,50 TL	20
DRM570024L	24VDC+LED/36,8mA	5 A / 250 V AC, 4 CO	7760056088	50,50 TL	20
DRM570048L	48VDC+LED/18,5mA	5 A / 250 V AC, 4 CO	7760056089	51,20 TL	20
DRM570110L	110VDC+LED/10mA	5 A / 250 V AC, 4 CO	7760056090	55,25 TL	20
DRM570220L	220VDC+LED/5,2mA	5 A / 250 V AC, 4 CO	7760056091	71,55 TL	20
DRM570524L	24VAC+LED/62,4mA @50Hz	5 A / 250 V AC, 4 CO	7760056092	53,00 TL	20
DRM570548L	48VAC+LED/33,3mA @50Hz	5 A / 250 V AC, 4 CO	7760056093	51,80 TL	20
DRM570615L	115VAC+LED/12,6mA @50Hz	5 A / 250 V AC, 4 CO	7760056094	54,40 TL	20
DRM570730L	230VAC+LED/6,1mA @50Hz	5 A / 250 V AC, 4 CO	7760056095	61,65 TL	20
<ul style="list-style-type: none"> <li>• Yüksek anahtarlama gücüne sahip kompakt yapı.</li> <li>• Geniş bobin giriş voltaj aralığı.</li> <li>• Opsiyonel test butonu (AC kırmızı, DC mavi).</li> <li>• Opsiyonel durum LEDi (AC kırmızı, DC yeşil).</li> <li>• Opsiyonel diyot koruması</li> </ul>					
<b>LED'li ve Test Butonlu 4 CO Kontakt, 5A / 250 VAC</b>					
DRM570012LT	12VDC/75mA	5 A / 250 V AC, 4 CO	7760056096	51,20 TL	20
DRM570024LT	24VDC/36,8mA	5 A / 250 V AC, 4 CO	7760056097	52,35 TL	20
DRM570524LT	24VAC/62,4mA @50Hz	5 A / 250 V AC, 4 CO	7760056101	55,55 TL	20

Serinin devamı sayfa 105



FS 2CO

Tip	Giriş	Çıkış	Sipariş No	Fiyat/Birim	Ambalaj
DRM570048LT	48VDC/18,5mA	5 A / 250 V AC, 4 CO	7760056098	55,15 TL	20
DRM570548LT	48VAC/33,3mA @50Hz	5 A / 250 V AC, 4 CO	7760056102	55,55 TL	20
DRM570110LT	110VDC/10mA	5 A / 250 V AC, 4 CO	7760056099	58,25 TL	20
DRM570615LT	115VAC/12,6mA @50Hz	5 A / 250 V AC, 4 CO	7760056103	57,00 TL	20
DRM570220LT	220VDC/5,2mA	5 A / 250 V AC, 4 CO	7760056100	73,90 TL	20
DRM570730LT	230VAC/6,1mA @50Hz	5 A / 250 V AC, 4 CO	7760056104	58,60 TL	20

**DRM Tip Röle Soket ve Klipsleri**

FS 2CO	2 kontak röle soketi	7760056106	26,90 TL	10
FS 4CO	4 kontak röle soketi	7760056107	33,90 TL	10
DRM/DRL CLIP M	Metal Klip	7760056108	1,37 TL	10
SCM 2CO P	2 kontak röle soketi Push-in	7760056362	86,95 TL	10
SCM 4CO P	4 kontak röle soketi Push-in	7760056363	98,80 TL	10

**DRM Tip Röle LED ve Koruma Modülleri**

RIM 1 6/230VDC	Diyot Koruması 6...230 V DC	7760056169	8,83 TL	10
RIM 3 110/230VAC	RC filtre koruması 110...230 V AC	7760056014	26,90 TL	10
RIM 3 110/230VAC LED	RC filtre koruması 110...230 V AC LED ile birlikte	7760056045	26,90 TL	10
RIM 2 6/24VDC	Yeşil LED 6...24 V DC diyot korumalı	7760056015	17,25 TL	10
RIM 2 24/60VDC	Yeşil LED 24...60 V DC diyot korumalı	7760056016	17,25 TL	10
RIM 2 110/230VDC	Yeşil LED 110...230 V DC diyot korumalı	7760056017	16,85 TL	10
RIM 3 6/24VUC	Yeşil LED 6...24 V DC / V AC	7940018457	17,25 TL	20
RIM 3 24/60VUC	Yeşil LED 24...60 V DC / V AC	7760056018	16,85 TL	10
RIM 3 110/230VUC	Yeşil LED 110...230 V DC / V AC	7940018455	17,70 TL	20

**DRL Güç Röleleri****1 CO Kontak, 16 A / 250 V AC**

DRL170012L	12VDC/75mA	16 A/250VAC, 1CO	1133450000	126,20 TL	20
DRL170024L	24VDC/36,8mA	16 A/250VAC, 1CO	1133460000	126,20 TL	20
DRL170048L	48VDC/18,5mA	16 A/250VAC, 1CO	1133470000	138,15 TL	20
DRL170110L	110VDC/10mA	16 A/250VAC, 1CO	1133480000	151,40 TL	20
DRL170220L	220VDC/5,2mA	16 A/250VAC, 1CO	1133490000	151,40 TL	20
DRL170524L	24VAC/54mA	16 A/250VAC, 1CO	1133840000	138,15 TL	20
DRL170615L	115VAC/12,9mA	16 A/250VAC, 1CO	1133850000	151,40 TL	20
DRL170730L	230VAC/6,8mA	16 A/250VAC, 1CO	1133860000	151,40 TL	20

**2 CO Kontak, 10 A / 250 V AC**

DRL270012L	12VDC/75mA	10 A/250VAC, 2CO	1133510000	151,40 TL	20
DRL270024L	24VDC/36,8mA	10 A/250VAC, 2CO	1133520000	151,40 TL	20
DRL270048L	48VDC/18,5mA	10 A/250VAC, 2CO	1133530000	164,10 TL	20
DRL270110L	110VDC/10mA	10 A/250VAC, 2CO	1133540000	176,75 TL	20
DRL270220L	220VDC/5,2mA	10 A/250VAC, 2CO	1133550000	176,00 TL	20
DRL270524L	24VAC/54mA	10 A/250VAC, 2CO	1133870000	164,10 TL	20
DRL270615L	115VAC/12,9mA	10 A/250VAC, 2CO	1133880000	176,00 TL	20
DRL270730L	230VAC/6,8mA	10 A/250VAC, 2CO	1133890000	176,00 TL	20

**3 CO Kontak, 10 A / 250 V AC**

DRL370012L	12VDC/120mA	10 A/250VAC, 3CO	1133570000	188,60 TL	10
DRL370024L	24VDC/60mA	10 A/250VAC, 3CO	1133580000	193,00 TL	10
DRL370048L	48VDC/30mA	10 A/250VAC, 3CO	1133590000	213,90 TL	10
DRL370110L	110VDC/13,1mA	10 A/250VAC, 3CO	1133600000	226,40 TL	10
DRL370220L	220VDC/6,7mA	10 A/250VAC, 3CO	1133610000	226,40 TL	10
DRL370524L	24VAC/80mA	10 A/250VAC, 3CO	1133910000	213,90 TL	10
DRL370615L	115VAC/16mA	10 A/250VAC, 3CO	1133920000	226,40 TL	10
DRL370730L	230VAC/10mA	10 A/250VAC, 3CO	1133930000	226,40 TL	10



DRL170012L



DRL370012L



DRL570012L



SLD F 2CO



RRR270012L



RRR370012L



SRD ECO 2CO



TRS 24VDC 1CO

Tip	Giriş	Çıkış	Sipariş No	Fiyat/Birim	Ambalaj
<b>4 CO Kontak, 10 A / 250 V AC</b>					
DRL570012L	12VDC/125mA	10 A/250VAC, 4CO	1133620000	251,05 TL	10
DRL570024L	24VDC/66,7mA	10 A/250VAC, 4CO	1133630000	251,05 TL	10
DRL570048L	48VDC/31,2mA	10 A/250VAC, 4CO	1133640000	276,85 TL	10
DRL570110L	110VDC/16,2mA	10 A/250VAC, 4CO	1133650000	301,60 TL	10
DRL570220L	220VDC/7,6mA	10 A/250VAC, 4CO	1133660000	301,60 TL	10
DRL570524L	24VAC/93,7mA	10 A/250VAC, 4CO	1133940000	276,85 TL	10
DRL570615L	115VAC/25,5mA	10 A/250VAC, 4CO	1133950000	301,60 TL	10
DRL570730L	230VAC/13,1mA	10 A/250VAC, 4CO	1133960000	301,60 TL	10
<b>DRL Tip Rölelerin Soket ve Klipsleri</b>					
SLD F 2CO	2 kontak vidalı tip röle soketi		7760056225	87,00 TL	10
SLD F 3CO	3 kontak vidalı tip röle soketi		7760056226	109,70 TL	10
SLD F 4CO	4 kontak vidalı tip röle soketi		7760056227	127,35 TL	10
DRM/DRL CLIP M	Metal Klips		7760056108	1,37 TL	10
SLD CLIP 3CO M	3 kontak soket Klips		7760056234	8,40 TL	10
SLD CLIP 4CO M	4 kontak soket Klips		7760056235	8,40 TL	10
<b>DRL Tip Röle Koruma Modülü</b>					
RIM 1 6/230VDC	Diyot Koruması 6...230 V DC		7760056169	8,83 TL	10
RIM 3 110/230VAC	RC filtre koruması 110...230 V AC		7760056014	26,90 TL	10
RIM 5 6/230VAC	4 kontak soket için RC filtre		1174670000	38,55 TL	10
RIM 5 6/230VDC	4 kontak soket için diyot		1174650000	39,35 TL	10
<b>DRR Güç Röleleri</b>					
<b>2 CO Kontak, 10 A / 250 V AC</b>					
DRR270012L	12VDC/125mA	10 A/250VAC, 2CO	1133360000	102,40 TL	10
DRR270024L	24VDC/55,8mA	10 A/250VAC, 2CO	1133370000	104,80 TL	10
DRR270048L	48VDC/29,3mA	10 A/250VAC, 2CO	1133380000	113,55 TL	10
DRR270110L	110VDC/14,9mA	10 A/250VAC, 2CO	1133390000	126,20 TL	10
DRR270220L	220VDC/7,5mA	10 A/250VAC, 2CO	1133400000	151,40 TL	10
DRR270524L	24VAC/130mA @50Hz	10 A/250VAC, 2CO	1133760000	101,00 TL	10
DRR270615L	115VAC/29,8mA @50Hz	10 A/250VAC, 2CO	1133780000	113,55 TL	10
DRR270730L	230VAC/14,9mA @50Hz	10 A/250VAC, 2CO	1133800000	113,55 TL	10
<b>3 CO Kontak, 10 A / 250 V AC</b>					
DRR370012L	12VDC/125mA	10 A/250VAC, 3CO	1133410000	116,20 TL	10
DRR370024L	24VDC/55,8mA	10 A/250VAC, 3CO	1133420000	116,20 TL	10
DRR370048L	48VDC/29,3mA	10 A/250VAC, 3CO	1133430000	126,20 TL	10
DRR370110L	110VDC/14,9mA	10 A/250VAC, 3CO	1133440000	145,10 TL	10
DRR370220L	220VDC/7,5mA	10 A/250VAC, 3CO	1133560000	164,10 TL	10
DRR370524L	24VAC/130mA @50Hz	10 A/250VAC, 3CO	1133810000	129,10 TL	10
DRR370615L	115VAC/29,8mA @50Hz	10 A/250VAC, 3CO	1133820000	145,10 TL	10
DRR370730L	230VAC/14,9mA @50Hz	10 A/250VAC, 3CO	1133830000	141,35 TL	10
<b>DRR Tip Rölelerin Soket ve Aksesuarları</b>					
SRD ECO 2CO	2 kontak röle soketi		1132810000	40,45 TL	10
SRD ECO 3CO	3 kontak röle sokeri		1132820000	40,45 TL	10
DRR CLIP M	Metal Klips		1134160000	6,32 TL	10
RIM 5 6/230VAC	4 kontak soket için RC filtre		1174670000	38,55 TL	10
RIM 5 6/230VDC	4 kontak soket için diyot		1174650000	39,35 TL	10
<b>Term Serisi Röleler</b>					
<b>1 CO Kontak 6A, 6,4 mm genişlik</b>					
TRS 24VDC 1CO	24 VDC	250V / 6A, 1CO	1122770000	95,95 TL	10
TRS 24VUC 1CO	24V AC/DC	250V / 6A, 1CO	1122780000	135,05 TL	10
TRS 120VUC 1CO	120V AC/DC	250V / 6A, 1CO	1122810000	189,90 TL	10

Serinin devamı sayfa 107



TRS 5VDC 1CO 16A



TRS 24VDC 1NO HC



TRS 24VDC 2CO

Tip	Giriş	Çıkış	Sipariş No	Fiyat/Birim	Ambalaj
TRS 230VUC 1CO	230V AC/DC	250V / 6A, 1CO	1122820000	189,90 TL	10
TRS 120VAC RC 1CO	120V AC	250V / 6A, 1CO	1122830000	226,40 TL	10
TRS 230VAC RC 1CO	230V AC	250V / 6A, 1CO	1122840000	237,70 TL	10
TRS 24-230VUC 1CO	24 V.....230 VAC/dc üniversal giriş	250V / 6A, 1CO	1122850000	308,20 TL	10
<b>1 CO Kontak 16A, 12,8 mm genişlik</b>					
TRS 5VDC 1CO 16A	5V DC	250V / 16A, 1CO	1479650000	169,60 TL	10
TRS 12VDC 1CO 16A	12V DC	250V / 16A, 1CO	1479670000	171,10 TL	10
TRS 24VDC 1CO 16A	24V DC	250V / 16A, 1CO	1479680000	175,90 TL	10
TRS 24VUC 1CO 16A	24V AC/DC	250V / 16A, 1CO	1479690000	194,90 TL	10
TRS 48VUC 1CO 16A	48V AC/DC	250V / 16A, 1CO	1479700000	199,35 TL	10
TRS 60VUC 1CO 16A	60V AC/DC	250V / 16A, 1CO	1479710000	198,30 TL	10
TRS 120VUC 1CO 16A	120V AC/DC	250V / 16A, 1CO	1479730000	206,75 TL	10
TRS 230VUC 1CO 16A	230V AC/DC	250V / 16A, 1CO	1479740000	206,75 TL	10
TRS 120VAC RC 1CO 16A	120V AC	250V / 16A, 1CO	1479750000	253,80 TL	10
TRS 230VAC RC 1CO 16A	230V AC	250V / 16A, 1CO	1479760000	248,25 TL	10
TRS 24-230VUC 1CO 16A	24 V.....230 VAC/dc üniversal giriş	250V / 16A, 1CO	1479770000	320,90 TL	10
<b>1 NO Kontak 16A, 12,8 mm genişlik, Inrush Power HC (Inductive Yük Uygulamaları)</b>					
TRS 24VDC 1NO HC	24V DC	250V / 16A, 1NO	1479780000	202,40 TL	10
TRS 24-230VUC 1NO HC	24 V.....230 VAC/dc üniversal giriş	250V / 16A, 1NO	1479790000	349,00 TL	10
<b>1 NO Kontak 16A, 12,8 mm genişlik, Inrush Power HCp (Capacitive Yük Uygulamaları)</b>					
TRS 24VDC 1NO HCP	24V DC	250V / 16A, 1NO	1479810000	229,95 TL	10
TRS 24-230VUC 1NO HCP	24 V.....230 VAC/dc üniversal giriş	250V / 16A, 1NO	1479830000	368,70 TL	10
<b>2 CO Kontak, 12,8 mm genişlik</b>					
TRS 24VDC 2CO	24 Vdc	250V / 2 X 8A, 2CO	1123490000	157,10 TL	10
TRS 24VUC 2CO	24 Vac/dc	250V / 2 X 8A, 2CO	1123500000	179,20 TL	10
TRS 120VUC 2CO	120 Vac/dc	250V / 2 X 8A, 2CO	1123530000	187,90 TL	10
TRS 230VUC 2CO	230 Vac/dc	250V / 2 X 8A, 2CO	1123540000	197,30 TL	10
TRS 120VAC RC 2CO	120 Vac	250V / 2 X 8A, 2CO	1123550000	232,05 TL	10
TRS 230VAC RC 2CO	230 Vac	250V / 2 X 8A, 2CO	1123570000	243,65 TL	10
TRS 24-230VUC 2CO	24 V.....230 Vac/dc üniversal giriş	250V / 2 X 8A, 2CO	1123580000	307,00 TL	10
<b>Yaylı 1 CO Kontak 6A, 6,4 mm genişlik</b>					
TRZ 24VDC 1CO	24 VDC	250V / 6A, 1CO	1122880000	98,55 TL	10
TRZ 24VUC 1CO	24V AC/DC	250V / 6A, 1CO	1122890000	144,20 TL	10
TRZ 120VUC 1CO	120V AC/DC	250V / 6A, 1CO	1122920000	180,80 TL	10
TRZ 230VUC 1CO	230V AC/DC	250V / 6A, 1CO	1122930000	189,90 TL	10
TRZ 120VAC RC 1CO	120V AC	250V / 6A, 1CO	1122940000	226,40 TL	10
TRZ 230VAC RC 1CO	230V AC	250V / 6A, 1CO	1122950000	237,70 TL	10
TRZ 24-230VUC 1CO	24 V.....230 VAC/dc üniversal giriş	250V / 6A, 1CO	1122970000	294,45 TL	10
<b>PUSH-IN 1 CO Kontak 6A, 6,4 mm genişlik</b>					
TRP 24VDC 1CO	24 VDC	250V / 6A, 1CO	2618000000	104,70 TL	10
TRP 24VUC 1CO	24V AC/DC	250V / 6A, 1CO	2618220000	137,35 TL	10
TRP 120VUC 1CO	120V AC/DC	250V / 6A, 1CO	2618010000	189,90 TL	10
TRP 230VUC 1CO	230V AC/DC	250V / 6A, 1CO	2618050000	189,90 TL	10
TRP 120VAC RC 1CO	120V AC	250V / 6A, 1CO	2618150000	237,70 TL	10
TRP 230VAC RC 1CO	230V AC	250V / 6A, 1CO	2618200000	237,70 TL	10
<b>Term Serisi Röleler için Üst Köprüler</b>					
TCC 6.4/10 OR	10 Kutuplu, Turuncu, 1 Kontak için		2556360000	40,30 TL	10
TCC 6.4/51 OR	51 Kutuplu, Turuncu, 1 Kontak için		2556370000	201,60 TL	10
TCC 6.4/10 BL	10 Kutuplu, Mavi, 1 Kontak için		2556440000	36,95 TL	10
TCC 6.4/51 BL	51 Kutuplu, Mavi, 1 Kontak için		2556450000	201,60 TL	10
TCC 6.4/10 RD	10 Kutuplu, Kırmızı, 1 Kontak için		2556400000	44,80 TL	10

Serinin devamı sayfa 108



TIA SUBD 15S



TIAL F20



TXS SUPPLY



MCZ R 24VDC



RSM 8RS 24VDC LP GEM.-



TRP T 24VDC 1CO M3



TOP 5VDC/48VDC 0,1A

Tip	Giriş	Çıkış	Sipariş No	Fiyat/Birim	Ambalaj
TCC 6.4/51 RD	51 Kutuplu, Kırmızı, 1 Kontak için		2556410000	201,60 TL	10
TCC 12.8/26 OR	26 Kutuplu, Turuncu, 2 Kontak için		2556380000	201,60 TL	10
TCC 12.8/26 BL	26 Kutuplu, Mavi, 2 Kontak için		2556460000	201,60 TL	10
TCC 12.8/26 RD	26 Kutuplu, Kırmızı, 2 Kontak için		2556420000	201,60 TL	10

#### Term Serisi Röle Aksesuarları

* RSS113024F	Term serisi için 1CO yedek röle		1454430000	93,90 TL	18
TIA SUBD 15S	8 Adet TRS Röle için 15 Kutup SUB-D bağlantı tipi PLC Adaptörü		1463530000	784,00 TL	1
TIAL F10	8 Adet TRS Röle için 10 Kutuplu PLC arayüz bağlantısı- Adaptörü		1463540000	738,00 TL	1
TIAL F20	16 Adet TRS Röle için 20 Kutuplu PLC arayüz bağlantısı- Adaptörü		1463550000	949,00 TL	1
TXS SUPPLY	Besleme Terminali		1240780000	102,40 TL	10
TW TXS/TXZ R3.2	İzolasyon plakası		1240800000	12,15 TL	10
WEW 35/2 SW	Vidalı Tip Siyah Durdurucu		1061210000	28,35 TL	100
WS 10/6 MC NE WS			1828450000	1,19 TL	600

**Not:** 1 ve 2 enversör kontaklar Vidalı ve yaylı bağlantı 6.4 ve 12.8 mm röle genişliği ZQV ile köprülenebilir. Universal giriş 24...230 V AC/DC

#### MCZ Serisi Röleler

##### 1 Enversör Kontak

MCZ R 24VDC	24 Vdc / 6,3 mA	250 V / 6 A, 1CO	8365980000	191,40 TL	10
MCZ R 24VUC	24 Vac/dc / 10,8 mA	250 V / 6 A, 1CO	8390590000	334,45 TL	10
MCZ R 120VAC	120 Vac/dc / 7 mA	250 V / 6 A, 1CO	8420880000	417,75 TL	10
MCZ R 230VAC	230 Vac / 9,5 mA	250 V / 6 A, 1CO	8237710000	438,85 TL	10

##### MCZ Röle için Nihayet Plakası

AP MCZ1.5	MCZ Nihayet Plakası		8389030000	19,60 TL	50
-----------	---------------------	--	------------	----------	----

**Not:** 1 Enversör Kontak 250 VAC/6A ,6mm Röle Genişliği ,ZQV ile Köprülenebilir, Yeşil LED

##### MCZ Serisi Röleler için Üst Köprüler

ZQV 4N/10 GE	10'lu Sarı		1758260000	51,05 TL	20
ZQV 4N/10 RT	10'lu Kırmızı		1794040000	50,50 TL	20
ZQV 4N/10 BL	10'lu Mavi		1794050000	50,50 TL	20
ZQV 4N/41	41'li Sarı		1758270000	207,55 TL	10
ZQV 4N/41 RT	41'li Kırmızı		1794070000	207,55 TL	10
ZQV 4N/41 BL	41'li Mavi		1794080000	207,55 TL	10

##### Çoklu Röle Modülü

RSM 8RS 24VDC LP GEM.-	24 Vdc / 23 mA	250 V / 6 A, 1CO	1113561001	120,00 €	1
------------------------	----------------	------------------	------------	----------	---

Tip	Açıklama	Sipariş No	Fiyat/Birim	Ambalaj
-----	----------	------------	-------------	---------

##### Term Serisi Slim Zaman Röleleri

TRS T 24VDC 1CO M3	Vidalı , 1 CO Kontak 6A, Çekmede gecikme, Flaşör, Tetiklemeli	2639560000	497,90 TL	10
TRP T 24VDC 1CO M3	PUSH-IN, 1 CO Kontak 6A, Çekmede gecikme, Flaşör, Tetiklemeli	2639730000	Sorunuz	Sorunuz

##### TFI Serisi Zaman Röleleri

TFIS 12-240VUC 1CO M7C	7 Fonsiyonlu Zaman Rölesi 0.05 s - 100 saat arası ayarlanabilir, Multi-Fonksiyon, 12 - 240 V AC/DC	2697250000	655,00 TL	1
TFIS 12-240VUC 2NO SD	Yıldız Üçgen Röle 2 NO Kontak, 12 - 240 V AC/DC	2697270000	782,00 TL	1
TFIS 24-240VUC 1CO ON	Çekme gecikmeli, 1 CO Kontak, 12 - 240 V AC/DC	2697280000	595,00 TL	1
TFIS 24-240VUC 1CO OFFC	Bırakma gecikmeli, 1 CO Kontak, 12 - 240 V AC/DC	2697290000	595,00 TL	1

Tip	Giriş	Çıkış	Sipariş No	Fiyat/Birim	Ambalaj
-----	-------	-------	------------	-------------	---------

##### Termopto Serisi Optokuplörler

##### 100 mA DC Çıkış

TOP 5VDC/48VDC 0,1A	5 Vdc	5...48 Vdc / 0,1 A	8950760000	148,40 TL	10
---------------------	-------	--------------------	------------	-----------	----

Serinin devamı sayfa 109

Tip	Giriş	Çıkış	Sipariş No	Fiyat/Birim	Ambalaj
TOP 24VDC/48VDC 0,1A	24 Vdc	5...48 Vdc / 0,1 A	8950780000	148,40 TL	10
TOP 24VAC/48VDC 0,1A	24 Vac	5...48 Vdc / 0,1 A	8950860000	154,20 TL	10
TOP 120VAC/48VDC 0,1A	120 Vac	5...48 Vdc / 0,1 A	8950880000	168,95 TL	10
TOP 230VAC/48VDC 0,1A	230 Vac	5...48 Vdc / 0,1 A	8950890000	184,95 TL	10
<b>500 mA DC Çıkış</b>					
TOP 5VDC/48VDC 0,5A	5 Vdc	5...48 Vdc / 0,5 A	8950960000	185,70 TL	10
TOP 24VDC/48VDC 0,5A	24 Vdc	5...48 Vdc / 0,5 A	8950980000	185,70 TL	10
TOP 24VAC/48VDC 0,5A	24 Vac	5...48 Vdc / 0,5 A	8951060000	191,40 TL	10
TOP 120VAC/48VDC 0,5A	120 Vac	5...48 Vdc / 0,5 A	8951080000	204,70 TL	10
TOP 230VAC/48VDC 0,5A	230 Vac	5...48 Vdc / 0,5 A	8951090000	216,60 TL	10
<b>100 mA AC Çıkış</b>					
TOP 5VDC/230VAC 0,1A	5 Vdc	24...230 Vac / 0,1 A	8951160000	284,60 TL	10
TOP 24VDC/230VAC 0,1A	24 Vdc	24...230 Vac / 0,1 A	8951180000	284,60 TL	10
TOP 24VAC/230VAC 0,1A	24 Vac	24...230 Vac / 0,1 A	8951260000	293,70 TL	10
TOP 120VAC/230VAC 0,1A	120 Vac	24...230 Vac / 0,1 A	8951280000	307,15 TL	10
TOP 230VAC/230VAC 0,1A	230 Vac	24...230 Vac / 0,1 A	8951290000	319,65 TL	10
<b>4 A DC Çıkış</b>					
TOS 24VDC/24VDC 4A	24 Vdc	3...33Vdc / 4 A	1275100000	256,80 TL	10
<b>Termopto Serisi Optokuplörler İçin Üst Köprüler</b>					
ZQV 4N/10 GE	10'lu Sarı		1758260000	51,05 TL	20
ZQV 4N/10 RT	10'lu Kırmızı		1794040000	50,50 TL	20
ZQV 4N/10 BL	10'lu Mavi		1794050000	50,50 TL	20
ZQV 4N/41	41'li Sarı		1758270000	207,55 TL	10
ZQV 4N/41 RT	41'li Kırmızı		1794070000	207,55 TL	10
ZQV 4N/41 BL	41'li Mavi		1794080000	207,55 TL	10
<b>Not: Push In bağlantı teknolojisi ile Termopto Serisi Optokuplörler elektromekanik rölelere alternatiftir.</b>					
<b>Term Serisi Solid-State Röleler</b>					
<b>100 mA DC Çıkış, 6,4 mm genişlik</b>					
TOS 24-230VUC 48VDC0,1A	24 V...230 Vac/dc universal giriş	0...48 Vdc / 100 mA	1127020000	381,60 TL	10
TOS 24VDC 48VDC0,1A	24 Vdc	0...48 Vdc / 100 mA	1126940000	210,55 TL	10
TOS 24VUC 48VDC0,1A	24 Vac/dc	0...48 Vdc / 100 mA	1126950000	222,90 TL	10
TOS 120VUC 48VDC0,1A	120 Vac/dc	0...48 Vdc / 100 mA	1126980000	263,20 TL	10
TOS 230VUC 48VDC0,1A	230 Vac/dc	0...48 Vdc / 100 mA	1126990000	260,10 TL	10
TOS 120VAC RC 48VDC0,1A	120 Vac	0...48 Vdc / 100 mA	1127000000	305,65 TL	10
TOS 230VAC RC 48VDC0,1A	230 Vac	0...48 Vdc / 100 mA	1127010000	305,65 TL	10
<b>2 A DC Çıkış, 6,4 mm genişlik</b>					
TOS 24-230VUC 24VDC2A	24 V...230 Vac/dc universal giriş	0...24 Vdc / 2A	1127250000	469,05 TL	10
TOS 24VDC 24VDC2A	24 Vdc	0...24 Vdc / 2A	1127170000	220,80 TL	10
TOS 24VUC 24VDC2A	24 Vac/dc	0...24 Vdc / 2A	1127180000	308,50 TL	10
TOS 120VUC 24VDC2A	120 Vac/dc	0...24 Vdc / 2A	1127210000	339,35 TL	10
TOS 230VUC 24VDC2A	230 Vac/dc	0...24 Vdc / 2A	1127220000	339,35 TL	10
TOS 120VAC RC 24VDC2A	120 Vac	0...24 Vdc / 2A	1127230000	384,10 TL	10
TOS 230VAC RC 24VDC2A	230 Vac	0...24 Vdc / 2A	1127240000	392,95 TL	10
<b>1 A AC Çıkış, 6,4 mm genişlik</b>					
TOS 24-230VUC 230VAC1A	24 V...230 Vac/dc universal giriş	24...240 Vac / 1A	1127500000	469,05 TL	10
TOS 24VDC 230VAC1A	24V DC	24...240 Vac / 1A	1127410000	300,35 TL	10
TOS 24VUC 230VAC1A	24V AC/DC	24...240 Vac / 1A	1127420000	316,30 TL	10
TOS 120VUC 230VAC1A	120V AC/DC	24...240 Vac / 1A	1127450000	339,35 TL	10
TOS 230VUC 230VAC1A	230V AC/DC	24...240 Vac / 1A	1127470000	347,15 TL	10
TOS 120VAC RC 230VAC1A	120V AC	24...240 Vac / 1A	1127480000	384,10 TL	10
TOS 230VAC RC 230VAC1A	230V AC	24...240 Vac / 1A	1127490000	392,95 TL	10



ZQV 4N/10 GE



TOS 24-230VUC 48VDC0,1A



TOS 24VUC 230VAC1A





TXS SUPPLY



ZQV 4N/10 GE



MOS 24VDC/5-33VDC 10A



PSSR 24VDC/1PH AC 25A

Tip	Giriş	Çıkış	Sipariş No	Fiyat/Birim	Ambalaj
<b>3,5 A DC Çıkış, 12,8 mm genişlik</b>					
TOS 24-230VUC 24VDC3,5A	24 V....230 VAC/DC üniversal giriş	0...33 Vdc / 3,5A	1127640000	562,00 TL	10
TOS 24VDC 24VDC3,5A	24V DC	0...33 Vdc / 3,5A	1127630000	349,20 TL	10
<b>1 A AC Çıkış, 12,8 mm genişlik</b>					
TOS 24-230VUC 230VAC1A	24 V....230 VAC/DC üniversal giriş	12...275 Vac / 1A	1127690000	548,00 TL	10
TOS 24VDC 230VAC1A	24V DC	12...275 Vac / 1A	1127680000	349,20 TL	10
<b>5 A DC Çıkış, 12,8 mm genişlik</b>					
TOS 24VDC 24VDC5A	24V DC	3...33V DC 5A	1990960000	398,00 TL	10
TOS 24-230VUC 24VDC5A	24 V....230 VAC/DC üniversal giriş	3...33V DC 5A	1990970000	829,00 TL	10
<b>Term Serisi Solid - State Aksesuarları</b>					
TXS SUPPLY	Besleme Terminali		1240780000	102,40 TL	10
TW TXS/TXZ R3.2	İzolasyon plakası		1240800000	12,15 TL	10
WEW 35/2 SW	Vidalı Tip Siyah Durdurucu		1061210000	28,35 TL	100
WS 10/6 MC NE WS	Markalama		1828450000	1,19 TL	600
<b>Not: 100 mA'den 5 A'e kadar ,Vidalı ve yaylı bağlantı, 6,4 mm ve 12,8 mm röle genişliği, Üniversal giriş 24...230 Vac/dc</b>					
<b>Term Serisi Solid-State Röleler için Üst Köprüler</b>					
<b>Term Serisi Röleler için Üst Köprüler</b>					
TCC 6.4/10 OR	10 Kutuplu, Turuncu, 1 Kontak için		2556360000	40,30 TL	10
TCC 6.4/51 OR	51 Kutuplu, Turuncu, 1 Kontak için		2556370000	201,60 TL	10
TCC 12.8/26 OR	26 Kutuplu, Turuncu, 2 Kontak için		2556380000	201,60 TL	10
<b>Micro Serisi Optokuplörler için Üst Köprüler</b>					
ZQV 4N/10 GE	10'lu Sarı		1758260000	51,05 TL	20
ZQV 4N/10 RT	10'lu Kırmızı		1794040000	50,50 TL	20
ZQV 4N/10 BL	10'lu Mavi		1794050000	50,50 TL	20
ZQV 4N/41	41'li Sarı		1758270000	207,55 TL	10
ZQV 4N/41 RT	41'li Kırmızı		1794070000	207,55 TL	10
ZQV 4N/41 BL	41'li Mavi		1794080000	207,55 TL	10
<b>Özel Uygulamalar için Micro Opto Serisi Optokuplörler</b>					
<b>10 A Selonoid Sürücü</b>					
MOS 24VDC/5-33VDC 10A	24 Vdc	5...33 Vdc / 10 A	8937940000	560,00 TL	1
<b>Direkt Aktüatör Bağlantısı için</b>					
MOS 24VDC/8-30VDC 2A	24 Vdc	8...30 Vdc / 2 A	8937970000	599,00 TL	1
<b>300 VDC'ye Kadar İndüktif Yükler için</b>					
MOS 24VDC/12-300VDC 1A	24 Vdc	12...300 Vdc / 1 A	8937830000	566,00 TL	1
<b>1 kHz Elektronik Anahtarlama</b>					
MOS 24VDC/5-48VDC 0,5A	24 Vdc	5...48 Vdc / 500 mA	8937980000	372,30 TL	1
<b>100 kHz Yüksek Anahtarlama Frekansı</b>					
MOS 12-28VDC 100kHz	12...28 Vdc	24 Vdc / 50 mA	8937990000	436,80 TL	1
<b>100 kHz TTL Sinyalden Dönüştürme</b>					
MOS 5VTTL/24VDC 0,1A	5 V TTL	19.6...28.8 V / 100 mA	8937920000	369,60 TL	1
<b>100 kHz TTL Sinyale Dönüştürme</b>					
MOS 12-28VDC/5VTTL	12...28 Vdc	5 V TTL / 50 mA	8937930000	369,60 TL	1
<b>PSSR Serisi Güç Solid-state Röleleri</b>					
PSSR 24VDC/1PH AC 25A	1 Faz AC, 24VDC, 25A		1406200000	75,00 €	1
PSSR 230VAC/1PH AC 25A	1 Faz AC, 230VAC, 25A		1406220000	67,50 €	1
PSSR 24VDC/1PH AC 35A	1 Faz AC, 24VDC, 35A		1406210000	95,50 €	1



SCS 24VDC P1SIL3DS

Tip	Giriş	Çıkış	Sipariş No	Fiyat/Birim	Ambalaj
<b>Güvenlik Röleleri (24V DC SIL 3 DN EN 61508)</b>					
SCS 24VDC P1SIL3DS	24 Vdc giriş; 1NO Kontak, Güvenlik Kategorisi: SIL3 DIN EN61508		1303890000	96,50 €	1
SCS 24VDC P1SIL3DS M	24 Vdc giriş; 1NO Kontak, İzleme Devreli, Güvenlik Kategorisi: SIL3 DIN EN61508		1303760000	131,00 €	1
SCS 24VDC P1SIL3DS MG3	24 Vdc giriş; 1NO Kontak, İzleme Devreli, Güvenlik Kategorisi: SIL3 DIN EN61508, G3 Seviye koruyucu		1304040000	163,00 €	1
SCS 24VDC P2SIL3DSES	24 Vdc giriş; 1NO+1NC Kontak, Güvenlik Kategorisi: SIL3 DIN EN61508		1319270000	160,00 €	1
SCS 24VDC P2SIL3ES	24 Vdc giriş; 2NO+1NC pozitif anahtarlamalı kontak, Güvenlik Kategorisi: SIL3 DIN EN61508		1319280000	170,00 €	1
SCS 24VDC P1SIL3DS I	24 Vdc giriş; 1NO kontak, Güvenlik Kategorisi: SIL3 DIN EN61508(Schneider Electric Triconex® System için)		2500980000	100,00 €	1



## Analog Sinyal Dönüştürücüler

Analog sinyal dönüştürücüler petrol, kimya, enerji, su arıtma, çimento ve demir çelik gibi birçok endüstri ve proses otomasyonunda kullanılmaktadırlar. Üretim prosesinde sıcaklık, basınç, akış miktarı, boş/dolu uygulamaları, ağırlık ve hız gibi parametrelerin ölçülüp denetlenmesi gerektiğinde kullanılırlar. Ölçülen sinyaller, proses zincirinde dış etkilerden etkilenmeden ve uzun mesafelerde gönderilmelidirler. Kararlılık ısı, elektromanyetik dalgalar, titreşim, paslanma gibi etkenlerden etkilenmemelidir. Patlama tehlikesi olan ortamlarda sinyal alışverişi devam etmelidir.

Aşağıdaki özelliklere sahiptirler:

- Sinyallerin galvanik izolasyonu
- Gelen sinyalin başka bir sinyale dönüştürülmesi
- Kuvvetlendirme, lineerleştirme, dönüştürme.
- Düşük sensör sinyallerinin hiçbir kayıp olmadan yukarılara taşınması
- Opsiyonel durum göstergeleri ve alarm kontakları dönüştürme prosesinin takip edilmesini sağlar.

Dönüştürücü ürün gurubu şu dönüştürme ve izolasyon fonksiyonlarını yerine getirebilir:

- DC/DC-Dönüştürme
- Gerilim
- Akım
- Sıcaklık-RTD ve Termokuplör
- Frekans
- Loadcell
- Potansiyometre
- AC-gerilim ve akım izleme
- Alarm (Sınır değeri)
- AD/DA-çeviriciler

Bu ürün grupları, 2-yollu izolasyonlu, 3-yollu izolasyonlu, aktif veya pasif dönüştürücü olarak mevcuttur.





ACT20P-BRIDGE-S



ACT20P-CI-2CO



ACT20P-AI-AO-DC-S



ACT20P-CMT-10-AO-RC-S

Tip	Giriş	Çıkış	Sipariş No	Fiyat/Birim	Ambalaj
<b>ACT20P Serisi - Universal Dönüştürücüler</b>					
<b>Ayarlanabilir Load Cell Dönüştürücü</b>					
ACT20P-BRIDGE-S	Load Cell	1 x 0...22 mA, 0...11 V	1067250000	381,00 €	1
<b>Hart Protokol Sinyal Dönüştürücüler</b>					
ACT20P-CI-2CO	1 x 0(4)...20 mA 2/3 Kablolu, HART Sinyal	2 x 0(4)...20 mA	7760054115	260,00 €	1
ACT20P-2CI-2CO-12	2 x 0(4)...20 mA 2/3 Kablolu, HART Sinyal	2 x 0(4)...20 mA	7760054117	275,00 €	1
<b>Ayarlanabilir Universal Limit Değer İzleme Modülleri</b>					
ACT20P-UI-2RCO-DC-S*	1 x Universal giriş, akım, voltaj, direnc, sıcaklık sensörü	2 x CO Röle Çıkışı	7940045760	387,00 €	1
ACT20P-PRO-RTCI-AO-DO-S	1 x Potansiyometre: 0 - 120k $\Omega$ , Direnc: 0 - 15k $\Omega$ , RTD Sensörleri	1 x DO: Ayarlanabilir alarm fonksiyonu, AO: Ayarlana- bilir voltaj; 0..5V, 0..10V, $\pm$ 5V, $\pm$ 10V, akım; $\pm$ 20mA, $\pm$ 10mA, 0..20mA	2448100000	340,00 €	1
<b>Not: *Ürünün programlanabilmesi için 8978580000 kodlu CBX200 USB programlama kablosu gerekmektedir</b>					
<b>Ayarlanabilir Universal Limit Değer İzleme Modülleri, Çıkış Döngü Beslemeli</b>					
ACT20P-UI-AO-DO-LP-S*	1 x Universal giriş, akım, voltaj, direnc, sıcaklık sensörü	1 x DO: Ayarlanabilir alarm fonksiyonu, AO: 4...20 mA	1453210000	320,00 €	1
<b>Ayarlanabilir Universal DC/DC Dönüştürücü Modülleri</b>					
ACT20P-AI-AO-DC-S	1 x 0...22 mA, 0...11 V	1 x 0...22 mA, 0...11 V	1477420000	330,00 €	1
ACT20P-PRO DCDC II-S	1 x $\pm$ 0.1mA... $\pm$ 100 mA, $\pm$ 40 mV... $\pm$ 300 V $\pm$ 0.1mA... $\pm$ 100 mA	1 x 0... $\pm$ 20 mA, 0... $\pm$ 10 V	1481970000	380,00 €	1
<b>DC/DC Dönüştürücü Modülleri</b>					
ACT20P-CI-VO	1 x 0(4)...20 mA, 2/3 kablolu bağlantı	1 x 0...10 V, 2...10 V	1540010000	165,00 €	1
<b>DC/DC Dönüştürücü Modülleri, Çıkış Döngü Beslemeli</b>					
ACT20P-VI-CO-OLP	1 x 0...10 V	1 x 4...20 mA	7760054121	200,00 €	1
ACT20P-VI1-CO-OLP	1 x 0...5 V	1 x 4...20 mA	7760054120	158,00 €	1
<b>DC/DC Pasif İzolasyon Modülleri, Çıkış Döngü Beslemeli</b>					
ACT20P-CI2-CO-OLP	1 x 4...20 mA	1 x 4...20 mA	7760054119	200,00 €	1
<b>DC/DC Pasif İzolasyon Modülleri, Çıkış Döngü Beslemeli, Çoklayıcı</b>					
ACT20P-CI-2CO-OLP	1 x 4...20 mA	2 x 4...20 mA	7760054122	210,00 €	1
<b>DC/DC Pasif İzolasyon Modülleri, Giriş Döngü Beslemeli</b>					
ACT20P-CI-CO-ILP	1 x 0(4)...20 mA	1 x 0(4)...20 mA	7760054123	150,00 €	1
ACT20P-2CI-2CO-ILP	2 x 0(4)...20 mA	2 x 0(4)...20 mA	7760054124	230,00 €	1
<b>UC/DC Dönüştürücü Modülleri</b>					
ACT20P-CMT-10-AO-RC-S	1 x 0...1/5/10 A AC/DC Hall Sensor	1 x 0(4)...20 mA, $\pm$ 20 mA 0...10 V, 2...10 V, 0...5 V, 1...5 V, $\pm$ 5 V $\pm$ 10 V, Röle Alarm Çıkışı	1510470000	280,00 €	1
ACT20P-CMT-30-AO-RC-S	1 x 0...20/25/30 A AC/DC Hall Sensor	1 x 0(4)...20 mA, $\pm$ 20 mA 0...10 V, 2...10 V, 0...5 V, 1...5 V, $\pm$ 5 V $\pm$ 10 V, Röle Alarm Çıkışı	1510540000	260,00 €	1
ACT20P-CMT-60-AO-RC-S	1 x 0...40/50/60 A AC/DC Hall Sensor	1 x 0(4)...20 mA, $\pm$ 20 mA 0...10 V, 2...10 V, 0...5 V, 1...5 V, $\pm$ 5 V $\pm$ 10 V, Röle Alarm Çıkışı	1510440000	290,00 €	1

Serinin devamı sayfa 115

Tip	Giriş	Çıkış	Sipariş No	Fiyat/Birim	Ambalaj
ACT20P-CML-10-AO-RC-S	1 x 0...1/5/10 A AC/DC Terminal Bağlantısı	1 x 0(4)...20 mA, ±20 mA, 0...10 V, 2...10 V, 0...5 V, 1...5 V, ±5 V, ±10 V, Röle Alarm Çıkışı	2044850000	240,00 €	1
ACT20P-VM-AO-S*	1 x 0...440 V AC, 0...660 V DC ayarlanabilir	1 x 0(4)...20 mA, 0...10 V	7760054306	255,00 €	1
<b>Akım İzleme Modülleri</b>					
ACT20P-CMT-60-RC-S	1 x 0...40/50/60 A AC/DC Hall Sensor	1 x CO Röle Çıkışı	1510390000	220,00 €	1
<b>Gerilim İzleme Modülleri, 1 Faz</b>					
ACT20P-VMR-1PH-H	1 x 110/240/400 V AC/DC ayarlanabilir	2 x CO Röle Çıkışı	7760054164	200,00 €	1
<b>Gerilim İzleme Modülleri, 3 Faz, Giriş Döngü Beslemeli</b>					
ACT20P-VMR-3PH-ILP-H	3 x 180...500 V AC	2 x CO Röle Çıkışı	7760054165	220,00 €	1
<b>Not: *Ürünün programlanabilmesi için 8978580000 kodlu CBX200 USB programlama kablosu gerekmektedir</b>					
<b>Sıcaklık İzleme Modülleri</b>					
ACT20P-TMR-RTI-S*	1 x PT100 2/3/4 kablolu, PTC: 0-4kΩ	2 x CO Röle Çıkışı	7760054305	230,00 €	1
<b>Not: *Ürünün programlanabilmesi için 8978580000 kodlu CBX200 USB programlama kablosu gerekmektedir</b>					
<b>ACT20C Serisi - Ethernet Arabirimli Dönüştürücüler</b>					
ACT20C-GTW-100-MTCP-S*	Ethernet Gateway Modülü		1510370000	466,00 €	1
SET CH20M BUS 250MM TS 35X7.5	ACT 20C Haberleşme bus terminal seti / 250 mm		1335140000	1.090,00 TL	1
ACT20C-LBT-10	ACT 20C Bus termination durdurucu aparatı		1510340000	93,20 €	1
ACT20-FEED-IN-BASIC-S	Raydan besleme modülü / 0.5 - 2.5 A		1282490000	63,00 €	1
ACT20-FEED-IN-PRO-S	Raydan besleme modülü / 4 A		8965500000	209,00 €	1
<b>Not: *Ürünün programlanabilmesi için 8978580000 kodlu CBX200 USB programlama kablosu gerekmektedir</b>					
<b>UC/DC Dönüştürücü Modülleri</b>					
ACT20C-CML-10-AO-RC-S*	1 x 0...5/10 A UC Terminal Bağlantısı	1 x 0(4)...20 mA, ±20 mA, 0...10 V, 2...10 V, 0...5 V, 1...5 V, ±5 V, ±10 V, Röle Alarm Çıkışı	2044840000	300,00 €	1
ACT20C-CMT-10-AO-RC-S*	1 x 0...5/10 A UC Hall Sensor	1 x 0(4)...20 mA, ±20 mA, 0...10 V, 2...10 V, 0...5 V, 1...5 V, ±5 V, ±10 V, Röle Alarm Çıkışı	1510240000	272,00 €	1
ACT20C-CMT-60-AO-RC-S*	1 x 0...40/50/60 A UC Hall Sensor	1 x 0(4)...20 mA, ±20 mA, 0...10 V, 2...10 V, 0...5 V, 1...5 V, ±5 V, ±10 V, Röle Alarm Çıkışı	1510420000	272,00 €	1
<b>Not: *Ürünün programlanabilmesi için 8978580000 kodlu CBX200 USB programlama kablosu gerekmektedir</b>					
<b>ACT20M Serisi - Slim Seri Dönüştürücüler</b>					
<b>DC/DC Pasif İzolasyon Modülleri, Giriş Döngü Beslemeli</b>					
ACT20M-CI-CO-ILP-S	1 x 0(4)...20 mA	1 x 0(4)...20 mA	1176070000	180,00 €	1
ACT20M-2CI-2CO-ILP-S	2 x 0(4)...20 mA	2 x 0(4)...20 mA	1176080000	330,00 €	1
<b>DC/DC Pasif İzolasyon Modülleri, Çıkış Döngü Beslemeli</b>					
ACT20M-CI-CO-OLP-S	1 x 4...20 mA	1 x 0(4)...20 mA	1176040000	210,00 €	1
ACT20M-2CI-2CO-OLP-S	2 x 4...20 mA	2 x 4...20 mA	1176050000	330,00 €	1
<b>Ayarlanabilir Universal DC/DC Dönüştürücü Modülleri</b>					
ACT20M-CI-CO-S	1 x 0(4)...20 mA	1 x 0(4)...20 mA	1175980000	195,00 €	1



ACT20C-GTW-100-MTCP-S\*



ACT20C-LBT-10



ACT20M-CI-CO-ILP-S



ACT20M-BAI-AO-S



CBX200 USB



ACT20X-SAI-HAO-S\*

Tip	Giriş	Çıkış	Sipariş No	Fiyat/Birim	Ambalaj
ACT20M-AI-AO-E-S	1 x 0(4)...20 mA, 0(2)...10 V, 0(1)...5 V	1 x 0(4)...20 mA, 0(2)...10 V, 0(1)...5 V	1176010000	185,00 €	1
ACT20M-AI-AO-S	1 x 0(4)...20 mA, 0(2)...10 V, 0(1)...5 V ( Sensör Beslemesi: 17...28 V DC )	1 x 0(4)...20 mA, 0(2)...10 V, 0(1)...5 V	1176000000	206,00 €	1
ACT20M-BAI-AO-S	1 x ±10 mA, ±20 mA ±5 V, ±10 V	1 x 0(4)...20 mA, 0(2)...10 V, 0(1)...5 V	1375450000	186,00 €	1
ACT20M-UI-AO-S*	1 x 0(4)...20 mA, 0(2)...10 V, 0(1)...5 V 10 Ω...10 kΩ, RTD, TC	1 x 0(4)...20 mA, 0(2)...10 V, 0(1)...5 V	1176030000	320,00 €	1

### Ayarlanabilir Universal DC/DC Dönüştürücü Modülleri, Çoklayıcı

ACT20M-CI-2CO-S	1 x 0(4)...20 mA	2x 0(4)...20 mA	1175990000	285,00 €	1
ACT20M-AI-2AO-S	1 x 0(4)...20 mA, 0(2)...10 V, 0(1)...5 V ( Sensör Beslemesi: 17...28 V DC )	2 x 0(4)...20 mA, 0(2)...10 V, 0(1)...5 V	1176020000	331,00 €	1
ACT20M-BAI-2AO-S	1 x ±10 mA, ±20 mA ±5 V, ±10 V	2 x 0(4)...20 mA, ± 10mA, ± 20mA 0(2)...10 V, 0(1)...5 V	1375470000	300,00 €	1

### Sıcaklık Dönüştürücü Modülleri, Galvanik izolasyonlu

ACT20M-RTI-AO-S	1 x PT100 -200...+850 °C 2/3/4 kablolu	1 x 0(4)...20 mA, 0(2)...10 V, 0(1)...5 V	1375510000	170,00 €	1
ACT20M-TCI-AO-S	1 x TC J -100...+1200°C, TCK -200...+1370°C	1 x 0(4)...20 mA, 0(2)...10 V, 0(1)...5 V	1375480000	185,00 €	1

### Sıcaklık Dönüştürücü Modülleri, Galvanik izolasyonlu, Çıkış Döngü Beslemeli

ACT20M-RTCI-CO-OLP-S	1 x PT100 -200...+850 °C 2/3/4 kablolu TC J -100...+1200°C, TC K -200...+1370°C	1 x 4...20 mA, 20...4 mA	1435590000	210,00 €	1
----------------------	--	--------------------------	------------	----------	---

### Sıcaklık Dönüştürücü Modülleri

ACT20M-RTI-AO-E-S	1 x PT100 -200...+850 °C 2/3/4 kablolu	1 x 0(4)...20 mA, 0(2)...10 V, 0(1)...5 V	1375520000	145,00 €	1
-------------------	---	---	------------	----------	---

### Sıcaklık Dönüştürücü Modülleri, Çıkış Döngü Beslemeli

ACT20M-RTI-CO-EOLP-S	1 x PT100 -200...+850 °C 2/3/4 kablolu TC J -100...+1200°C, TC K -200...+1370°C	1 x 4...20 mA, 20...4 mA	1435610000	147,00 €	1
----------------------	--	--------------------------	------------	----------	---

**Not:** \*Ürünün programlanabilmesi için 8978580000 kodlu CBX200 USB programlama kablosu gerekmektedir

### Programlama Kablosu

CBX200 USB	Programlama Kablosu	8978580000	120,00 €	1
------------	---------------------	------------	----------	---

### ACT20X Serisi - Ex-Proof Dönüştürücüler

#### HART Protokol DC/DC İzolasyon Modülleri

ACT20X-SAI-HAO-S*	1 x 4...20 mA	1 x 4...20 mA	8965450000	235,00 €	1
ACT20X-2SAI-2HAO-S*	2 x 4...20 mA	2 x 4...20 mA	8965460000	380,00 €	1
ACT20X-HAI-SAO-S*	1 x 4...20 mA (Sensör Beslemesi: 3.8...26 V DC)	1 x 4...20 mA	8965430000	240,00 €	1
ACT20X-2HAI-2SAO-S*	2 x 4...20 mA (Sensör Beslemesi: 3.8...26 V DC)	2 x 4...20 mA	8965440000	328,00 €	1

**Not:** \*Ürünün programlanabilmesi için 8978580000 kodlu CBX200 USB programlama kablosu gerekmektedir

### Ayarlanabilir Universal Dönüştürücü Modülleri

ACT20X-HUI-SAO-S*	1 x Universal giriş, ayarlanabilir akım, voltaj, direnç, sıcaklık sensörü	1 x 0...23 mA	8965490000	390,00 €	1
-------------------	---	---------------	------------	----------	---

Tip	Giriş	Çıkış	Sipariş No	Fiyat/Birim	Ambalaj
<b>Not: *Ürünün programlanabilmesi için 8978580000 kodlu CBX200 USB programlama kablosu gerekmektedir</b>					
<b>Ayarlanabilir Universal Dönüştürücü Modülleri, Çıkış Döngü Beslemeli</b>					
ACT20X-HUI-SAO-LP-S*	1 x Universal giriş, ayarlanabilir akım, voltaj, direnç, sıcaklık sensörü	1 x 4...20 mA	1318220000	470,00 €	1
<b>Not: *Ürünün programlanabilmesi için 8978580000 kodlu CBX200 USB programlama kablosu gerekmektedir</b>					
<b>Sıcaklık Dönüştürücü Modülleri</b>					
ACT20X-HTI-SAO-S*	1 x Universal giriş, ayarlanabilir akım, sıcaklık sensörü	1 x 0(4)...20, 20...4 mA	8965470000	370,00 €	1
ACT20X-2HTI-2SAO-S*	2 x Universal giriş, ayarlanabilir akım, sıcaklık sensörü	2 x 0(4)...20 / 20...4 mA	8965480000	513,00 €	1
<b>Not: *Ürünün programlanabilmesi için 8978580000 kodlu CBX200 USB programlama kablosu gerekmektedir</b>					
<b>Namur İzolasyon Modülleri, Röle Çıkışlı</b>					
ACT20X-HDI-SDO-RNO-S*	1 x Namur 8V DC/ 8 mA / 0...5 kHz	1 x NO Röle Çıkışı / Alarm	8965340000	165,00 €	1
ACT20X-HDI-SDO-RNC-S*	1 x Namur 8V DC/ 8 mA / 0...5 kHz	1 x NC Röle Çıkışı / Alarm	8965350000	171,00 €	1
ACT20X-2HDI-2SDO-RNO-S*	2 x Namur 8V DC/ 8 mA / 0...5 kHz	2 x NO Röle Çıkışı / Alarm	8965370000	240,00 €	1
ACT20X-2HDI-2SDO-RNC-S*	2 x Namur 8V DC/ 8 mA / 0...5 kHz	2 x NC Röle Çıkışı / Alarm	8965380000	226,00 €	1
<b>Not: *Ürünün programlanabilmesi için 8978580000 kodlu CBX200 USB programlama kablosu gerekmektedir</b>					
<b>Namur İzolasyon Modülleri, Transistör Çıkışlı</b>					
ACT20X-HDI-SDO-S*	1 x Namur 8V DC/ 8 mA / 0...5 kHz	1 x NC NPN Transistor / Alarm	8965360000	177,00 €	1
ACT20X-2HDI-2SDO-S*	2 x Namur 8V DC/ 8 mA / 0...5 kHz	2 x NC NPN Transistor / Alarm	8965390000	260,00 €	1
<b>Not: *Ürünün programlanabilmesi için 8978580000 kodlu CBX200 USB programlama kablosu gerekmektedir</b>					
<b>Ateşleme Korumalı Selenoid Sürücü Modülleri</b>					
ACT20X-SDI-HDO-L-S*	1 x NPN, PNP / ≤28 V DC	1 x NC Röle, Selenoid Driver	8965400000	193,00 €	1
<b>Not: *Ürünün programlanabilmesi için 8978580000 kodlu CBX200 USB programlama kablosu gerekmektedir</b>					
<b>Ateşleme Korumalı Selenoid Sürücü</b>					
ACT20X-2SDI-2HDO-S*	2 x NPN, PNP / ≤28 V DC	2 x NC Röle, Selenoid Driver	8965420000	280,00 €	1
ACT20X-SDI-HDO-H-S*	1 x NPN, PNP / ≤28 V DC	1 x NC Röle, Selenoid Driver	8965410000	217,00 €	1
<b>Not: *Ürünün programlanabilmesi için 8978580000 kodlu CBX200 USB programlama kablosu gerekmektedir</b>					
<b>EPAK - Ekonomik Seri Dönüştürücüler</b>					
<b>DC/DC İzolasyon Modülleri</b>					
EPAK-CI-CO	1 x 0(4)...20 mA	1 x 0(4)...20 mA	7760054181	92,00 €	1
EPAK-PCI-CO	1 x 0(4)...20 mA (Sensör beslemesi: 22...30 V DC)	1 x 0(4)...20 mA	7760054182	94,00 €	1
EPAK-VI-VO	1 x 0...10 V	1 x 0...10 V	7760054175	127,00 €	1
<b>DC/DC Pasif İzolasyon Modülleri, Giriş Döngü Beslemeli</b>					
EPAK-CI-CO-ILP	1 x 4...20 mA	1 x 4...20 mA	7760054179	83,00 €	1
EPAK-2CI-2CO-ILP	2 x 4...20 mA	2 x 4...20 mA	7760054180	99,00 €	1
<b>DC/DC Dönüştürücü Modülleri</b>					
EPAK-CI-VO	1 x 4...20 mA	1 x 0...10 V	7760054176	144,00 €	1
EPAK-PCI-VO	1 x 0(4)...20 mA (Sensör beslemesi: 22...30 V DC)	1 x 0...10 V	7760054177	138,00 €	1
EPAK-VI-CO	1 x 0...10 V	1 x 4...20 mA	7760054178	121,00 €	1
<b>DC/DC Sinyal Çoklayıcı Modülleri</b>					
EPAK-CI-2CO	1 x 0(4)...20 mA	2 x 0(4)...20 mA	7760054307	125,00 €	1



ACT20X-2HDI-2SDO-RNO-S\*



EPAK-2CI-2CO-ILP

Serinin devamı sayfa 118





PICOPAK-CI-CO-LP-P



MCZ CCC 0-20mA/0-20mA



JPR 24VDC 1CO M12



JPOVP RJ45 CAT6 IP20



JPO 24VDC 0.2A M12S



JP TEST



JP CLIP M

Tip	Giriş	Çıkış	Sipariş No	Fiyat/Birim	Ambalaj
EPAK-CI-4CO	1 x 0(4)...20 mA	4 x 0(4)...20 mA	7760054308	145,00 €	1

### UC/DC Dönüştürücü Modülleri

EPAK-CM-CO-H	1 x 0...1/5 A AC/DC	1 x 4...20 mA	7760054300	135,00 €	1
EPAK-VM-CO-H	1 x 0...300 V AC/DC, 0...125 V AC, 0...30 V DC	1 x 4...20 mA	7760054299	132,00 €	1

### Akım İzleme Modülleri, 1 Faz, 24 V Besleme

EPAK-CM-R-1PH-5-24V	1 x 0...1/5 A AC/DC	1 x CO Alarm Çıkışı	7760054246	120,00 €	1
---------------------	---------------------	---------------------	------------	----------	---

### Akım İzleme Modülleri, 1 Faz, 230 V Besleme

EPAK-CM-R-1PH-5-230V	1 x 0...1/5 A AC/DC	1 x CO Alarm Çıkışı	7760054247	144,00 €	1
----------------------	---------------------	---------------------	------------	----------	---

### Gerilim İzleme Modülleri, 1 Faz, 24 V Besleme

EPAK-CM-R-1PH-300-24V	1 x 30...300 AC/DC, 6...60 V AC/DC	1 x CO Alarm Çıkışı	7760054244	154,00 €	1
-----------------------	------------------------------------	---------------------	------------	----------	---

### Gerilim İzleme Modülleri, 1 Faz, 230 V Besleme

EPAK-CM-R-1PH-300-230V	1 x 30...300 AC/DC, 6...60 V AC/DC	1 x CO Alarm Çıkışı	7760054245	176,00 €	1
------------------------	------------------------------------	---------------------	------------	----------	---

### Gerilim İzleme Modülleri, 3 Faz

EPAK-CM-R-3PH-PH	3 x 400V AC (L-L)	1 x CO Alarm çıkışı	7760054248	83,00 €	1
------------------	-------------------	---------------------	------------	---------	---

### PicoPac Serisi Pasif İzolasyon Modülleri

PICOPAK-CI-CO-LP-P	1 x 4...20 mA	1 x 4...20 mA	2501110000	125,00 €	1
PICOPAK-CI-CO-LP-S	1 x 4...20 mA	1 x 4...20 mA	2517450000	125,00 €	1

### MCZ Serisi

#### DC/DC Pasif İzolasyon Modülleri, Giriş Döngü Beslemeli

MCZ CCC 0-20mA/0-20mA	1 x 0(4)...20 mA	1 x 0(4)...20 mA	8411190000	150,00 €	10
-----------------------	------------------	------------------	------------	----------	----

#### PT100 Sıcaklık Dönüştürücü Modülleri

MCZ PT100/3 CLP 0...100C	1 x 0...100 °C 2/3 Kablolu	1 x 4...20 mA	8425720000	116,00 €	10
MCZ PT100/3 CLP 0...120C	1 x 0...120 °C 2/3 Kablolu	1 x 4...20 mA	8483680000	120,00 €	10
MCZ PT100/3 CLP 0...150C	1 x 0...150 °C 2/3 Kablolu	1 x 4...20 mA	8604420000	130,00 €	10
MCZ PT100/3 CLP 0...200C	1 x 0...200 °C 2/3 Kablolu	1 x 4...20 mA	8473010000	116,00 €	10
MCZ PT100/3 CLP 0...300C	1 x 0...300 °C 2/3 Kablolu	1 x 4...20 mA	8473020000	116,00 €	10
MCZ PT100/3 CLP -50C...+150C	1 x -50...150 °C 2/3 Kablolu	1 x 4...20 mA	8473000000	116,00 €	10
MCZ PT100/3 CLP -40C...100C	1 x -40...100 °C 2/3 Kablolu	1 x 4...20 mA	8604430000	116,00 €	10

#### Limit Değer İzleme Modülleri

MCZ SC 0-10V	1 x 0...10 V	2 x PNP	8260280000	92,05 €	10
MCZ SC 0-20MA	1 x 0...20 mA	2 x PNP	8227350000	92,05 €	10

Tip	Açıklama	Ürün işlevi	Sipariş No	Fiyat/Birim	Ambalaj
-----	----------	-------------	------------	-------------	---------

### JACKPAC IP68 Sinyal Dönüştürücüler

JPP NPN PNP 24VDC	18...30 V DC / 18...30 V DC	NPN / PNP Dönüştürücü	8852350000	86,95 €	1
JPP PNP NPN 24VDC	18...30 V DC / 18...30 V DC	PNP / NPN Dönüştürücü	8857030000	100,00 €	1
JPR 24VDC 1CO M12	24 V DC ± 20 % / 24 V DC ± 20 %	Röle Modülü	8771420000	76,35 €	1
JPR 24VDC ISO 1CO M12	24 V DC ± 20 % / 24 V	Röle Modülü	8771430000	72,45 €	1
JPOVP RJ45 CAT6 IP20	III	RJ45 Yıldırım Koruma	8805550000	105,00 €	1
JPO 24VDC 0.2A M12S	18...24...30 V DC / 3...33 V DC	Galvanik İzolasyonlu Solid State Röle	2465830000	128,00 €	1
JP TEST	24 V DC ± 25 % / 18...24...30 V DC	Test Adaptörü	8794120000	103,00 €	1
JP CLIP M	-	Montaj Aparatı	8778490000	15,00 €	10

## Enerji Analizörleri

Makine ve tesislerin enerji verimliliklerinin ölçülerek verimliliklerinin artırılması için elektriksel parametrelerin takibi ve izlenmesine ihtiyaç duyulmakta ve enerji yönetim yapıları oluşturulmaktadır.

Weidmüller genişleyen enerji izleme ürün ailesi ile tesislerin ve makinelerin ihtiyaç duyduğu izleme modülleri, enerji verimlilik analizörleri ve yardımcı ekipmanları ile enerji yönetim sistemlerinin tüm ihtiyaçlarına komple çözümler sunmaktadır.

ISO 50001 standartları dâhilinde kurulan enerji yönetim sistemlerinde enerji analizörlerinin önemli bir rolü vardır. Bu ürünlerin hafıza kayıt, ekranda okunan değerlerin gösterilmesi ve güç akış diyagramlarının analizleri konusunda yetkin olmaları gerekmektedir.

Weidmüller'in sunmuş olduğu enerji izleme modülleri ile tüm bu datalar kolaylıkla izlenir, kaydedilir ve analizleri ile sistemlerin enerji verimlilikleri standartlara uygun bir şekilde takip edilebilir.





ENERGY METER 330



ENERGY ANALYSER D550



ENERGY ANALYSER 550

Tip	Açıklama	Sipariş No	Fiyat/Birim	Ambalaj
<b>Ray Tipi Şebeke Analizörleri</b>				
ENERGY METER D650	Akım: 1/5 A, Gerilim L-L: 18...1000 Vrms, Gerilim L-N: 10...600 V AC, Class 0.5s, Tolerans: %0.2, Digital Input: 2, Digital Output: 2, Harmonik: 2. ve 40. distorsiyon arası, Memory: 4 MB, Protokol: Modbus RTU, UL sertifikasyonu	2425490000	1.188,00 €	1
<b>Front Panel Tip Şebeke Analizörleri</b>				
ENERGY METER 330	Akım: 1/5 A, Gerilim L-L: 86 ... 442 Vrms, Gerilim L-N: 50 ...255 V AC, Class 2, Tolerans: %1	2425410000	359,00 €	1
ENERGY METER 350	Akım: 1/5 A, Gerilim L-L: 86 ... 442 Vrms, Gerilim L-N: 50 ... 255 V AC, Class 2, Tolerans: %1, Digital Output: 2	2425420000	463,00 €	1
ENERGY METER 520-230	Akım: 1/5 A, Gerilim L-L: 480V AC, Gerilim L-N: 280V AC, Class 0.5s, Tolerans: %0.2, Digital Input: 2, Digital Output: 2, Harmonik: 2. ve 40. distorsiyon arası, Memory: 4 MB, Protokol: Modbus RTU, UL sertifikasyonu	2500880000	634,00 €	1
ENERGY METER 520-24	Akım: 1/5 A, Gerilim L-L: 480V AC, Gerilim L-N: 280V AC, Class 0.5s, Tolerans: %0.2, Digital Input: 2, Digital Output: 2, Harmonik: 2. ve 40. distorsiyon arası, Memory: 4 MB, Protokol: Modbus RTU, UL sertifikasyonu	2500860000	634,00 €	1
ENERGY METER 700-PN-230	Akım: 1/5 A, Gerilim L-L: 480V AC, Gerilim L-N: 280V AC, Class 0.5s, Tolerans: %0.2, Digital Input: 2, Digital Output: 2, Harmonik: 2. ve 40. distorsiyon arası, Memory: 4 MB, Protokol: PROFINET, Modbus RTU, Modbus TCP/IP, Modbus RTU over Ethernet, SNMP, UL sertifikasyonu	2500890000	1.017,00 €	1
ENERGY METER 700-PN-24	Akım: 1/5 A, Gerilim L-L: 480V AC, Gerilim L-N: 280V AC, Class 0.5s, Tolerans: %0.2, Digital Input: 2, Digital Output: 2, Harmonik: 2. ve 40. distorsiyon arası, Memory: 4 MB, Protokol: PROFINET, Modbus RTU, Modbus TCP/IP, Modbus RTU over Ethernet, SNMP, UL sertifikasyonu	2500870000	1.100,00 €	1
POWER MONITOR	LCD Ekran, Modbus/RTU (RS485), V, I, Var, PF, F, °C	1423550000	417,00 €	1
POWER MONITOR 51A	LCD Ekran, Modbus/RTU (RS485), V, I, Var, PF, F, °C,	1470260000	484,00 €	1
<b>Kalite Analizörleri</b>				
ENERGY ANALYSER D550	Akım: 1/5 A, Gerilim L-L: 18...1000 Vrms, Gerilim L-N: 10...600 V AC, Class 0.5s, Tolerans: V; %0.2, A; %0.2, Harmonik: 2. ve 40. distorsiyon arası, Digital input: 2, Digital output: 2, Memory: 128 MB, Protokol: TCP/IP, DHCP Client (BootP), Modbus/TCP (Port 502), ICMP (Ping), NTP, Modbus RTU over Ethernet (Port 8000), TFTP	2425510000	1.600,00 €	1
ENERGY ANALYSER 550	Akım: 1/5 A, Gerilim L-L: 18...1000 Vrms, Gerilim L-N: 10...600 V AC, Class 0.2s, Tolerans: V; %0.1, A; %0.2, Harmonik: 2. ve 40. distorsiyon arası, Digital input: 8, Digital output: 5, Memory: 256 MB, Protokol: TCP/IP, DHCP Client (BootP), Modbus/TCP (Port 502), ICMP (Ping), NTP, Profibus DP VO, SMTP, TFTP, FTP, SNMP	2425500000	2.751,00 €	1
ENERGY ANALYSER 750-230	Akım: 1/5 A, Gerilim L-L: 600V AC Gerilim L-N: 347V AC, Protokol: Modbus RTU, Modbus-Gateway, Modbus TCP/IP, Modbus RTU over Ethernet, SNMP, Profibus DP VO, BACnet	2534130000	5.000,00 €	1
ENERGY ANALYSER 750-24	Akım: 1/5 A, Gerilim L-L: 600V AC Gerilim L-N: 347V AC, Protokol: Modbus RTU, Modbus-Gateway, Modbus TCP/IP, Modbus RTU over Ethernet, SNMP, Profibus DP VO, BACnet	2534160000	5.000,00 €	1
<b>Enerji Logger</b>				
ENERGY LOGGER D550		2425520000	1.200,00 €	1

## Güç Kaynakları - ConnectPower

Güç kaynakları otomasyon sistemlerinin enerji beslemelerinde kullanılır. Weidmüller güç kaynakları uzun çalışma ömürleri ve verimlilikleri ile rakiplerinden farklılaşmaktadır.

### PROmax / PROeco / PROtop

PROmax / PROeco serisi güç kaynakları stabil şekilde 5, 12, 24, 48 V DC güç değerini garanti eder ve az yer kaplar. 1 ve 3 fazlı olarak seçilebilir. Ray üzerinde aralarında boşluk bırakmadan monte edilebilir. Kritik uygulamalar için yüksek verimliliğe sahiptir. Buna rağmen aşırı yüklenmeye dayanıklı fazla rezervleri vardır. -25°C...+70°C arası geniş çalışma sıcaklığı aralığı hemen her ortamda güvenli kullanımı sağlar. Çok geniş giriş gerilim imkanı ile hem DC hem de AC de çalışabilir.

- 1 fazlı olarak: 3 A, 5 A, 7.5 A, 10 A, 20 A ve 40 A
- 3 fazlı olarak: 5 A, 10 A, 20 A ve 40 A

### Regülesiz Güç Kaynakları

Kompakt yapıda olan bu güç kaynakları dinamik yükler için 36 W...1000W arası güç seçenekleri ile 24 Vdc gerilim sağlar. Giriş ve çıkış arasında izolasyon bir trafo ile sağlanır.

Özellikleri:

- Giriş gerilimi ~230V +/- ~15V veya ~400V +/- ~15V, 50/60 Hz
- Kısa devreye karşı emniyet sistemi
- Anahtar deliği şeklinde montaj yuvası ile zamandan tasarruf
- 144 W'a kadar 35mm DIN rayına monte edilebilir





PRO ECO 72W 24V 3A



PRO ECO3 120W 24V 5A



PRO DM 10



PRO DM 20



PRO MAX 70W 5V 14A



PRO MAX3 120W 24V 5A

Tip	Giriş	Çıkış	Sipariş No	Fiyat/Birim	Ambalaj
<b>PROeco - Anahtarlama</b>					
<b>Tek Fazlı Sistemler</b>					
PRO ECO 72W 24V 3A	85...264 V AC / 80...370 V DC	22...28 V DC 3A	1469470000	80,00 €	1
PRO ECO 120W 24V 5A	85...264 V AC / 80...370 V DC	22...28 V DC 5A	1469480000	105,00 €	1
PRO ECO 240W 24V 10A	85...264 V AC / 80...370 V DC	22...28 V DC 10A	1469490000	185,00 €	1
PRO ECO 480W 24V 20A	85...264 V AC / 80...370 V DC	22...28 V DC 20A	1469510000	260,00 €	1
PRO ECO 960W 24V 40A	85...264 V AC / 80...370 V DC	22...28 V DC 40A	1469520000	520,00 €	1
PRO ECO 72W 12V 6A	85...264 V AC / 80...370 V DC	10...16 V DC 6A	1469570000	90,00 €	1
PRO ECO 120W 12V 10A	85...264 V AC / 80...370 V DC	10...16 V DC 10A	1469580000	139,00 €	1
PRO ECO 240W 48V 5A	85...264 V AC / 80...370 V DC	42...56 V DC 5A	1469590000	160,00 €	1
PRO ECO 480W 48V 10A	85...264 V AC / 80...370 V DC	42...56 V DC 10A	1469610000	260,00 €	1
<b>3 Fazlı Sistemler</b>					
PRO ECO3 120W 24V 5A	3 x 500 V...3 x 400 V AC / 450...800 V DC	22...28 V DC 5A	1469530000	135,00 €	1
PRO ECO3 240W 24V 10A	3 x 500 V...3 x 400 V AC / 450...800 V DC	22...28 V DC 10A	1469540000	200,00 €	1
PRO ECO3 480W 24V 20A	3 x 500 V...3 x 400 V AC / 450...800 V DC	22...28 V DC 20A	1469550000	290,00 €	1
PRO ECO3 960W 24V 40A	3 x 500 V...3 x 400 V AC / 450...800 V DC	22...28 V DC 40A	1469560000	500,00 €	1
<b>Dişot Modülleri</b>					
PRO DM 10	2 x 12 A (-40 °C ~ +45 °C), 2 x 10 A (+45 °C ~ +60 °C)	1 x 24 A (-40 °C ~ +45 °C), 1 x 20 A (+45 °C ~ +60 °C)	2486070000	75,00 €	1
PRO DM 20	2 x 24 A (-40 °C ~ +45 °C), 2 x 20 A (+45 °C ~ +60 °C)	1 x 48 A (-40 °C ~ +45 °C), 1 x 40 A (+45 °C ~ +60 °C)	2486080000	130,00 €	1
CP M DM20	2 X 10 A max veya 1 X 20 A / 24VDC		1222210000	95,65 €	1
CP M DM40	2 x 20 A max veya 1 X 40 A / 24VDC		1222220000	120,00 €	1
<b>PROmax Anahtarlama Güç Kaynakları</b>					
<b>Tek Fazlı Sistemler</b>					
PRO MAX 70W 5V 14A	85...277 V AC / 80...370 V DC	4.5 - 7 V DC / 14 A (Pot)	1478210000	120,00 €	1
PRO MAX 72W 12V 6A	85...277 V AC / 80...370 V DC	10 - 15 V DC / 6 A (Pot)	1478220000	150,00 €	1
PRO MAX 120W 12V 10A	85...277 V AC / 80...370 V DC	10 - 15 V DC / 10 A (Pot)	1478230000	225,00 €	1
PRO MAX 72W 24V 3A	85...277 V AC / 80...370 V DC	22.5 - 29.5 V DC / 3 A (Pot)	1478100000	130,00 €	1
PRO MAX 120W 24V 5A	85...277 V AC / 80...370 V DC	22.5 - 29.5 V DC / 5 A (Pot)	1478110000	160,00 €	1
PRO MAX 180W 24V 7,5A	85...277 V AC / 80...370 V DC	22.5 - 29.5 V DC / 7.5 A (Pot)	1478120000	190,00 €	1
PRO MAX 240W 24V 10A	85...277 V AC / 80...370 V DC	22.5 - 29.5 V DC / 10 A (Pot)	1478130000	270,00 €	1
PRO MAX 480W 24V 20A	85...277 V AC / 80...370 V DC	22.5 - 29.5 V DC / 20 A (Pot)	1478140000	392,00 €	1
PRO MAX 960W 24V 40A	85...277 V AC / 80...370 V DC	22.5 - 29.5 V DC / 40 A (Pot)	1478150000	620,00 €	1
PRO MAX 240W 48V 5A	85...277 V AC / 80...370 V DC	30 - 56 V DC / 5 A (Pot)	1478240000	240,00 €	1
PRO MAX 480W 48V 10A	85...277 V AC / 80...370 V DC	30 - 56 V DC / 10 A (Pot)	1478250000	450,00 €	1
PRO MAX 960W 48V 20A	85...277 V AC / 80...370 V DC	30 - 56 V DC / 20 A (Pot)	1478270000	700,00 €	1
<b>Üç Fazlı Sistemler</b>					
PRO MAX3 120W 24V 5A	320-575 VAC/450-800VDC	22.5 - 29.5 V DC / 5 A (Pot)	1478170000	260,00 €	1

Serinin devamı sayfa 123



PRO TOP1 72W 24V 3A

Tip	Giriş	Çıkış	Sipariş No	Fiyat/Birim	Ambalaj
PRO MAX3 240W 24V 10A	320-575 VAC/450-800VDC	22.5 - 29.5 V DC / 10 A (Pot)	1478180000	310,00 €	1
PRO MAX3 480W 24V 20A	320-575 VAC/450-800VDC	22.5 - 29.5 V DC / 20 A (Pot)	1478190000	420,00 €	1
PRO MAX3 960W 24V 40A	320-575 VAC/450-800VDC	22.5 - 29.5 V DC / 40 A (Pot)	1478200000	675,00 €	1

**Kapasite Modülü**

CP M CAP	18...30 Vdc	1222240000	63,50 €	1
----------	-------------	------------	---------	---

**PROtop - Dynamic Current Limiting - Single/Paralel Mode - EX Alan İçin**

PRO TOP1 72W 24V 3A	85...277 V AC / 80 ... 410 V DC	22.5...29 V DC	2466850000	150,00 €	1
PRO TOP1 120W 24V 5A	85...277 V AC / 80 ... 410 V DC	22.5...29 V DC	2466870000	190,00 €	1
PRO TOP1 120W 24V 5A EX	85...277 V AC / 80 ... 410 V DC	22.5...29 V DC	2466980000	200,00 €	1
PRO TOP1 240W 24V 10A	85...277 V AC / 80 ... 410 V DC	22.5...29 V DC	2466880000	270,00 €	1
PRO TOP1 240W 24V 10A EX	85...277 V AC / 80 ... 410 V DC	22.5...29 V DC	2466990000	300,00 €	1
PRO TOP1 480W 24V 20A	85...277 V AC / 80 ... 410 V DC	22.5...29 V DC	2466890000	380,00 €	1
PRO TOP1 480W 24V 20A EX	85...277 V AC / 80 ... 410 V DC	22.5...29 V DC	2467000000	500,00 €	1
PRO TOP1 960W 24V 40A	85...277 V AC / 80 ... 410 V DC	22.5...29 V DC	2466900000	800,00 €	1
PRO TOP1 960W 24V 40A EX	85...277 V AC / 80 ... 410 V DC	22.5...29 V DC	2467010000	850,00 €	1
PRO TOP1 480W 48V 10A	85...277 V AC / 80 ... 410 V DC	45...56 V DC	2467030000	462,00 €	1
PRO TOP1 960W 48V 20A	85...277 V AC / 80 ... 410 V DC	45...56 V DC	2466920000	820,00 €	1
PRO TOP1 120W 12V 10A	85...277 V AC / 80 ... 410 V DC	11...15 V DC	2466910000	225,00 €	1

**Not:** Diğer EX-PROOF ürünler için bizimle iletişime geçebilirsiniz.

Tip	Açıklama	Sipariş No	Fiyat/Birim	Ambalaj
-----	----------	------------	-------------	---------

**PROtop - Dynamic Current Limiting - Single/Paralel Mode - EX Alan İçin****PROtop Haberleşme Modülü**

PRO COM CAN OPEN	PROTOP CANopen Haberleşme Modülü	2467320000	65,00 €	1
PRO COM IO-LINK	PROTOP IO-LINK Haberleşme Modülü	2587360000	84,00 €	1

**PROtop Haberleşme Kablosu**

PRO CAB SUBD-RJ45 0.5M	0.5 m (9 pin sub-D konnektör / IP 20 RJ45)	2578530000	30,00 €	1
PRO CAB SUBD-RJ45 1.0M	1 m (9 pin sub-D konnektör / IP 20 RJ45)	2578550000	27,00 €	1
PRO CAB SUBD-RJ45 2.5M	2.5 m (9 pin sub-D konnektör / IP 20 RJ45)	2578560000	36,00 €	1

Tip	Giriş	Çıkış	Sipariş No	Fiyat/Birim	Ambalaj
-----	-------	-------	------------	-------------	---------

**INSTAPOWER - Anahtarlamalı**

PRO INSTA 30W 5V 6A	85 - 264 V AC	5 V DC / 6 A	2580210000	50,00 €	1
PRO INSTA 30W 12V 2.6A	85 - 264 V AC	12 V DC / 2.6 A	2580220000	48,00 €	1
PRO INSTA 60W 12V 5A	85 - 264 V AC	12 V DC / 5 A	2580240000	60,00 €	1
PRO INSTA 16W 24V 0.7A	85 - 264 V AC	24 V DC / 0.7 A	2580180000	32,00 €	1
PRO INSTA 30W 24V 1.3A	85 - 264 V AC	24 V DC / 1.3 A	2580190000	48,00 €	1
PRO INSTA 60W 24V 2.5A	85 - 264 V AC	24 V DC / 2.5 A	2580230000	60,00 €	1
PRO INSTA 96W 24V 4A	85 - 264 V AC	24 V DC / 3.8 A	2580260000	75,00 €	1
PRO INSTA 90W 24V 3.8A	85 - 264 V AC	24 V DC / 4 A	2580250000	75,00 €	1
PRO INSTA 96W 48V 2A	85 - 264 V AC	48 V DC / 2 A	2580270000	75,00 €	1

Tip	Giriş	Sipariş No	Fiyat/Birim	Ambalaj
-----	-------	------------	-------------	---------

**UPS Kontrol - Batarya - Buffer modülleri**

CP DC UPS 24V 20A/10A	UPS Kontrol modülü 24 Vdc, 20 A / 10 A	1370050010	296,00 €	1
CP DC UPS 24V 40A	UPS Kontrol modülü 24 Vdc, 40A	1370040010	488,00 €	1
CP A BATTERY 24V DC1.3AH	Batarya 3min @ 10A	1406930000	240,00 €	1
CP A BATTERY 24V DC3.4AH	Batarya 11,3 min @ 10 A / 5 min @ 20 A	1251070000	200,00 €	1
CP A BATTERY 24V DC7.2AH	Batarya 26,5 min @ 10 A / 11,5 min @ 20 A / 5 min @ 30 A	1251080000	240,00 €	1
CP A BATTERY 24V DC12AH	Batarya 51 min @ 10 A / 22,7 min @ 20 A / 9,2 min @ 30 A	1251090000	400,00 €	1



PRO TOP1 120W 24V 5A EX



PRO TOP1 480W 24V 20A EX



PRO TOP1 960W 24V 40A EX



CP DC UPS 24V 20A/10A



CP A BATTERY 24V DC3.4AH

Serinin devamı sayfa 124



PRO DCDC 120W 24V 5A



FreeCon



TGD FIM-C



TGD ELM-12



TGD ELM-6



maxGUARD



AMG FIM-0

Tip	Giriş	Sipariş No	Fiyat/Birim	Ambalaj
CP A BATTERY 24V DC17AH	Batarya 81 min @ 10 A / 34,2 min @ 20 A / 13,5 min @ 30 A	1251110000	460,00 €	1
CP DC BUFFER 24V 20A	Buffer modülü 24 Vdc, 20 A,	1251220000	292,00 €	1

Tip	Giriş	Çıkış	Sipariş No	Fiyat/Birim	Ambalaj
<b>DC/DC Dönüştürücü</b>					
PRO DCDC 120W 24V 5A	24 V DC	22.5...29.5 V DC 5A	2001800000	155,00 €	1
PRO DCDC 240W 24V 10A	24 V DC	22.5...29.5 V DC 10A	2001810000	260,00 €	1
PRO DCDC 480W 24V 20A	24 V DC	22.5...29.5 V DC 20A	2001820000	330,00 €	1
DCDC 24V-120V 230W	24 V DC	96 V DC / 144 V DC, 2A	1507190000	860,00 €	1

Tip	Giriş	Çıkış	Sipariş No	Fiyat/Birim	Ambalaj
<b>PROTOP DC/DC Dönüştürücü</b>					
* PRO TOPDC 24V/24V 5A	14 V...31.2 V DC	22.5...28.8 V DC / 5A	2627650000	360,00 €	1
* PRO TOPDC 24V/24V 10A	15 V...31.2 V DC	22.5...28.8 V DC / 5A	2627640000	480,00 €	1
* PRO TOPDC 24V/24V 20A	16 V...31.2 V DC	22.5...28.8 V DC / 5A	2627630000	740,00 €	1
* PRO TOPDC 24V/24V 5A EX	17 V...31.2 V DC	22.5...28.8 V DC / 5A	2467290000	390,00 €	1
* PRO TOPDC 24V/24V 10A EX	18 V...31.2 V DC	22.5...28.8 V DC / 5A	2467300000	530,00 €	1
* PRO TOPDC 24V/24V 20A EX	19 V...31.2 V DC	22.5...28.8 V DC / 5A	2467310000	780,00 €	1
* PRO TOPDC 24V/48V 10A	20 V...31.2 V DC	45...56 V DC / 10A	2627660000	740,00 €	1

Tip	Açıklama	Sipariş No	Fiyat/Birim	Ambalaj
<b>Redundancy Modülleri</b>				
PRO RM 10 10 ... 32 V DC	2 × 10 A Eşit Yük Paylaşımı için Redundancy Modülü	2486090000	135,00 €	1
PRO RM 20 10 ... 32 V DC	2 × 20 A Eşit Yük Paylaşımı için Redundancy Modülü	2486100000	180,00 €	1
PRO RM 40 10 ... 32 V DC	2 × 40 A Eşit Yük Paylaşımı için Redundancy Modülü	2486110000	205,00 €	1

Tip	Giriş	Sipariş No	Fiyat/Birim	Ambalaj
<b>FreeCon Wireless Enerji Aktarım Modülü</b>				
IE-CL240W-PP-BASE	Primary Side 24V DC	1547440000	1.200,00 €	1
IE-CL240W-PP-REMOTE	Secondary side 10A-0.5mm	1547450000	1.000,00 €	1
IE-CL-MOUNT-CLIP	Clip Aparatı	1994360000	Sorunuz	1
IE-CL-MOUNT-PROFILE	Montaj Profili	1994370000	Sorunuz	1

Tip	Açıklama	Sipariş No	Fiyat/Birim	Ambalaj
<b>topGUARD Elektronik Sigorta Modülleri</b>				
TGD FIM-C	IO-LINK Eklenebilir Besleme Modülü	2625000000	105,00 €	1
TGD ELM-12	4-12A Ayarlanabilir Sigorta Modülü	2624990000	74,00 €	1
TGD ELM-4 CL2	4A Sigorta Modülü	2656670000	68,00 €	1
TGD ELM-6	1-6A Ayarlanabilir Sigorta Modülü	2624980000	70,00 €	1
PRO COM IO-LINK	IO-LINK Haberleşme Modülü	2587360000	84,00 €	1

Tip	Açıklama	Sipariş No	Fiyat/Birim	Ambalaj
<b>maxGUARD Elektronik Sigorta Modülleri</b>				
<b>maxGUARD Besleme Modülleri</b>				
AMG FIM-0	18 ... 31.2 V DC, 40A Pasif Dağıtım Bloğu	2081870000	7,15 €	1
AMG FIM-C	18 ... 31.2 V DC, 40A Dağıtım Bloğu, Alarm ve Reset Fonksiyonlu	2081880000	35,00 €	1
AMG FIM-0 Ex	18 ... 31.2 V DC, 40A Pasif Dağıtım Bloğu Ex	2082530000	9,00 €	1
AMG FIM-C Ex	18 ... 31.2 V DC, 40A Dağıtım Bloğu, Alarm ve Reset Fonksiyonlu Ex	2082540000	40,00 €	1

Tip	Açıklama	Sipariş No	Fiyat/Birim	Ambalaj
<b>maxGUARD Elektronik Sigorta Modülleri</b>				
AMG ELM-1F	1A Sabit Değer	2080420000	35,00 €	1
AMG ELM-2F	2A Sabit Değer	2080480000	35,00 €	1
AMG ELM-4F	4A Sabit Değer	2080490000	35,00 €	1
AMG ELM-6F	6A Sabit Değer	2080500000	35,00 €	1
AMG ELM-8F	8A Sabit Değer	2080600000	38,00 €	1
AMG ELM-10F	10A Sabit Değer	2080650000	38,00 €	1
AMG ELM-Q2222	4 Kanal 2A sabit	2080750000	113,00 €	1
AMG ELM-Q2244	4 Kanal 2 x 2A, 2 x 4A	2081650000	113,00 €	1

Tip	Açıklama	Sipariş No	Fiyat/Birim	Ambalaj
AMG ELM-Q2266	4 Kanal 2 x 2A, 2 x 6A	2081820000	125,00 €	1
AMG ELM-Q4444	4 Kanal 4 x 4A	2080880000	120,00 €	1
AMG ELM-Q6666	4 Kanal 4 x 6A	2080920000	125,00 €	1
AMG ELM-1F CL2	1A Sabit Değer, Class 2 aproved	2491270000	37,15 €	1
AMG ELM-2F CL2	2A Sabit Değer, Class 2 aproved	2491280000	37,15 €	1
AMG ELM-4F CL2	4A Sabit Değer, Class 2 aproved	2491290000	38,50 €	1
AMG ELM-6	6A'e Kadar Ayarlanabilir	2080360000	42,50 €	1
AMG ELM-12	12A'e Kadar Ayarlanabilir	2080410000	48,00 €	1
AMG ELM-1F EX	1A Sabit Değer Ex	2082040000	37,50 €	1
AMG ELM-2F EX	2A Sabit Değer Ex	2082050000	37,50 €	1
AMG ELM-4F EX	4A Sabit Değer Ex	2082060000	45,00 €	1
AMG ELM-6F EX	6A Sabit Değer Ex	2082310000	48,00 €	1
AMG ELM-8F EX	8A Sabit Değer Ex	2082320000	52,00 €	1
AMG ELM-10F EX	10A Sabit Değer Ex	2082430000	42,50 €	1
AMG ELM-6 EX	6A'e Kadar Ayarlanabilir Ex	2082000000	55,00 €	1
AMG ELM-12 EX	12A'e Kadar Ayarlanabilir Ex	2082010000	60,00 €	1
<b>maxGUARD Elektronik Yük İzleme</b>				
AMG ELM-6D CO	6A röle çıkışlı	2082440000	59,50 €	1
AMG ELM-10D CO	10A röle çıkışlı	2082470000	65,00 €	1
<b>maxGUARD Potansiyel Dağıtım Klemensleri</b>				
AMG DIS	Ölçme Ayırma Klemensi	2123050000	4,95 €	10
AMG MD	4 x Negatif	2122930000	3,00 €	10
AMG OD	2 x Pozitif, 2 x Negatif	2122910000	3,00 €	10
AMG PD	4 x Pozitif	2122920000	3,00 €	10
AMG OD EX	2 x Pozitif, 2 x Negatif Ex	2495090000	4,00 €	10
AMG PD EX	4 x Pozitif Ex	2495070000	4,00 €	10
AMG MD EX	4 x Negatif Ex	2495040000	4,00 €	10
AMG XMD EX	4 x Negatif Ex	2495080000	3,50 €	10
AMG DIS EX	Ölçme Ayırma Klemensi Ex	2495100000	6,00 €	10
<b>maxGUARD Alarm Modülü</b>				
AMG AM	(2 x NO)	2081890000	38,00 €	1
AMG AM CO	(2 x NO) Ex	2082770000	38,00 €	1
<b>maxGUARD Kontrol Modülü</b>				
AMG CM	Operasyon duruş ve erken uyarı modülü	2081900000	35,00 €	1
AMG CM EX	Operasyon duruş ve erken uyarı modülü Ex	2083360000	35,00 €	1
<b>maxGUARD Aksesuarları</b>				
AMG PP	Ayırma Plakası	2123000000	1,35 €	40
AMG EP	Sonlandırma Plakası	2495380000	3,00 €	30
<b>Turuncu Tarak Köprü</b>				
ZQV 4N/2	2 pole	1527930000	5,58 TL	60
ZQV 4N/3	3 pole	1527940000	10,20 TL	60
ZQV 4N/4	4 pole	1527970000	15,25 TL	60
ZQV 4N/5	5 pole	1527980000	20,05 TL	60
ZQV 4N/6	6 pole	1527990000	24,90 TL	20
ZQV 4N/7	7 pole	1528020000	29,60 TL	20
ZQV 4N/8	8 pole	1528030000	34,55 TL	20
ZQV 4N/9	9 pole	1528070000	39,10 TL	20
ZQV 4N/10	10 pole	1528090000	44,95 TL	20
ZQV 4N/50	50 pole	1528130000	256,60 TL	5



AMG ELM-6D CO



AMG OD



AMG AM



ZQV 4N/4





ZQV 4N/4 BL



ZQV 4N/4



PRO PM 35W 5V 7A



PRO PM 75W 12V 6A



PRO PM 100W 12V 8.5A



PRO PM 150W 24V 6.5A



PRO PM 250W 12V 21A



PRO PM 350W 48V 7.3A

Tip	Açıklama	Sipariş No	Fiyat/Birim	Ambalaj
<b>Mavi Tarak Köprü</b>				
ZQV 4N/2 BL	2 pole	1528040000	5,51 TL	60
ZQV 4N/3 BL	3 pole	1528080000	9,95 TL	60
ZQV 4N/4 BL	4 pole	1528120000	14,85 TL	60
ZQV 4N/5 BL	5 pole	1528140000	19,50 TL	60
ZQV 4N/6 BL	6 pole	1528170000	24,30 TL	20
ZQV 4N/7 BL	7 pole	1528180000	28,85 TL	20
ZQV 4N/8 BL	8 pole	1528190000	33,65 TL	20
ZQV 4N/9 BL	9 pole	1528220000	38,25 TL	20
ZQV 4N/10 BL	10 pole	1528230000	43,80 TL	20
ZQV 4N/50 BL	50 pole	1528240000	250,00 TL	5

Tip	Açıklama	Sipariş No	Fiyat/Birim	Ambalaj
<b>Kırmızı Tarak Köprü</b>				
ZQV 4N/2	2 pole	2460450000	5,51 TL	60
ZQV 4N/3	3 pole	2460810000	9,95 TL	60
ZQV 4N/4	4 pole	2460800000	14,85 TL	60
ZQV 4N/5	5 pole	2460790000	19,50 TL	60
ZQV 4N/6	6 pole	2460780000	24,30 TL	20
ZQV 4N/7	7 pole	2460770000	28,85 TL	20
ZQV 4N/8	8 pole	2460760000	33,65 TL	20
ZQV 4N/9	9 pole	2460750000	38,25 TL	20
ZQV 4N/10	10 pole	2460740000	43,80 TL	20
ZQV 4N/50	50 pole	2460730000	250,00 TL	5

Tip	Giriş	Çıkış	Sipariş No	Fiyat/Birim	Ambalaj
<b>PRO PM</b>					
<b>Tek Faz 35W Sistemler</b>					
* PRO PM 35W 5V 7A	90~264V AC	5V DC / /7A	2660200277	25,50 €	1
* PRO PM 35W 12V 3A	90~264V AC	12V DC / /3A	2660200278	24,15 €	1
* PRO PM 35W 24V 1.5A	90~264V AC	24V DC / 1.5A	2660200279	23,85 €	1
* PRO PM 35W 48V 0.75A	90~264V AC	48V DC / 0.75A	2660200280	24,05 €	1
<b>Tek Faz 75W Sistemler</b>					
* PRO PM 75W 5V 14A	90~264V AC	5V DC / 14A	2660200281	30,95 €	1
* PRO PM 75W 12V 6A	90~264V AC	12V DC / 6A	2660200282	28,50 €	1
* PRO PM 75W 24V 3.2A	90~264V AC	24V DC / 3.2A	2660200283	27,85 €	1
* PRO PM 75W 48V 1.6A	90~264V AC	48V DC / 1.6A	2660200284	28,20 €	1
<b>Tek Faz 100W Sistemler</b>					
* PRO PM 100W 12V 8.5A	90~264V AC	12V DC / 8.5A	2660200285	32,75 €	1
* PRO PM 100W 24V 4.5A	90~264V AC	24V DC / 4.5A	2660200286	32,65 €	1
* PRO PM 100W 48V 2.3A	90~264V AC	48V DC / 2.3A	2660200287	32,70 €	1
<b>Tek Faz 150W Sistemler</b>					
* PRO PM 150W 12V 12.5A	90~132 / 180~264V AC (Switch ile)	12V DC / 12.5A	2660200288	40,90 €	1
* PRO PM 150W 24V 6.5A	90~132 / 180~264V AC (Switch ile)	24V DC / 6.5A	2660200289	39,65 €	1
* PRO PM 150W 48V 3.3A	90~132 / 180~264V AC (Switch ile)	48V DC / 3.3A	2660200290	40,75 €	1
<b>Tek Faz 250W Sistemler</b>					
* PRO PM 250W 12V 21A	90~264V AC	12V DC / 21A	2660200291	71,00 €	1
* PRO PM 250W 24V 10.5A	90~264V AC	24V DC / 10.5A	2660200292	67,65 €	1
* PRO PM 250W 48V 5.2A	90~264V AC	48V DC / 5.2A	2660200293	70,85 €	1
<b>Tek Faz 350W Sistemler</b>					
* PRO PM 350W 24V 14.6A	90~264V AC	24V DC / 14.6A	2660200294	75,60 €	1
* PRO PM 350W 48V 7.3A	90~264V AC	48V DC / 7.3A	2660200295	78,30 €	1

## Aşırı Gerilim Koruma Modülleri

Weidmüller aşırı gerilim koruma modülleri normal değerleri aşan gerilim piklerini sınır noktasına ulaşmadan çalışma gerilimine indirir. İzolasyon koordinasyonu DIN VDE 0110 standartlarında belirtilen değerlerden daha iyi değerlere sahiptir. İyi bir aşırı gerilim koruma modülü şu kriterlerden belli olur:

- Hızlı reaksiyon
- Yıldırım akımı taşıma kapasitesi
- Çok az artık gerilim

Weidmüller bu kriterleri tamamıyla karşılayan ürünler imal eder. Ürünler, kullanılacak yere göre tek bir komponent, ya da bu komponentlerin kombinasyonlarından oluşur.

### Aşırı gerilim koruma sınıfı Tip 1

Ana trafolarla tesis edilir. Yıldırım düştüğü zaman kendilerinden sonra gelen ekipmanları korur.

### Aşırı gerilim koruma sınıfı Tip 2

Kullanım yeri alt dağıtım panelleridir. Uzak yıldırım etkilerine ve şebekeden gelen piklere karşı etkilidir.

### Aşırı gerilim koruma sınıfı Tip 3

Son cihazların korunması için kullanılır. Koruma seviyeleri daha hassastır.

Tamamıyla bir koruma sağlamak için bütün riskleri göz önünde bulundurmak gerekir. En son cihaza yapılan koruma hiçbir zaman yakın yıldırıma karşı koruma sağlamaz

## Aşırı Gerilim Koruma Modüllerinin Ölçü Kontrol Devrelerinde Kullanımı (MSR)

Weidmüller ölçü kontrol devreleri için koruma modüllerini ilk olarak 20 yıl önce üretti. Değişik gerilim aşma komponentleri kullanılarak sürekli geliştirilen ürünler sayesinde Weidmüller çok kapsamlı çözümler sunmaktadır. Ürün portföyünde klemenslere entegre edilmiş, vidalı, yaylı veya push in bağlantı teknolojilerine sahip çok sayıda alternatifler bulunmaktadır.

Uygulamalar:

- 0 (4)-20 mA Analog sinyaller
- 0-10V Analog sinyaller
- Digital sinyaller
- Analog şalt sinyaller



## Aşırı Gerilim Koruma Modülleri



VPU I 3 LCF 280V/25KA



VPU AC II 1 300/50



VPU AC II 3+1 300/50



VPU III R 230V/6KV AC



VPU III SO LD+A



BNC Connector / M-F



VARIRECTOR LOGGER 30

Tip	Açıklama	Sipariş No	Fiyat/Birim	Ambalaj
<b>Class I+II (B+C)</b>				
VPU I 1 R LCF 280V/25KA	8/20 µs deşarj akım:25kA, 1 faz	1351570000	195,00 €	1
VPU I 1+1 R LCF 280V/25KA	8/20 µs deşarj akım:25kA, 1 faz+ 1 Nötr	1351740000	347,00 €	1
VPU I 3 R LCF 280V/25KA	8/20 µs deşarj akım:25kA, 3 faz	1351670000	558,00 €	1
VPU I 3+1 R LCF 280V/25KA	8/20 µs deşarj akım:25kA, 3 faz+1 Nötr	1351770000	737,00 €	1
VPU I 1 LCF 280V/35KA	10/350 µs deşarj akım:35kA	1351350000	259,00 €	1
VPU I 1 N-PE 260V/100KA	N-PE,8/20µs deşarj akım:100kA	1351920000	180,00 €	1
VPU I 3 LCF 280V/25KA	8/20 µs deşarj akım:25kA, 3 faz,Tip I+II/Röle çıkışı yok	1351690000	650,00 €	1
VPU I 3+1 LCF 280V/25KA	8/20 µs deşarj akım:25kA, 3 faz+ 1 Nötr,Tip I+II/Röle çıkışı yok	1351780000	702,00 €	1
VPU I 1 R 280V/12,5KA	10/350 µs deşarj akım:12,5kA, 1 faz,Tip I+II, Röle Çıkışlı	1352140000	80,00 €	1
VPU I 2 R 280V/12,5KA	10/350 µs deşarj akım:12,5kA, 2 faz,Tip I+II, Röle Çıkışlı	1352170000	150,00 €	1
VPU I 3 R 280V/12,5KA	10/350 µs deşarj akım:12,5kA, 3 faz,Tip I+II, Röle Çıkışlı	1352220000	250,00 €	1
VPU I 4 R 280V/12,5KA	10/350 µs deşarj akım:12,5kA, 4 faz,Tip I+II, Röle Çıkışlı	1352190000	289,00 €	1
VPU I 1 280V/12,5KA	10/350 µs deşarj akım:12,5kA, 1 faz,Tip I+II, Röle Çıkışı yok	1352130000	85,00 €	1
VPU I 2 280V/12,5KA	10/350 µs deşarj akım:12,5kA, 2 faz,Tip I+II, Röle Çıkışı yok	1352150000	133,00 €	1
VPU I 3 280V/12,5KA	10/350 µs deşarj akım:12,5kA, 3 faz,Tip I+II, Röle Çıkışı yok	1352200000	193,00 €	1
VPU I 4 280V/12,5KA	10/350 µs deşarj akım:12,5kA, 4 faz,Tip I+II, Röle Çıkışı yok	1352180000	257,00 €	1
VPU I 3+1 280V/12,5KA	10/350 µs deşarj akım:12,5kA, 3 faz+ 1 Nötr,Tip I+II, Röle Çıkışı yok	1352230000	364,00 €	1
VPU I 3+1 R 280V/12,5KA	10/350 µs deşarj akım:12,5kA, 3 faz+ 1 Nötr,Tip I+II, Röle Çıkışlı	1352240000	396,00 €	1
<b>Class II (C Sınıfı)</b>				
VPU AC II 1 R 300/50	8/20 µs deşarj akım:20kA, 1 faz, Tip II, Röle çıkışlı	2591030000	46,00 €	1
VPU AC II 2 R 300/50	8/20 µs deşarj akım:20kA, 2 faz, Tip II, Röle çıkışlı	2591050000	80,00 €	1
VPU AC II 3 R 300/50	8/20 µs deşarj akım:20kA, 3 faz, Tip II, Röle çıkışlı	2591170000	130,00 €	1
VPU AC II 4 R 300/50	8/20 µs deşarj akım:20kA, 4 faz, Tip II, Röle çıkışlı	2591150000	140,00 €	1
VPU AC II 1 300/50	8/20 µs deşarj akım:20kA, 1 faz, Tip II, Röle çıkışı yok	2591020000	32,00 €	1
VPU AC II 2 300/50	8/20 µs deşarj akım:20kA, 2 faz, Tip II, Röle çıkışı yok	2591040000	72,00 €	1
VPU AC II 3 300/50	8/20 µs deşarj akım:20kA, 3 faz, Tip II, Röle çıkışı yok	2591160000	110,00 €	1
VPU AC II 4 300/50	8/20 µs deşarj akım:20kA, 4 faz, Tip II, Röle çıkışı yok	2591140000	122,00 €	1
<b>Class II (C Sınıfı) TN ve TT sistem</b>				
VPU AC II 1+1 R 300/50	8/20 µs deşarj akım:20kA, 1 faz + 1 Nötr, Tip II, Röle çıkışlı	2591070000	84,00 €	1
VPU AC II 3+1 R 300/50	8/20 µs deşarj akım:20kA, 3 faz + 1 Nötr, Tip II, Röle çıkışlı	2591090000	150,00 €	1
VPU AC II 1+1 300/50	8/20 µs deşarj akım:20kA, 1 faz + 1 Nötr, Tip II, Röle çıkışı yok	2591060000	72,00 €	1
VPU AC II 3+1 300/50	8/20 µs deşarj akım:20kA, 3 faz + 1 Nötr, Tip II, Röle çıkışı yok	2591080000	119,00 €	1
<b>Class III (D Sınıfı)</b>				
VPU III R 230V/6KV AC	8/20 µs deşarj akım:3kA,230VAC, Tip III	1351650000	80,00 €	1
VPU III R 120V/6KV AC/DC	8/20 µs deşarj akım:3kA,120VAC/DC, Tip III	1351630000	69,50 €	1
VPU III R 48V/4KV AC/DC	8/20 µs deşarj akım:2kA,48VAC/DC, Tip III	1351600000	69,50 €	1
VPU III R 24V/4KV AC/DC	8/20 µs deşarj akım:2kA,24VAC/DC, Tip III	1351580000	75,00 €	1
VPU III R 12V/4KV AC/DC	8/20 µs deşarj akım:2kA,12VAC/DC, Tip III	1351550000	69,50 €	1
<b>Class III (D Sınıfı) Seyyar Tip</b>				
VPU III SO LD+A	Tip III priz koruma, akustik alarm	1351700000	53,50 €	1
VPU III SO LD	Tip III priz koruma	1351680000	53,50 €	1
<b>Koaksiyel Kablolar İçin Yıldırım Korumalar</b>				
BNC Connector / M-F	Video, 8/20 µs deşarj akım:20kA	8947820000	100,00 €	1
N Connector / M-F	GSM, 8/20 µs deşarj akım:20kA	8947830000	149,00 €	1
F Connector / M-F	SAT, 8/20 µs deşarj akım:20kA	8947840000	135,00 €	1
UHF Connector / M-F	Analog, 8/20 µs deşarj akım:20kA	8947850000	76,40 €	1
<b>Aşırı Gerilim İzleme Modülü</b>				
VARIRECTOR LOGGER 30	LCD, max. puls sayısı: 80, 8/20 µs max. deşarj akım dayanımı 40kA	1428780000	514,00 €	1



VSPC 1CL 24VDC R

Tip	Açıklama	Sipariş No	Fiyat/Birim	Ambalaj
<b>Analog Sinyal İçin Ani Aşırı Gerilim Korumalar</b>				
VSPC 1CL 5VDC R	20 kA, 1 Kanal, Alarm	8951530000	140,00 €	1
VSPC 1CL 12VDC R	20 kA, 1 Kanal, Alarm	8951540000	140,00 €	1
VSPC 1CL 24VDC R	20 kA, 1 Kanal, Alarm	8951550000	140,00 €	1
VSPC 1CL 24VAC R	20 kA, 1 Kanal, Alarm	8951560000	140,00 €	1
VSPC 2CL 5VDC R	20 kA, 2 Kanal, Alarm	8951460000	193,00 €	1
VSPC 2CL 12VDC R	20 kA, 2 Kanal, Alarm	8951470000	193,00 €	1
VSPC 2CL 24VDC R	20 kA, 2 Kanal, Alarm	8951480000	193,00 €	1
VSPC 1CL 5VDC	20 kA, 1 Kanal	8924420000	91,00 €	1
VSPC 1CL 12VDC	20 kA, 1 Kanal	8924450000	91,00 €	1
VSPC 1CL 24VDC	20 kA, 1 Kanal	8924480000	91,00 €	1
VSPC 1CL 24VAC	20 kA, 1 Kanal	8924500000	91,00 €	1
VSPC 1CL 48VAC	20 kA, 1 Kanal	8924520000	91,00 €	1
VSPC 1CL 60VAC	20 kA, 1 Kanal	8924530000	91,00 €	1
VSPC 2CL 5VDC	20 kA, 2 Kanal	8924400000	172,00 €	1
VSPC 2CL 12VDC	20 kA, 2 Kanal	8924440000	172,00 €	1
VSPC 2CL 24VDC	20 kA, 2 Kanal	8924470000	172,00 €	1
VSPC 2CL 24VAC	20 kA, 2 Kanal	8924490000	172,00 €	1
VSPC 2CL 48VAC	20 kA, 2 Kanal	8951490000	172,00 €	1
VSPC BASE 1CL R	1 Kanal, Alarm, Doğrudan Topraklama	8951730000	42,90 €	1
VSPC BASE 1CL FG R	1 Kanal, Alarm Dolaylı Topraklama	8951740000	42,90 €	1
VSPC BASE 1CL	1 Kanal, Doğrudan Topraklama	8924730000	32,00 €	1
VSPC BASE 1CL FG	1 Kanal, Spark Gap ile Doğrudan	8924290000	37,50 €	1
VSPC BASE 2CL R	2 Kanal, Alarm, Doğrudan Topraklama	8951710000	64,25 €	1
VSPC BASE 2CL FG R	2 Kanal, Alarm Dolaylı Topraklama	8951720000	72,90 €	1
VSPC BASE 2CL	2 Kanal, Doğrudan Topraklama	8924710000	54,50 €	1
VSPC BASE 2CL FG	2 Kanal Spark Gap ile Doğrudan	8924270000	58,90 €	1
<b>Dijital Sinyal İçin Ani Aşırı Gerilim Korumalar</b>				
VSPC 2SL 5VDC R	20 kA, 2 Kanal, Alarm / 5 V DC / 300 mA	8951610000	140,00 €	1
VSPC 2SL 12VDC R	20 kA, 2 Kanal, Alarm / 12 V DC / 300 mA	8951620000	140,00 €	1
VSPC 2SL 24VDC R	20 kA, 2 Kanal, Alarm / 24 V DC / 300 mA	8951630000	140,00 €	1
VSPC 2SL 24VAC R	20 kA, 2 Kanal, Alarm / 24 V AC / 300 mA	8951640000	140,00 €	1
VSPC 4SL 5VDC R	20 kA, 4 Kanal, Alarm / 5 V DC / 350 mA	8951570000	230,00 €	1
VSPC 4SL 12VDC R	20 kA, 4 Kanal, Alarm / 12 V DC / 300 mA	8951580000	230,00 €	1
VSPC 4SL 24VDC R	20 kA, 4 Kanal, Alarm / 24 V DC / 300 mA	8951590000	230,00 €	1
VSPC 4SL 24VAC R	20 kA, 4 Kanal, Alarm / 24 V AC / 300 mA	8951600000	230,00 €	1
VSPC 2SL 5VDC	20 kA, 2 Kanal / 5 V DC / 300 mA	8924210000	99,60 €	1
VSPC 2SL 12VDC	20 kA, 2 Kanal / 12 V DC / 300 mA	8924230000	99,60 €	1
VSPC 2SL 24VDC	20 kA, 2 Kanal / 24 V DC / 300 mA	8924330000	99,60 €	1
VSPC 2SL 24VAC	20 kA, 2 Kanal / 24 V AC / 300 mA	8924350000	99,60 €	1
VSPC 2SL 48VAC	20 kA, 2 Kanal / 48 V AC / 250 mA	8924370000	99,60 €	1
VSPC 4SL 5VDC	20 kA, 4 Kanal / 5 V DC / 350 mA	8924200000	193,00 €	1
VSPC 4SL 12VDC	20 kA, 4 Kanal / 12 V DC / 300 mA	8924220000	193,00 €	1
VSPC 4SL 24VDC	20 kA, 4 Kanal / 24 V DC / 300 mA	8924320000	193,00 €	1
VSPC 4SL 24VAC	20 kA, 4 Kanal / 24 V AC / 300 mA	8924340000	193,00 €	1
VSPC 4SL 48VAC	20 kA, 4 Kanal / 48 V AC / 250 mA	8924360000	193,00 €	1
VSPC 4SL 60VAC	20 kA, 4 Kanal / 60 V AC / 200 mA	8924380000	193,00 €	1
VSPC BASE 2SL R	2 Kanal, Alarm, Doğrudan Topraklama, Taban	8951770000	42,80 €	1
VSPC BASE 2SL FG R	2 Kanal, Alarm Dolaylı Topraklama, Taban	8951780000	42,80 €	1
VSPC BASE 2SL	2 Kanal, Spark Gap ile Dolaylı, Taban	8924720000	32,00 €	1
VSPC BASE 2SL FG	2 Kanal, Doğrudan Topraklama, Taban	8924280000	37,50 €	1



VSPC 2SL 5VDC R

Serinin devamı sayfa 130

## Aşırı Gerilim Koruma Modülleri



MCZ OVP HF 5V 0,3A



VSPC 1CL 5VDC EX



VDATA CAT6



JPOVP RJ45 CAT6 IP20



V-TEST



V-TEST II

Tip	Açıklama	Sipariş No	Fiyat/Birim	Ambalaj
VSPC BASE 4SL R	4 Kanal, Alarm Doğrudan Topraklama, Taban	8951750000	69,50 €	1
VSPC BASE 4SL FG R	4 Kanal, Alarm Dolaylı Topraklama, Taban	8951760000	69,50 €	1
VSPC BASE 4SL	4 Kanal, Doğrudan Topraklama, Taban	8924700000	58,90 €	1
VSPC BASE 4SL FG	4 Kanal, Spark Gap ile Dolaylı, Taban	8924260000	64,50 €	1

### MCZ Serisi Yıldırım Korumalar

MCZ OVP HF 5V 0,3A	5 V UC / 0,3 A	8948620000	36,00 €	10
MCZ OVP HF 12V 0,3A	12 V UC / 0,3A	8948610000	36,00 €	10
MCZ OVP HF 24V 0,3A	24 V UC / 0,3 A	8948600000	37,00 €	10
MCZ OVP CL 24VDC 0,5A	24 V DC / 0,5 A	8448920000	40,00 €	10
MCZ OVP CL 24VAC 0,5A	24 V AC / 0,5 A	8472880000	36,50 €	10
MCZ OVP CL 24VUC 1,25A	24 V UC / 1,25 A	8448960000	39,65 €	10
MCZ OVP CL 48VUC 0,5A	48 V UC / 0,5 A	8449000000	43,70 €	10
MCZ OVP CL 48VUC 1,25A	48 V UC / 1,25 A	8449040000	53,10 €	10
MCZ OVP CL FG 24VUC 0,5A	24 V UC / 0,5 A	8704240000	53,40 €	10
MCZ OVP SL 24VDC 0,5A	24 V DC / 0,5 A	8448940000	40,00 €	10
MCZ OVP SL 24VUC 1,25A	24 V UC / 1,25 A	8448970000	39,75 €	10
MCZ OVP SL 48VUC 0,5A	48 V UC / 0,5 A	8449030000	44,85 €	10
MCZ OVP SL 48VUC 1,25A	48 V UC / 1,25 A	8449050000	46,35 €	10
MCZ OVP SL FG 24VUC 0,5A	24 V UC / 0,5 A	8823280000	44,25 €	10
MCZ OVP VARISTOR S10K30	24 V AC / 24 V DC / 16 A	8449140000	24,40 €	10
MCZ OVP TAZ DIODE 24VDC	24 V DC / 16 A	8449150000	24,80 €	10
MCZ OVP TAZ DIODE 24VUC	24 V UC / 16 A	8449160000	23,80 €	10

### Varitector - Patlayıcı Ortamlar için Ani Aşırı Gerilim Korumaları

#### Analog Sinyal Korumaları

VSPC 1CL 5VDC EX	20 kA, 1 Kanal, 5Vdc	8953660000	129,00 €	1
VSPC 1CL 12VDC EX	20 kA, 1 Kanal, 12Vdc	8953590000	129,00 €	1
VSPC 1CL 24VDC EX	20 kA, 1 Kanal, 24Vdc	8953600000	129,00 €	1
VSPC 2CL 24VDC EX	20 kA, 2 Kanal, 24Vdc	8953720000	193,00 €	1
VSPC BASE 1CL FG EX	1 Kanal, Taban	8951810000	53,50 €	1
VSPC BASE 2CL FG EX	2 Kanal, Taban	8951820000	85,70 €	1

#### Dijital Sinyal Korumaları

VSPC 2SL 12VDC EX	20 kA, 2 Kanal, 12VDC	8953620000	129,00 €	1
VSPC 2SL 24VDC EX	20 kA, 2 Kanal, 24VDC	8953670000	129,00 €	1
VSPC 2SL 48VAC EX	20 kA, 2 Kanal, 48VDC	8953640000	129,00 €	1
VSPC 4SL 12VDC EX	20 kA, 4 Kanal, 12 VDC	1161170000	247,00 €	1
VSPC 4SL 24VDC EX	20 kA, 4 Kanal, 24VDC	1161190000	247,00 €	1
VSPC 4SL 24VAC EX	20 kA, 4 Kanal, 48VAC	1161180000	247,00 €	1
VSPC BASE 2SL FG EX	2 Kanal, Taban	8951830000	53,50 €	1
VSPC BASE 4SL FG EX	4 Kanal, Taban	8951840000	85,70 €	1

### Cat 6 RJ45 Aşırı Gerilim Koruma

VDATA CAT6	Data hatları için aşırı gerilim koruma modülü	1348590000	141,00 €	1
------------	---	------------	----------	---

### JACKPAC IP68 Sinyal Dönüştürücüler

JPOVP RJ45 CAT6 IP20	Hazır Kablolü RJ45 Koruma modülü (3m kablo)	8805550000	105,00 €	1
----------------------	---	------------	----------	---

### V-Test Cihazları

V-TEST	VPU I ve VPU II serileri için	8951860000	1.480,00 €	1
* V-TEST II	VPU AC ve VPU PV serileri için	2661040000	60.000,00 TL	1

# PV Sistemler için Ürünler ve Çözümler



## PV Sistemler İçin Ürünler ve Çözümler



PV-STICK SET



PV-STICK - VPE10



BUGH WM4 C BT



VPU PV I-II 3 1000



VPU PV II 3 R 1500



WSI 25 10X85 1.5KV,14x85 gPV



SET MULTI-TOOL PV+

Tip	Açıklama	Kablo Kesiti	Sipariş No	Fiyat/Birim	Ambalaj
<b>PV STICK Konnektörleri</b>					
PV-STICK SET	PV-Stick Erkek-Dişi Set	4mm <sup>2</sup> - 6 mm <sup>2</sup> kablo kesitine uygun	1422030000	7,10 €	1
PV-STICK + VPE10	PV-Stick Dişi 10'lu paket	4mm <sup>2</sup> - 6 mm <sup>2</sup> kablo kesitine uygun	1303450000	3,55 €	10
PV-STICK - VPE10	PV-Stick Erkek 10'lu paket	4mm <sup>2</sup> - 6 mm <sup>2</sup> kablo kesitine uygun	1303490000	3,55 €	10
PV-STICK + VPE50	PV-Stick Dişi 50'li paket	4mm <sup>2</sup> - 6 mm <sup>2</sup> kablo kesitine uygun	1303460000	3,55 €	50
PV-STICK - VPE50	PV-Stick Erkek 50'li paket	4mm <sup>2</sup> - 6 mm <sup>2</sup> kablo kesitine uygun	1303500000	3,55 €	50
PV-STICK + VPE200	PV-Stick Dişi 200'ü paket	4mm <sup>2</sup> - 6 mm <sup>2</sup> kablo kesitine uygun	1303470000	3,55 €	200
PV-STICK - VPE200	PV-Stick Erkek 200'ü paket	4mm <sup>2</sup> - 6 mm <sup>2</sup> kablo kesitine uygun	1303510000	3,55 €	200

**Not:** PV Stick ile el aleti gerektirmeyen ve hızlı bağlantı

### WM4C PV Saha Konnektörleri

BUGH WM4 C BT	Dişi Konnektör	4mm <sup>2</sup> - 6 mm <sup>2</sup> kablo kesitine uygun	1530690000	1,25 €	100
SFGH WM4 C BT	Erkek Konnektör	4mm <sup>2</sup> - 6 mm <sup>2</sup> kablo kesitine uygun	1530700000	1,25 €	100
SFKO WM4 C BT	Erkek Kontak	4mm <sup>2</sup> - 6 mm <sup>2</sup> kablo kesitine uygun	1530680000	1,25 €	100
BUKO WM4 C BT	Dişi Kontak	4mm <sup>2</sup> - 6 mm <sup>2</sup> kablo kesitine uygun	1530670000	1,25 €	100

Hızlı ve Güvenilir Bağlantı / 30A kadar nominal akımlı yükler / TÜV sertifikalı ve en son DIN EN 50521 standardı ile uyumlu

### WM4C PV Combiner Box Konnektörleri

BUGH BOX WM4 C BT	Dişi Konnektör	4mm <sup>2</sup> - 6 mm <sup>2</sup> kablo kesitine uygun	1530630000	1,25 €	100
SFGH BOX WM4 C BT	Erkek Konnektör	4mm <sup>2</sup> - 6 mm <sup>2</sup> kablo kesitine uygun	1530640000	1,25 €	100
SFKO WM4 C BT	Erkek Kontak	4mm <sup>2</sup> - 6 mm <sup>2</sup> kablo kesitine uygun	1530680000	1,25 €	100
BUKO WM4 C BT	Dişi Kontak	4mm <sup>2</sup> - 6 mm <sup>2</sup> kablo kesitine uygun	1530670000	1,25 €	100

Tip	Açıklama	Sipariş No	Fiyat/Birim	Ambalaj
<b>PV Parafudrlar</b>				
VPU PV II 3 1000	PV Parafudr, Tip II, 1100 V DC, 40kA	2530550000	72,00 €	1
VPU PV II 3 R 1000	PV Parafudr, Tip II 1100 V DC, 40kA, remote sinyalli	2530180000	90,00 €	1
VPU PV I+II 3 1000	PV Parafudr, Tip I+II, 1100 V DC, 40kA	2530610000	151,00 €	1
VPU PV I+II 3 R 1000	PV Parafudr, Tip I+II 1100 V DC, 40kA, remote sinyalli	2530620000	190,00 €	1
VPU PV II 3 1500	PV Parafudr, Tip II 1500V DC, 30kA, limp: 5kA	2530640000	98,00 €	1
VPU PV II 3 R 1500	PV Parafudr, Tip II 1500V DC, 30kA, limp: 5kA, remote sinyalli	2530650000	108,00 €	1
VPU PV I+II 3 1500	PV Parafudr, Tip I+II 1500 V DC, 30 kA, limp: 5kA	2530580000	164,00 €	1
VPU PV I+II 3 R 1500	PV Parafudr, Tip I+II 1500 V DC, 30 kA, limp: 5kA, remote sinyalli	2530590000	176,00 €	1

### PV Uygulamalarına Özel 1500V Sigorta Yuvası

WSI 25 10X85 1.5KV,14x85 gPV	1000V (AC) / 1500V (DC) / 32A	2469360000	256,05 TL	5
------------------------------	-------------------------------	------------	-----------	---

### İzleme Sistemi

TC 16i+ 1K5 (standalone)	TC 16i+ 1K5 (standalone)	2433950000	880,00 €	1
TC BKE 1k5.4 (standalone)	BKE PV 1500V Güç Kaynağı	7791400879	350,00 €	1
PV KIT TC 16i+ 1K5 & BKE 1K5.4	1500V 16 String izleme + BKE Güç Kaynağı Paketi	7512000541	Sorunuz	Sorunuz
PV KIT TC 16i+ 1K5 & BKE 1K5.4 & SPD	1500V 16 String OVP korumalı izleme + Güç Kaynağı Paketi	7512000542	Sorunuz	Sorunuz
PV KIT TC16i+1k5 & SPD	1500V 16 String OVP korumalı izleme	7512000543	Sorunuz	Sorunuz

1 String için 30A DC / Modbus RTU over RS-485 / Analog ve Dijital girişler / Şönt Rezistans

### PV El Aletleri ve Aksesuarlar

SET MULTI-TOOL PV+	Konnektör Sıkıcı	1217280000	237,50 TL	1
multi-stripax PV	Kablo Soyucu	1190490000	4.750,00 TL	1
CTF PV WM4	Kontak Sıkma Pensesi	1222870000	6.048,00 TL	1
VSSO WM4 C	Erkek ve Dişi Gövdeleri için Üniversal Toz Kapağı(Toz Tapası)	1254870000	6,20 TL	100



PV 224S0FOC15V00-3TXPX15PWW



PV Next PVN1M113SXFV100TXPX10



PV Next PVN1M216SXFV200TXPX10

Tip	Açıklama	Sipariş No	Fiyat/Birim	Ambalaj
<b>Saha Uygulamaları için Combiner Box Çözümleri</b>				
DC Combiner Box	Müşteriye özel dizayn Combiner Box	<b>Sorunuz</b>	<b>Sorunuz</b>	Sorunuz
* DC Combiner Box PV 216S0FOC-15V003T7P015PWW	1500VDC İzlemeli 16 girişli Sigortalı Tip II Parafudrlu Combiner Box	<b>Sorunuz</b>	<b>Sorunuz</b>	Sorunuz
* DC Combiner Box PV 216S0FOC-15V003TXPX15PWW	1500VDC İzlemesiz 16 girişli Sigortalı Tip II Parafudrlu Combiner Box	<b>Sorunuz</b>	<b>Sorunuz</b>	Sorunuz
* DC Combiner Box PV 224S0FOC-15V003T7P015PWW	1500VDC İzlemeli 24 girişli Sigortalı Tip II Parafudrlu Combiner Box	<b>Sorunuz</b>	<b>Sorunuz</b>	Sorunuz
* DC Combiner Box PV 224S0FOC-15V003TXPX15PWW	1500VDC İzlemesiz 24 girişli Sigortalı Tip II Parafudrlu Combiner Box	<b>Sorunuz</b>	<b>Sorunuz</b>	Sorunuz
<b>Çatı Uygulamaları için Combiner Box Çözümleri</b>				
* PV Next PVN1M113SXFV10-0TXPX10	Tip I Parafudrlu 3 giriş 3 çıkış Sigortasız 1 MMPT	<b>2683110000</b>	<b>525,00 €</b>	1
* PV Next PVN1M216SXFV10-0TXPX10	Tip I Parafudrlu 3 giriş 3 çıkış Sigortasız 2 MMPT	<b>2683120000</b>	<b>968,00 €</b>	1
* PV Next PVN1M319SXFV10-0TXPX10	Tip I Parafudrlu 3 giriş 3 çıkış Sigortasız 3 MMPT	<b>2683130000</b>	<b>1.406,00 €</b>	1
* PV Next PVN1M113SXFV20-0TXPX10	Tip II Parafudrlu 3 giriş 3 çıkış Sigortasız 1 MMPT	<b>2683310000</b>	<b>444,00 €</b>	1
* PV Next PVN1M216SXFV20-0TXPX10	Tip II Parafudrlu 3 giriş 3 çıkış Sigortasız 2 MMPT	<b>2683320000</b>	<b>817,00 €</b>	1
* PV Next PVN1M319SXFV20-0TXPX10	Tip II Parafudrlu 3 giriş 3 çıkış Sigortasız 3 MMPT	<b>2683330000</b>	<b>1.157,00 €</b>	1

Sigortalı ve yük kesicili versiyonlar için bizimle iletişime geçiniz.





## Ürün Sıralı Listesi

Ürün Kodu	Birim Fiyat	Sayfa No	Ürün Kodu	Birim Fiyat	Sayfa No	Ürün Kodu	Birim Fiyat	Sayfa No	Ürün Kodu	Birim Fiyat	Sayfa No
<b>0100000000</b>			0383560000	6,72 TL	6	0545300000	123,20 TL	8	1015270000	1,45 €	76
0117500000	49,30 TL	73	0389000000	27,35 TL	8	0546000000	19,40 TL	8	1015280000	1,70 €	76
0119660000	24,45 TL	50	<b>0400000000</b>			0550160000	6,00 €	50	1015290000	2,10 €	76
0119760000	24,45 TL	50	0430500000	13,55 TL	4	0556660000	31,00 TL	11	1015300000	3,00 €	76
0119860000	28,10 TL	50	0430500000	13,55 TL	15	0565600000	0,355 TL	69	1015310000	2,00 €	76
0119960000	29,45 TL	50	0430600000	15,70 TL	4	0565700000	0,644 TL	69	1015320000	2,00 €	76
0120060000	31,00 TL	50	0430600000	15,70 TL	15	0565800000	0,841 TL	69	1015330000	2,50 €	76
0122800000	96,10 TL	73	0430700000	13,55 TL	4	0565900000	0,785 TL	69	1015340000	2,45 €	76
0126160000	28,10 TL	50	0430700000	13,55 TL	15	0566000000	1,08 TL	69	1015350000	2,80 €	76
0126260000	28,10 TL	50	0430900000	13,55 TL	4	0573200000	8,70 €	66	1016030000	3,16 TL	39
0137100000	2,50 €	50	0430900000	13,55 TL	15	0573300000	21,45 €	66	1016200000	52,55 TL	5
0164000000	24,45 TL	74	0430900000	13,55 TL	4	0573400000	20,00 €	66	1016700000	51,05 TL	3
0169900000	6,72 TL	8	0444200000	3,92 TL	69	0573500000	25,40 €	66	1016900000	51,80 TL	3
0171111687	0,382 TL	35	0459500000	10,75 TL	11	0573600000	77,65 €	66	1017700000	57,10 TL	3
0178100000	24,45 TL	74	0462900000	0,147 TL	69	0573700000	110,00 €	66	1018190000	3,16 TL	39
0186100000	0,211 TL	69	0463000000	0,147 TL	69	0576261198	0,728 TL	34	1018600000	111,55 TL	3
0186500000	0,196 TL	69	0463100000	0,147 TL	69	0576261199	0,728 TL	34	1018790000	25,00 €	98
0191860000	10,55 TL	6	0468660001	0,728 TL	34	0576261202	0,728 TL	34	1018800000	69,45 TL	3
0191900000	0,336 TL	69	0468660051	0,728 TL	34	0576261203	0,728 TL	34	1018840000	21,00 €	98
0194300000	5,60 TL	8	0468660101	0,728 TL	34	0586761001	70,00 €	50	1019000000	63,30 TL	3
0194400000	6,72 TL	8	0468660151	0,728 TL	34	0587160000	28,10 TL	50	1019100000	96,45 TL	5
0194500000	7,84 TL	8	0468660201	0,728 TL	34	<b>0600000000</b>			1019570000	13,10 €	77
<b>0200000000</b>			0473460001	0,728 TL	34	0620120000	122,30 TL	11	1019700000	774,00 TL	3
0213760000	24,45 TL	50	0473460051	0,728 TL	34	0620220000	85,55 TL	11	1020000000	5,38 TL	2
0213811687	0,382 TL	35	0473460101	0,728 TL	34	0620320000	74,10 TL	11	1020080000	5,38 TL	2
0236400000	115,00 TL	73	0473460151	0,728 TL	34	0620420000	53,20 TL	11	1020100000	6,72 TL	2
0236500000	117,80 TL	73	0473460201	0,728 TL	34	0631961187	0,728 TL	34	1020180000	6,72 TL	2
0243520000	90,05 TL	11	0475360000	11,30 TL	11	0631961203	0,728 TL	34	1020200000	11,35 TL	2
0244100000	0,280 TL	69	0475380000	9,34 TL	11	0632760000	39,20 TL	50	1020280000	11,35 TL	2
025211xxxx	0,382 TL	35	0492500000	0,560 TL	69	0635100000	0,269 TL	69	1020300000	15,45 TL	2
025261xxxx	0,382 TL	35	0494920000	53,20 TL	74	0641720000	60,40 TL	11	1020380000	15,45 TL	2
0266500000	15,10 TL	11	<b>0500000000</b>			0644960000	289,65 TL	55	1020400000	20,85 TL	2
0267200000	22,60 TL	8	0502660000	23,80 TL	11	0648661001	70,00 €	50	1020480000	20,85 TL	2
0273820000	22,40 TL	11	0502680000	23,80 TL	11	0687900000	11,50 TL	50	1020500000	46,80 TL	2
0273920000	24,45 TL	11	0502860000	17,20 TL	11	0690700000	0,147 TL	69	1020580000	46,80 TL	2
0274020000	33,05 TL	11	0502880000	17,20 TL	11	<b>1000000000</b>			1021290000	11,00 €	90
0274220000	45,30 TL	11	0508401694	13,55 €	35	1002690000	180,00 €	68	1021320000	11,20 €	90
0274420000	82,10 TL	11	0514200000	58,95 TL	73	1002700000	405,00 €	68	1021480000	11,00 €	90
0274620000	85,55 TL	11	0514400000	120,55 TL	73	1002710000	326,00 €	68	1021500000	18,60 TL	2
0282600000	0,109 TL	69	0514500000	68,80 TL	73	1002720000	259,00 €	68	1021510000	11,20 €	90
0282800000	0,180 TL	69	0518960001	0,728 TL	34	1002730000	247,00 €	68	1021580000	18,60 TL	2
0282900000	0,392 TL	69	0518960011	0,728 TL	34	1002740000	197,00 €	68	1022300000	69,65 TL	2
0291660000	1.344,00 TL	55	0518960021	0,728 TL	34	1002750000	189,00 €	68	1022600000	87,75 TL	4
0292460000	16,65 TL	36	0518960031	0,728 TL	34	1002760000	479,00 €	68	1022600000	87,75 TL	4
0298860000	19,40 TL	11	0518960041	0,728 TL	34	1003260000	245,00 €	32	1023300000	87,75 TL	4
<b>0300000000</b>			0518960051	0,728 TL	34	1010000000	22,60 TL	3	1023300000	87,75 TL	4
0307300000	32,45 TL	8	0518960061	0,728 TL	34	1010060000	30,00 €	90	1023400000	87,75 TL	4
0316500000	6,18 TL	11	0518960071	0,728 TL	34	1010070000	26,00 €	90	1023500000	87,75 TL	4
0316600000	11,95 TL	11	0518960081	0,728 TL	34	1010080000	30,00 €	90	1023600000	123,05 TL	4
0317000000	1,79 TL	69	0518960091	0,728 TL	34	1010090000	26,00 €	90	1023700000	6,72 TL	4
0317100000	2,13 TL	69	0522361075	0,728 TL	34	1010100000	29,85 TL	3	1023780000	6,72 TL	4
0317200000	2,24 TL	69	0522361076	0,728 TL	34	1010100000	29,85 TL	3	1024140000	280,00 €	35
0317300000	3,02 TL	69	0522361077	0,728 TL	34	1010200000	39,55 TL	3	1024500000	527,00 TL	2
0318000000	12,90 TL	8	0523060001	0,728 TL	34	1010300000	40,95 TL	3	1024580000	527,00 TL	2
0334900000	12,90 TL	50	0523060011	0,728 TL	34	1010400000	59,75 TL	3	1024600000	374,20 TL	2
0335700000	13,45 TL	8	0523060021	0,728 TL	34	1010500000	95,00 TL	3	1024680000	374,20 TL	2
0338300000	16,80 TL	8	0523060031	0,728 TL	34	1010680000	38,25 TL	3	1024700000	32,50 TL	2
0342000000	16,05 €	66	0523060041	0,728 TL	34	1010780000	38,90 TL	3	1025220000	2,54 TL	36
0342100000	25,40 €	66	0523060051	0,728 TL	34	1010880000	43,90 TL	3	1025230000	2,54 TL	36
0342200000	21,45 €	66	0523060061	0,728 TL	34	1010980000	51,80 TL	3	1025260000	2,82 TL	37
0342300000	28,15 €	66	0523060071	0,728 TL	34	1011000000	37,25 TL	4	1025270000	2,82 TL	37
0342400000	56,20 €	66	0523060081	0,728 TL	34	1011300000	91,45 TL	4	1025310000	3,16 TL	37
0342500000	62,90 €	66	0523060091	0,728 TL	34	1012200000	91,45 TL	4	1025320000	3,16 TL	37
0342600000	93,70 €	66	0525960000	16,25 TL	11	1012300000	91,45 TL	4	1025940015	37,55 €	98
0348900000	176,85 TL	11	0525980000	16,25 TL	11	1012400000	91,45 TL	4	1025940030	47,10 €	98
0354361187	0,728 TL	34	0531760000	8,33 TL	8	1015220000	0,95 €	76	1025940050	70,00 €	98
0382860000	6,65 TL	6	0533500000	0,464 TL	69	1015230000	1,05 €	76	1025940100	110,00 €	98
0383400000	63,85 TL	73	0534200000	0,616 TL	69	1015240000	1,05 €	76	1025950005	59,10 €	97
			0542500000	0,140 TL	69	1015250000	1,30 €	76	1025950015	80,00 €	97
									1025950030	75,05 €	97
									1025950050	90,00 €	97
									1025950100	106,00 €	97
									1027040000	133,00 €	35





Ürün Kodu	Birim Fiyat	Sayfa No	Ürün Kodu	Birim Fiyat	Sayfa No	Ürün Kodu	Birim Fiyat	Sayfa No	Ürün Kodu	Birim Fiyat	Sayfa No
1261300000	10,75 TL	11	1286930000	2.097,00 €	95	1315600000	210,00 €	82	1334810000	32,50 €	82
1267790000	518,00 TL	30	1286940000	2.097,00 €	95	1315610000	250,00 €	82	1334890000	405,00 €	80
1267800000	518,00 TL	30	1286970000	2.925,00 €	95	1315620000	225,00 €	81	1334900000	405,00 €	80
1267810000	518,00 TL	30	1286990000	3.546,00 €	95	1315650000	234,00 €	81	1334910000	369,00 €	80
1267820000	518,00 TL	30	1287000000	3.546,00 €	96	1315670000	235,00 €	81	1334920000	410,00 €	80
1267830000	237,35 TL	29	1287010000	3.872,00 €	95	1315680000	260,00 €	81	1334940000	400,00 €	80
1267840000	237,35 TL	29	1287020000	2.733,00 €	96	1315690000	250,00 €	81	1334950000	690,00 €	80
1267870000	254,70 TL	30	1289200000	0,784 TL	75	1315700000	222,00 €	82	1334990000	600,00 €	80
1267880000	254,70 TL	30	1289400000	1,01 TL	75	1315710000	234,00 €	82	1335030000	270,00 €	81
1267890000	123,05 TL	29	1296000000	1.114,00 TL	59	1315720000	265,00 €	81	1335040000	300,00 €	82
1267900000	123,05 TL	29				1315730000	285,00 €	81	1335050000	280,00 €	82
1267910000	131,70 TL	30				1315740000	240,00 €	82	1335140000	1.090,00 TL	115
1267920000	131,70 TL	30				1315750000	250,00 €	82	1338650000	160,00 €	35
1268360000	1.344,00 TL	55				1315770000	27,00 €	82	1338670000	160,00 €	35
1270040000	18,10 TL	12				1318061198	0,728 TL	34	1338680000	160,00 €	35
1270070000	66,25 TL	12				1318061199	0,728 TL	34	1338690000	160,00 €	35
1270080000	118,05 TL	12				1318061202	0,728 TL	34	1338710000	262,00 €	35
1274660000	190,20 TL	60				1318220000	470,00 €	117	1338720000	570,00 €	35
1274670000	224,40 TL	60				1318640000	2,03 TL	37	1339610000	51,00 €	98
1274680000	270,70 TL	60				1318650000	2,14 TL	37	1339920000	1,50 €	82
1274690000	353,60 TL	60				1318660000	2,24 TL	37	1341030000	2.009,00 TL	42
1274710000	251,10 TL	60				1318670000	2,24 TL	37	1341040000	2.009,00 TL	42
1274720000	338,95 TL	60				1318680000	2,34 TL	37	1341050000	2.009,00 TL	42
1274730000	290,25 TL	60				1318690000	2,43 TL	37	1341070000	2.009,00 TL	42
1274740000	402,40 TL	60				1318710000	2,24 TL	37	1341080000	2.009,00 TL	42
1274750000	1.303,00 TL	60				1318720000	2,24 TL	38	1341090000	2.009,00 TL	42
1275100000	256,80 TL	109				1318730000	2,34 TL	38	1341100000	2.009,00 TL	42
1276960001	0,773 TL	34				1318740000	2,34 TL	38	1341110000	2.009,00 TL	42
1276960011	0,773 TL	34				1318750000	2,43 TL	38	1341120000	3.013,00 TL	42
1276960021	0,773 TL	34				1318760000	2,34 TL	38	1341130000	6,72 TL	42
1276960031	0,773 TL	34				1319270000	160,00 €	111	1341140000	2,82 TL	42
1276960041	0,773 TL	34				1319280000	170,00 €	111	1341150000	4,97 TL	42
1278600000	0,078 TL	75				1320060000	20,15 TL	49	1341170000	4,03 TL	42
1278700000	0,179 TL	75				1320160000	29,10 TL	49	1341180000	4,30 TL	42
1278800000	0,336 TL	75				1324260000	21,50 TL	50	1341620000	0,813 TL	35
1278900000	0,478 TL	75				1324380000	5.700,00 €	35	1341630000	1,01 TL	82
1279000000	0,594 TL	75				1324460000	24,45 TL	50	1344760000	374,00 €	96
1279100000	1,28 TL	75				1327600000	71,80 TL	41	1344770000	1.419,00 €	95
1281760000	12,15 TL	49				1327620000	107,90 TL	41	1345240000	2.122,00 €	95
1281860000	18,10 TL	49				1327630000	14,20 TL	41	1345270000	1.580,00 €	96
1281960000	31,35 TL	49				1327640000	19,95 TL	41	1345310000	21.840,00 TL	63
1282060000	33,15 TL	49				1327650000	44,95 TL	41	1345320000	27.440,00 TL	64
1282160000	47,05 TL	49				1327670000	57,80 TL	41	1345330000	5.376,00 TL	64
1282260000	54,90 TL	49				1327680000	35,15 TL	42	1346610000	12,00 €	82
1282360000	62,70 TL	49				1327690000	44,35 TL	41	1348590000	141,00 €	98
1282460000	60,20 TL	49				1327700000	17,60 TL	41	1348590000	141,00 €	130
1282490000	63,00 €	115				1327720000	24,45 TL	41	1351350000	259,00 €	128
1282560000	78,40 TL	49				1327730000	14,55 TL	41	1351550000	69,50 €	128
1282660000	78,30 TL	50				1327740000	21,50 TL	41	1351570000	195,00 €	128
1282760000	82,75 TL	50				1327750000	17,60 TL	41	1351580000	75,00 €	128
1282820000	549,00 TL	55				1327770000	23,25 TL	41	1351600000	69,50 €	128
1282820000	549,00 TL	55				1327780000	21,50 TL	41	1351630000	69,50 €	128
1286530000	529,00 €	94				1327790000	26,95 TL	41	1351650000	80,00 €	128
1286540000	317,00 €	94				1327800000	71,80 TL	41	1351670000	558,00 €	128
1286550000	317,00 €	94				1327820000	107,90 TL	41	1351680000	53,50 €	128
1286560000	290,00 €	94				1327830000	44,95 TL	41	1351690000	650,00 €	128
1286570000	533,00 €	94				1327840000	57,80 TL	41	1351700000	53,50 €	128
1286580000	602,00 €	94				1327850000	35,15 TL	41	1351740000	347,00 €	128
1286590000	1.100,00 €	94				1327870000	44,35 TL	41	1351770000	737,00 €	128
1286610000	1.292,00 €	94				1327880000	17,60 TL	41	1351780000	702,00 €	128
1286620000	1.600,00 €	94				1327890000	24,45 TL	41	1351920000	180,00 €	128
1286780000	1.318,00 €	95				1327900000	14,55 TL	41	1352130000	85,00 €	128
1286790000	2.006,00 €	95				1327920000	21,50 TL	41	1352140000	80,00 €	128
1286800000	2.006,00 €	95				1331600000	1.000,00 €	35	1352150000	133,00 €	128
1286810000	2.559,00 €	95				1333100000	0,208 TL	69	1352170000	150,00 €	128
1286820000	2.370,00 €	95				1334710000	45,00 €	82	1352180000	257,00 €	128
1286830000	2.988,00 €	95				1334740000	45,00 €	82	1352190000	289,00 €	128
1286840000	2.988,00 €	95				1334770000	32,50 €	82	1352200000	193,00 €	128
1286860000	850,00 €	94				1334780000	32,50 €	82	1352220000	250,00 €	128
1286870000	847,00 €	94				1334790000	32,50 €	82	1352230000	364,00 €	128
1286920000	609,00 €	94				1334800000	32,50 €	82	1352240000	396,00 €	128







Ürün Kodu	Birim Fiyat	Sayfa No	Ürün Kodu	Birim Fiyat	Sayfa No	Ürün Kodu	Birim Fiyat	Sayfa No	Ürün Kodu	Birim Fiyat	Sayfa No
1764230000	1,12 TL	39	1784670000	162,00 €	89	1807340000	9,50 €	90	1826050000	96,45 TL	15
1764240000	1,12 TL	39	1784680000	180,00 €	89	1807350000	9,90 €	90	1826060000	8,06 TL	50
1764250000	1,12 TL	39	1784690000	200,00 €	89	1807360000	11,75 €	90	1826880000	30,00 €	91
1764260000	1,12 TL	39	1784700000	192,00 €	89	1807370000	15,00 €	90	1826890000	142,45 TL	7
1764270000	2,14 TL	39	1784740000	24,00 €	90	1810850000	4,64 TL	50	1826900000	197,95 TL	7
1764280000	2,14 TL	39	1784750000	24,00 €	90	1810860000	7,06 TL	50	1826910000	261,05 TL	7
1764290000	2,14 TL	39	1784780000	26,00 €	90	1811180000	3,76 TL	50	1828450000	1,19 TL	35
1764300000	2,14 TL	39	1784790000	26,00 €	90	1811190000	5,44 TL	50	1828450000	1,19 TL	108
1768000000	89,15 TL	14	1790410000	10,80 TL	40	1812630000	9,00 TL	40	1828450000	1,19 TL	110
1768010000	13,65 TL	16	1790420000	11,80 TL	40	1812870000	22,95 €	91	1828610000	207,00 €	89
1771800000	69,00 TL	15	1790430000	10,50 TL	40	1812890000	23,20 €	91	1828620000	171,00 €	89
1771810000	66,25 TL	15	1790650000	256,00 €	35	1813130000	1,67 TL	36	1828630000	298,00 €	89
1771870000	15,10 TL	16	1791100000	16,90 TL	14	1813160000	1,67 TL	36	1828640000	244,00 €	89
1771930000	9,00 TL	40	1791120000	42,45 TL	14	1813190000	1,86 TL	37	1828650000	255,00 €	89
1771950000	96,45 TL	15	1791160000	5,51 TL	16	1813210000	1,86 TL	37	1828660000	208,00 €	89
1771960000	61,05 TL	15	1794040000	50,50 TL	108	1813240000	1,88 TL	37	1828670000	150,00 €	89
1773220000	5,58 TL	40	1794040000	50,50 TL	109	1813260000	1,88 TL	37	1828680000	130,00 €	89
1773230000	5,58 TL	40	1794040000	50,50 TL	110	1814660000	12,75 TL	11	1828690000	189,00 €	89
1773880000	192,15 TL	47	1794050000	50,50 TL	108	1814670000	12,75 TL	11	1828700000	142,00 €	89
1774470000	1.996,00 TL	59	1794050000	50,50 TL	109	1814680000	12,75 TL	11	1828710000	119,00 €	89
1774480000	9.985,00 TL	59	1794050000	50,50 TL	110	1814690000	123,05 TL	15	1828720000	88,50 €	89
1775480000	7,26 TL	14	1794070000	207,55 TL	108	1814700000	166,95 TL	15	1831130000	36,60 TL	15
1775490000	7,26 TL	14	1794070000	207,55 TL	109	1815070000	14,15 TL	26	1831280000	41,65 TL	15
1776030000	4,91 TL	16	1794070000	207,55 TL	110	1815080000	26,20 TL	26	1833100000	59,00 TL	12
1776040000	4,91 TL	16	1794080000	207,55 TL	108	1815090000	20,10 TL	26	1833100000	59,00 TL	15
1776120000	5,11 TL	16	1794080000	207,55 TL	109	1815100000	34,55 TL	26	1833600000	74,15 TL	12
1776130000	10,15 TL	16	1794080000	207,55 TL	110	1815110000	23,80 TL	26	1833610000	84,10 TL	12
1776140000	13,65 TL	16	1798460000	61,80 TL	5	1815120000	36,60 TL	26	1833640000	119,35 TL	12
1776150000	17,20 TL	16	1798470000	0,644 TL	39	1815130000	20,10 TL	26	1834060000	73,35 TL	7
1776200000	43,90 TL	16	1798480000	0,644 TL	39	1815140000	34,55 TL	26	1834070000	102,95 TL	7
1779080001	1,86 TL	37	1798490000	0,449 TL	39	1815150000	34,55 TL	26	1834080000	134,45 TL	7
1779080004	1,86 TL	37	1798510000	0,449 TL	39	1815160000	52,55 TL	26	1836970000	28,00 €	90
1781540001	12,40 €	91	1798520000	0,517 TL	39	1815180000	163,95 TL	27	1839850000	12,15 TL	6
1781550001	14,00 €	91	1798530000	0,517 TL	39	1815190000	17,20 TL	27	1839850000	12,15 TL	
1782300000	49,00 TL	14	1798540000	0,377 TL	39	1815200000	30,95 TL	27	1846030000	543,00 TL	5
1782340000	8,67 TL	16	1798560000	0,377 TL	39	1815210000	40,95 TL	27	1846040000	358,95 TL	5
1782710000	7,06 TL	40	1798580000	0,492 TL	39	1815220000	54,65 TL	27	1848330000	59,75 TL	26
1782960000	0,90 €	38	1798600000	0,492 TL	39	1815280000	121,60 TL	27	1848340000	28,50 TL	27
1782970000	0,75 €	38	1798620000	0,352 TL	39	1815430000	16,05 TL	26	1848350000	34,55 TL	26
1782980000	0,90 €	38	1798640000	0,352 TL	39	1815440000	28,10 TL	26	1849670000	192,00 €	89
1782990000	8,74 TL	40				1815450000	40,95 TL	26	1849680000	111,00 €	89
1783000000	8,74 TL	40				1815500000	52,55 TL	26	1849690000	180,00 €	89
1783410000	23,05 €	91				1815510000	54,05 TL	26	1849700000	193,00 €	89
1783420000	23,05 €	91				1815520000	59,00 TL	26	1852360000	6,12 TL	38
1783430000	23,05 €	91				1815530000	68,25 TL	26	1852390000	6,12 TL	38
1783550000	15,05 TL	6				1815540000	76,95 TL	26	1852410000	6,12 TL	38
1783560000	67,00 TL	3				1815550000	86,40 TL	26	1852440000	6,12 TL	38
1783590000	63,95 TL	3				1815560000	121,60 TL	26	1852460000	6,12 TL	38
1783600000	92,80 TL	3				1815570000	124,45 TL	26	1852490000	6,12 TL	38
1783790000	54,90 TL	2				1815580000	125,20 TL	26	1854090000	1,37 TL	36
1783820000	52,55 TL	3				1815590000	126,60 TL	26	1854490000	0,685 TL	35
1783950000	99,25 TL	3				1815600000	133,05 TL	26	1854960000	21,15 TL	26
1783980000	99,25 TL	3				1815610000	142,45 TL	26	1854970000	36,60 TL	26
1784030001	12,95 €	91				1815620000	151,80 TL	27	1854990000	48,15 TL	27
1784040001	11,40 €	91				1816030000	4,91 TL	27	1855000000	63,95 TL	27
1784050001	14,00 €	91				1816050000	4,91 TL	27	1855010000	83,40 TL	27
1784060001	14,40 €	91				1816070000	6,45 TL	27	1855070000	213,65 TL	27
1784120000	43,25 TL	3				1816090000	6,45 TL	27	1855310000	2,60 €	91
1784130000	62,70 TL	3				1816240000	1,06 TL	36	1855610000	40,30 TL	3
1784150000	14,55 TL	6				1816250000	1,06 TL	36	1855620000	45,90 TL	3
1784160000	11,20 TL	6				1816260000	1,06 TL	36	1856650000	4.180,00 TL	42
1784180000	47,45 TL	2				1816290000	1,34 TL	36	1856740000	0,701 TL	35
1784210000	15,05 TL	6				1820550000	328,65 TL	5	1857440000	3,16 TL	41
1784570000	310,00 €	89				1820560000	328,65 TL	5	1860120000	6,12 TL	38
1784580000	203,00 €	89				1820840000	188,45 TL	4	1860150000	6,12 TL	38
1784590000	214,00 €	89				1820850000	188,45 TL	4	1864730000	34,95 €	90
1784600000	197,00 €	89				1820930000	96,45 TL	15	1864740000	36,00 €	90
1784610000	209,00 €	89				1822210000	570,00 TL	2	1865510000	33,05 TL	26
1784620000	173,00 €	89				1824810000	5,44 TL	50	1866690000	2,54 TL	41
1784630000	290,00 €	89				1824820000	8,06 TL	50	1866730000	737,00 TL	53
1784640000	170,00 €	89				1826040000	5,44 TL	50	1874760000	0,773 TL	39







## Ürün Sıralı Listesi

Ürün Kodu	Birim Fiyat	Sayfa No	Ürün Kodu	Birim Fiyat	Sayfa No	Ürün Kodu	Birim Fiyat	Sayfa No	Ürün Kodu	Birim Fiyat	Sayfa No
2465830000	128,00 €	118	2486100000	180,00 €	124	2506360000	268,80 TL	28	2556380000	201,60 TL	108
2466530000	36,45 TL	22	2486110000	205,00 €	124	2506370000	336,00 TL	28	2556380000	201,60 TL	110
2466600000	76,40 TL	22	2486640000	9,27 TL	23	2506380000	382,00 TL	28	2556400000	44,80 TL	107
2466610000	84,40 TL	22	2486660000	7,46 TL	22	2517450000	125,00 €	118	2556410000	201,60 TL	108
2466850000	150,00 €	123	2488560000	115,35 TL	52	2518250000	331,40 TL	31	2556420000	201,60 TL	108
2466870000	190,00 €	123	2488560000	115,35 TL	53	2518330000	615,00 TL	31	2556440000	36,95 TL	107
2466880000	270,00 €	123	2488580000	166,90 TL	52	2518340000	1.180,00 TL	31	2556450000	201,60 TL	107
2466890000	380,00 €	123	2488580000	166,90 TL	54	2518540000	549,00 TL	31	2556460000	201,60 TL	108
2466900000	800,00 €	123	2488590000	173,65 TL	53	2518570000	664,00 TL	31	2561430000	5.824,00 TL	62
2466910000	225,00 €	123	2488590000	173,65 TL	54	2519180000	1,23 TL	42	2566380000	428,00 €	80
2466920000	820,00 €	123	2488590000	173,65 TL	54	2519190000	1,17 TL	43	2566960000	250,00 €	81
2466980000	200,00 €	123	2488600000	185,25 TL	53	2519470000	1.081,00 TL	31	2566970000	410,00 €	81
2466990000	300,00 €	123	2488600000	185,25 TL	54	2519480000	1.075,00 TL	31	2576620000	538,00 TL	64
2467000000	500,00 €	123	2489830000	404,00 €	81	2519490000	1.100,00 TL	31	2578530000	30,00 €	123
2467010000	850,00 €	123	2490360000	25,65 TL	20	2521730000	831,00 TL	31	2578550000	27,00 €	123
2467030000	462,00 €	123	2490370000	25,65 TL	20	2522720000	29,00 TL	28	2578560000	36,00 €	123
2467290000	390,00 €	124	2490380000	9,95 TL	22	2522830000	61,60 TL	28	2580000000	29.167,00 €	64
2467300000	530,00 €	124	2490390000	9,95 TL	22	2522840000	36,30 TL	29	2580180000	32,00 €	123
2467310000	780,00 €	124	2490440000	55,95 TL	21	2522860000	65,30 TL	29	2580190000	48,00 €	123
2467320000	65,00 €	123	2490510000	40,40 TL	20	2522870000	31,90 TL	29	2580210000	50,00 €	123
2469360000	256,05 TL	132	2490520000	40,40 TL	20	2524850000	193,15 TL	32	2580220000	48,00 €	123
2469370000	16,85 TL	20	2490530000	10,50 TL	22	2526810000	29,95 €	78	2580230000	60,00 €	123
2469400000	37,85 TL	21	2490540000	10,50 TL	22	2527880000	173,00 €	78	2580240000	60,00 €	123
2469410000	59,75 TL	21	2490590000	81,55 TL	21	2527890000	180,00 €	78	2580250000	75,00 €	123
2471430000	16,85 TL	20	2491270000	37,15 €	125	2527900000	191,00 €	78	2580260000	75,00 €	123
2471450000	37,85 TL	21	2491280000	37,15 €	125	2527910000	222,00 €	78	2580270000	75,00 €	123
2476450000	430,00 €	80	2491290000	38,50 €	125	2527920000	197,00 €	78	2587360000	84,00 €	123
2482160000	9,95 TL	24	2494000000	32,55 TL	20	2527930000	209,00 €	78	2587360000	84,00 €	124
2482170000	9,95 TL	24	2494010000	62,95 TL	21	2527940000	219,00 €	78	2588460000	38,90 TL	73
2482180000	12,30 TL	24	2494020000	94,85 TL	21	2527950000	249,00 €	78	2588580000	49,45 TL	73
2482190000	12,30 TL	24	2494100000	32,55 TL	20	2530180000	90,00 €	132	2588630000	105,30 TL	73
2482200000	13,85 TL	24	2495040000	4,00 €	125	2530550000	72,00 €	132	2588720000	145,60 TL	73
2482210000	13,85 TL	24	2495070000	4,00 €	125	2530580000	164,00 €	132	2588770000	137,80 TL	73
2482220000	34,90 TL	25	2495080000	3,50 €	125	2530590000	176,00 €	132	2588790000	150,40 TL	73
2482230000	43,35 TL	25	2495090000	4,00 €	125	2530610000	151,00 €	132	2588850000	224,00 TL	73
2482240000	46,40 TL	25	2495100000	6,00 €	125	2530620000	190,00 €	132	2589110000	26,90 TL	73
2482250000	12,30 TL	25	2495380000	3,00 €	125	2530640000	98,00 €	132	2589130000	30,25 TL	73
2482260000	12,30 TL	25	2497250000	12,75 TL	23	2530650000	108,00 €	132	2589150000	43,70 TL	73
2482270000	12,30 TL	25	2497290000	17,30 TL	23	2534130000	5.000,00 €	120	2589180000	62,70 TL	73
2482280000	12,30 TL	25				2534160000	5.000,00 €	120	2589210000	40,30 TL	73
2482290000	12,30 TL	25				2535770000	131,00 €	78	2589230000	52,65 TL	73
2482300000	12,30 TL	25				2535810000	222,00 €	78	2589240000	71,70 TL	73
2482310000	12,30 TL	25				2535830000	286,00 €	78	2589260000	89,60 TL	73
2482320000	12,30 TL	25				2535850000	353,00 €	78	2589280000	50,40 TL	73
2482330000	12,30 TL	25				2535870000	420,00 €	78	2589300000	62,70 TL	73
2482340000	12,30 TL	25				2535890000	509,00 €	78	2589310000	78,40 TL	73
2482350000	20,70 TL	25				2535910000	553,00 €	78	2589330000	118,70 TL	73
2482360000	29,00 TL	25				2535930000	2.000,00 €	96	2589370000	76,15 TL	73
2482370000	37,40 TL	25				2535940000	1.900,00 €	96	2589380000	98,55 TL	73
2482380000	45,75 TL	25				2535960000	2.093,00 €	96	2589400000	128,80 TL	73
2482390000	54,15 TL	25				2536660000	850,00 €	96	2589420000	95,20 TL	73
2482400000	62,60 TL	25				2536650000	1.000,00 €	96	2589440000	118,70 TL	73
2482410000	70,85 TL	25				2536680000	1.100,00 €	97	2589450000	215,05 TL	73
2482420000	79,25 TL	25				2536690000	1.200,00 €	97	2589470000	143,85 TL	73
2482430000	87,65 TL	25				2539970000	26,30 TL	21	2589490000	153,45 TL	73
2482440000	50,40 TL	25				2539990000	78,40 TL	21	2589990000	100,80 TL	73
2482450000	42,00 TL	25				2540040000	26,30 TL	21	2590000000	82,75 TL	73
2482460000	33,15 TL	25				2548180000	425,60 TL	64	2590020000	72,25 TL	73
2482510000	6,12 TL	25				2548900000	141,10 TL	56	2590050000	61,70 TL	73
2482520000	6,12 TL	25				2549260000	141,10 TL	56	2590080000	31,60 TL	73
2483990000	189,60 TL	32				2551510000	55,35 TL	20	2590110000	18,10 TL	73
2485840000	19,25 TL	24				2551520000	86,90 TL	21	2591020000	32,00 €	128
2485850000	19,25 TL	24				2552090000	55,35 TL	20	2591030000	46,00 €	128
2485860000	44,35 TL	25				2555660000	515,00 €	85	2591040000	72,00 €	128
2485870000	68,50 TL	25				2555780000	680,00 €	85	2591050000	80,00 €	128
2485920000	43,30 TL	24				2555790000	974,00 €	85	2591060000	72,00 €	128
2485930000	43,30 TL	24				2555940000	265,00 €	82	2591070000	84,00 €	128
2485980000	5,51 TL	25				2556360000	40,30 TL	107	2591080000	119,00 €	128
2486070000	75,00 €	122				2556370000	40,30 TL	110	2591090000	150,00 €	128
2486080000	130,00 €	122				2556370000	201,60 TL	107	2591140000	122,00 €	128
2486090000	135,00 €	124				2556370000	201,60 TL	110	2591150000	140,00 €	128

Ürün Kodu	Birim Fiyat	Sayfa No
2591160000	110,00 €	128
2591170000	130,00 €	128
2592030000	246,40 TL	56
2592210000	280,00 TL	56
2592220000	309,55 TL	56
2592230000	309,55 TL	56
2592240000	309,55 TL	56
2592250000	207,90 TL	56
2592260000	87,30 TL	56
2599430000	2.200,00 €	35

Ürün Kodu	Birim Fiyat	Sayfa No
2659320000	0,990 TL	76
2659330000	1,46 TL	76
2659340000	1,83 TL	76
2659350000	3,29 TL	76
2659360000	4,97 TL	76
2659370000	0,672 TL	76
2659380000	0,841 TL	76
2659390000	1,43 TL	76
2659400000	1,53 TL	76
2659410000	3,29 TL	76
2659420000	4,97 TL	76
2659430000	0,672 TL	76
2659440000	0,990 TL	76
2659450000	1,42 TL	76
2659460000	1,53 TL	76
2659470000	3,29 TL	76
2659480000	4,97 TL	76
2659490000	0,605 TL	76
2659500000	0,990 TL	76
2659510000	1,42 TL	76
2659520000	1,53 TL	76
2659530000	3,29 TL	76
2659540000	4,97 TL	76
2659600000	4,48 TL	32
2659680000	290,00 €	80
2659690000	290,00 €	80
2659700000	290,00 €	80
2660130000	3.830,00 €	80
2660200277	25,50 €	126
2660200278	24,15 €	126
2660200279	23,85 €	126
2660200280	24,05 €	126
2660200281	30,95 €	126
2660200282	28,50 €	126
2660200283	27,85 €	126
2660200284	28,20 €	126
2660200285	32,75 €	126
2660200286	32,65 €	126
2660200287	32,70 €	126
2660200288	40,90 €	126
2660200289	39,65 €	126
2660200290	40,75 €	126
2660200291	71,00 €	126
2660200292	67,65 €	126
2660200293	70,85 €	126
2660200294	75,60 €	126
2660200295	78,30 €	126
2661040000	60.000,00 TL	130
2661280000	6,03 TL	9
2661310000	580,00 €	80
2663250000	156,80 TL	20
2663260000	156,80 TL	20
2663280000	336,00 TL	21
2665800000	2.205,00 €	84
2665810000	2.058,00 €	84
2665820000	5.775,00 €	84
2665830000	2.730,00 €	84
2668180000	77,70 TL	56
2668190000	77,70 TL	56
2676340000	1.785,00 €	84
2676350000	2.268,00 €	84
2676370000	2.394,00 €	84
2676380000	2.541,00 €	84
2676390000	3.150,00 €	84
2676400000	3.843,00 €	84
2676410000	4.788,00 €	84
2676420000	5.460,00 €	84
2676430000	2.520,00 €	84
2676450000	3.045,00 €	84
2676460000	3.360,00 €	84
2676470000	3.255,00 €	84

Ürün Kodu	Birim Fiyat	Sayfa No
2676480000	3.570,00 €	84
2676490000	3.500,00 €	84
2676500000	3.780,00 €	84
2676510000	4.032,00 €	84
2676520000	5.817,00 €	85
2676530000	4.305,00 €	85
2676540000	6.069,00 €	85
2676550000	5.124,00 €	85
2676560000	6.930,00 €	85
2676570000	5.439,00 €	85
2676580000	7.350,00 €	85
2676660000	2.121,00 €	85
2676670000	2.247,00 €	85
2676680000	2.415,00 €	85
2676690000	3.150,00 €	85
2676700000	3.654,00 €	85
2676710000	25,20 €	84
2676720000	49,35 €	84
2682620000	982,00 €	96
2683110000	525,00 €	133
2683120000	968,00 €	133
2683130000	1.406,00 €	133
2683310000	444,00 €	133
2683320000	817,00 €	133
2683330000	1.157,00 €	133
2683640000	32.816,00 TL	64
2683720000	26.880,00 TL	64
2697250000	655,00 TL	108
2697270000	782,00 TL	108
2697280000	595,00 TL	108
2697290000	595,00 TL	108

Ürün Kodu	Birim Fiyat	Sayfa No
4058630000	59,60 TL	100
<b>4100000000</b>		
4144870000	338,15 TL	50
4157440000	269,10 TL	50

Ürün Kodu	Birim Fiyat	Sayfa No
<b>4300000000</b>		
4323210000	4,00 €	32
4323220000	3,50 €	32
4323230000	4,00 €	32
4323240000	3,35 €	32
4329610000	3,35 €	32

Ürün Kodu	Birim Fiyat	Sayfa No
<b>7500000000</b>		
7512000541	Sorunuz	132
7512000542	Sorunuz	132
7512000543	Sorunuz	132

Ürün Kodu	Birim Fiyat	Sayfa No
<b>7700000000</b>		
7730000011	30,85 TL	73
7730000012	63,20 TL	73
7730000013	35,75 TL	73
7730000014	72,90 TL	73
7730000015	9,18 TL	74
7730000016	10,10 TL	74
7730000017	12,30 TL	74
7730000018	13,45 TL	74
7730000019	15,70 TL	74
7730000020	16,80 TL	74
7730000021	26,90 TL	74
7730000022	29,10 TL	74
7730000023	33,60 TL	74
7730000025	58,25 TL	74
7730000026	11,20 TL	74
7730000027	11,20 TL	74
7730000028	12,30 TL	74
7730000029	13,45 TL	74
7730000031	14,80 TL	74
7730000032	15,70 TL	74
7730000033	21,30 TL	74
7730000035	26,90 TL	74
7730000037	52,65 TL	74
7730000409	19,05 TL	74
7730000458	71,70 TL	73
7730000459	8,96 TL	74
7730000460	40,30 TL	74
7730000461	63,85 TL	74
7730000481	39,20 TL	74
7730000489	23,50 TL	74
7730000490	78,55 TL	73
7760054115	260,00 €	114
7760054117	275,00 €	114
7760054119	200,00 €	114
7760054120	158,00 €	114
7760054121	200,00 €	114
7760054122	210,00 €	114
7760054123	150,00 €	114
7760054124	230,00 €	114
7760054164	200,00 €	115
7760054165	220,00 €	115
7760054175	127,00 €	117
7760054176	144,00 €	117
7760054177	138,00 €	117
7760054178	121,00 €	117
7760054179	83,00 €	117
7760054180	99,00 €	117
7760054181	92,00 €	117
7760054182	94,00 €	117
7760054244	154,00 €	118

Ürün Kodu	Birim Fiyat	Sayfa No
<b>2600000000</b>		
2602200000	7.616,00 TL	62
2602310000	21.000,00 TL	64
2602750000	1,20 TL	76
2602760000	2,67 TL	76
2602770000	3,09 TL	76
2602780000	6,65 TL	76
2602790000	8,27 TL	76
2602800000	14,65 TL	76
2614380000	390,00 €	80
2617520000	225,00 €	81
2618000000	104,70 TL	107
2618010000	189,90 TL	107
2618050000	189,90 TL	107
2618150000	237,70 TL	107
2618200000	237,70 TL	107
2618220000	137,35 TL	107
2619830000	0,567 TL	42
2624980000	70,00 €	124
2624990000	74,00 €	124
2625000000	105,00 €	124
2625010000	450,00 €	80
2627630000	740,00 €	124
2627640000	480,00 €	124
2627650000	360,00 €	124
2627660000	740,00 €	124
2635980000	147,00 TL	56
2635990000	147,00 TL	56
2636060000	153,30 TL	56
2636070000	153,30 TL	56
2636080000	147,00 TL	56
2636090000	147,00 TL	56
2636180000	134,40 TL	56
2636190000	134,40 TL	56
2637320000	36,10 TL	56
2637340000	36,10 TL	56
2638920000	825,00 €	80
2639560000	497,90 TL	108
2639730000	Sorunuz	108
2656670000	68,00 €	124
2657930000	16,00 TL	31
2657970000	20,55 TL	31
2658010000	26,60 TL	32
2658030000	32,00 TL	32
2658210000	39,25 TL	32
2658230000	61,00 TL	32
2658270000	45,00 TL	32
2658510000	53,45 TL	32
2658550000	71,90 TL	32
2658630000	86,40 TL	32
2658830000	110,00 TL	32
2658850000	86,10 TL	32
2658890000	110,25 TL	32
2658970000	3,70 TL	32
2658990000	4,48 TL	32
2659030000	5,94 TL	32
2659040000	24,10 TL	32
2659050000	36,95 TL	32
2659060000	36,95 TL	32
2659310000	0,672 TL	76

Ürün Kodu	Birim Fiyat	Sayfa No
<b>2700000000</b>		
2705650000	2.280,00 €	85
2705660000	3.420,00 €	85
2705670000	4.560,00 €	85
2705680000	6.840,00 €	85
2705690000	8.436,00 €	85
2705710000	11.172,00 €	85
2705720000	17.100,00 €	85
2705740000	1.254,00 €	85
2705750000	1.938,00 €	85
2705760000	3.192,00 €	85
2705770000	4.560,00 €	85
2705780000	5.700,00 €	85
2705800000	10.032,00 €	85
2705810000	15.048,00 €	85
2705820000	433,00 €	80
2705830000	1.322,00 €	80
2708630000	182,00 €	80
2710090000	57,35 TL	9
2710100000	68,15 TL	9
2710170000	5,29 TL	9
2710190000	9,50 TL	9
2710210000	23,10 TL	9
2710220000	0,680 TL	9
2710230000	0,718 TL	9
2710300000	1,08 TL	9
2710440000	5,41 TL	9
2710450000	16,10 TL	9
2710460000	23,55 TL	9
2715590000	7.000,00 €	35
2740900000	60.000,00 €	64
2751270000	1.100,00 €	96
2751280000	1.800,00 €	96

Ürün Kodu	Birim Fiyat	Sayfa No
<b>4000000000</b>		
4058570000	29,95 TL	100
4058600000	38,55 TL	100
4058610000	61,60 TL	100





## Ürün Sıralı Listesi

Ürün Kodu	Birim Fiyat	Sayfa No
9046350000	477,90 TL	61
9046360000	477,90 TL	61
9046370000	519,00 TL	61
9046380000	529,00 TL	61
9046390000	590,00 TL	61
9046400000	597,00 TL	61
9046410000	659,00 TL	61
9046420000	663,00 TL	61
9046430000	659,00 TL	60

9200000000		
9200070000	0,672 TL	70
9200080000	0,672 TL	70
9200090000	0,813 TL	70
9200100000	0,784 TL	70
9200110000	1,23 TL	70
9200150000	0,829 TL	70
9200170000	0,996 TL	70
9200180000	0,996 TL	70
9200190000	1,32 TL	70
9200200000	1,34 TL	70
9200230000	1,76 TL	70
9200240000	1,75 TL	70
9200250000	2,02 TL	70
9200260000	2,43 TL	70
9200290000	0,762 TL	70
9200300000	0,784 TL	70
9200310000	0,785 TL	70
9200320000	0,896 TL	70
9200330000	1,27 TL	70
9200360000	0,952 TL	70
9200370000	0,913 TL	70
9200380000	0,986 TL	70
9200390000	1,34 TL	70
9200410000	1,68 TL	70
9200420000	1,77 TL	70
9200430000	2,13 TL	70
9200440000	2,82 TL	70
9200460000	0,934 TL	71
9200470000	1,14 TL	71
9200480000	2,18 TL	71
9200490000	1,01 TL	71
9200500000	1,12 TL	71
9200510000	1,90 TL	71
9200540000	1,00 TL	71
9200560000	1,09 TL	71
9200570000	1,52 TL	71
9200580000	1,01 TL	71
9200590000	1,03 TL	71
9200600000	1,43 TL	71
9200640000	1,09 TL	71
9200650000	1,18 TL	71
9200660000	1,83 TL	71
9201650000	5.417,00 TL	61
9202040000	8.803,00 TL	58
9202060000	12.797,00 TL	58
9202080000	24.156,00 TL	58
9202210000	5.741,00 TL	58
9202210000	5.741,00 TL	82
9202460000	27.005,00 TL	63
9202470000	2.072,00 TL	64
9202610000	9.985,00 TL	61
9202640000	3.522,00 TL	61
9202800000	7.176,00 TL	98
9202850000	3.731,00 TL	59
9202860000	8.684,00 TL	58
9203160000	16.143,00 TL	62
9204190000	1.467,00 TL	58
9204350000	1.352,00 TL	58
9205400000	1.415,00 TL	61
9205400000	1.415,00 TL	98

Ürün Kodu	Birim Fiyat	Sayfa No
9205430000	22.308,00 TL	59
9205440000	22.308,00 TL	59
9205560000	1.292,00 TL	60

9400000000		
9423580000	3.797,00 TL	61
9425830000	1.527,00 TL	61
9427300000	2.048,00 TL	61
9427370000	4.658,00 TL	61
9427460000	4.846,00 TL	61
9427520000	3.522,00 TL	61
9456050000	0,55 €	91
9456180000	98,65 €	88
9456190000	80,80 €	88
9456200000	87,75 €	88
9456210000	141,00 €	88
9456230000	187,00 €	88
9456320000	108,00 €	88
9456330000	103,00 €	88
9456340000	140,00 €	88
9456350000	165,00 €	88
9456370000	235,00 €	88
9456460000	144,00 €	88
9456470000	117,00 €	88
9456480000	124,00 €	88
9456490000	161,00 €	88
9456510000	199,00 €	88
9456600000	146,00 €	88
9456610000	144,00 €	88
9456620000	154,00 €	88
9456630000	187,00 €	88
9456650000	238,00 €	88
9456740000	149,00 €	88
9456750000	120,00 €	88
9456760000	121,00 €	88
9456770000	177,00 €	88
9456790000	238,00 €	88
9456880000	157,00 €	88
9456890000	140,00 €	88
9456900000	190,00 €	88
9456910000	258,00 €	88
9456930000	258,00 €	88

9500000000		
9512190000	254,70 TL	4
9512200000	481,95 TL	5
9512240000	95,00 TL	7
9512250000	138,15 TL	7
9512420000	254,70 TL	5
9531290000	174,15 TL	7
9532440000	84,10 TL	4
9532470000	19,55 TL	6
9535170000	17,50 €	66
9535210000	20,00 €	66
9535230000	19,00 €	66
9535290000	23,80 €	66
9535470000	48,65 €	66
9535690000	53,55 €	66
9535710000	69,00 €	66
9535730000	93,00 €	66
9535750000	95,15 €	66
9535770000	113,00 €	66
9535810000	215,00 €	66
9540000000	6,79 TL	6
9540000000	6,79 TL	16

9900000000		
9918130000	363,35 TL	60
9918140000	356,05 TL	60
9918150000	363,35 TL	60

Ürün Kodu	Birim Fiyat	Sayfa No
9918700000	37.933,00 TL	58
9918840000	2.887,00 TL	61
9918860000	1.186,00 TL	61
9918870000	2.723,00 TL	61
9918880000	1.074,00 TL	61
9918950000	386,95 TL	61

So00000000		
Sorunuz	Sorunuz	55
Sorunuz	Sorunuz	55
Sorunuz	Sorunuz	55
Sorunuz	Sorunuz	55
Sorunuz	Sorunuz	133
Sorunuz	Sorunuz	133
Sorunuz	Sorunuz	133
Sorunuz	Sorunuz	133

Ürün Kodu	Birim Fiyat	Sayfa No
-----------	-------------	----------

## Yetkili Bayilerimiz

### ADANA

ÖZTEKNİK ENERJİ  
Tel : (322) 359 30 60  
Fax : (322) 394 47 44  
E - mail : info@ozteknikenerji.com

### ADAPAZARI

AKIŞIK  
Tel : (264) 291 43 05  
Fax : (264) 291 45 42  
E - mail: akisikelektrik@gmail.com

### ELPİM ELEKTRİK

Tel : (264) 276 00 83  
Fax : (264) 275 19 00  
E - mail: elpim@elpim.com.tr

### ANKARA

ALPAN  
Tel : (312) 354 96 63  
Fax : (312) 354 96 66  
E - mail: alpan@alpanelektrik.com

### ARDA

Tel : (312) 385 80 37  
Fax : (312) 385 80 58  
E-mail: arda@ardaelektrik.com

### ANTALYA

GÜNEŞTOPU ELEKTRİK  
Tel: (242) 344 6434  
Fax: (242) 221 6607  
Mail: info@gunestopuelektrik.com

### BURSA

HARMES ELEKTRİK  
Tel : (224) 443 04 52  
Fax : (224) 443 04 53  
E-mail: harmes@harmeselektrik.com

### FRM OTOMASYON

Tel: (224) 441 05 11  
Fax: (224) 441 05 15  
E-mail: satis@frmotomasyon.com.tr

### DENİZLİ

MATEK OTOMASYON  
Tel : (258) 263 03 13  
Fax : (258) 263 14 08  
E - mail: info@matekotomasyon.com

### ESKİŞEHİR

KIRAÇ ELEKTRİK  
Tel : (222) 236 15 00  
Fax : (222) 236 15 01  
E-mail: kirac@kiracelektrik.com.tr

### GAZİANTEP

GEYLANİ ENERJİ  
Tel : (342) 215 30 60  
Fax : (342) 215 30 64  
E-mail: geylani@geylanienerji.com

### İSTANBUL ANADOLU

BOTEK OTOMASYON (ÜMRANİYE)  
Tel: (216) 527 75 31  
Fax: (216) 321 58 43  
Mail: botek@botekotomasyon.com

### DOLFIN ELEKTRİK / MARİN (TUZLA)

Tel: (216) 446 05 11  
Fax: (216) 44613 37  
Mail: info@dolfinelektrik.com.tr

### ELŞİS ELEKTRİK (ÜMRANİYE)

Tel : (216) 466 98 03  
Fax : (216) 466 98 59  
E-mail: info@elsiselektrik.com.tr

### SARNİKON / PCB (ATAŞEHİR)

Tel : (212) 593 71 71  
Fax : (212) 593 71 72  
E-mail: info@sarnikon.com

### İSTANBUL - AVRUPA

ERGİN ELEKTRİK (PERPA)  
Tel : (212) 220 13 13  
Fax : (212) 222 88 20  
E-mail: danisma@ergin.com.tr

### SOYLU OTOMASYON (İKİTELLİ)

Tel : (212) 671 33 56  
Fax : (212) 671 33 60  
E-mail: info@soyluotomasyon.com

### ÜÇ - EL ELEKTRİK (KARAKÖY)

Tel : (212) 297 03 71  
Fax : (212) 237 63 43  
E-mail: ucel@uceelektrik.com.tr

### VEGA ELEKTRİK (PERPA)

Tel : (212) 320 84 20  
Fax : (212) 320 94 20  
E-mail: info@vegaelektrik.com.tr

### İZMİR

BOLEM ELEKTRİK  
Tel : (232) 469 95 95  
Fax : (232) 469 78 69  
E-mail: bolem@bolemelk.com

### TEM

Tel : (232) 441 61 11  
Fax : (232) 457 44 75  
E-mail: temelektrik@temelektrik.com

### KAYSERİ

OKSİS OTOMASYON  
Tel : (352) 311 53 11  
Fax : (352) 311 53 22  
E-mail: info@oksis.com.tr

### KOCAELİ

GENESİS OTOMASYON  
Tel : (262) 323 26 06  
Fax : (262) 321 58 43  
E-mail: teklif@genesisotomasyon.com

### KONYA

ŞALT OTOMASYON  
Tel : (332) 345 31 81  
Fax : (332) 345 31 84  
E-mail: info@saltotomasyon.com

### SAMSUN

GALİP MÜHENDİSLİK  
Tel : (362) 435 27 13  
Fax : (362) 431 50 05  
E-mail: galip@galip.com.tr

### TEKİRDAĞ

BOTEM BOBİNAJ (ÇORLU)  
Tel : (282) 652 33 56  
Fax : (282) 653 21 68  
E-mail: info@botem.com.tr

## Otomasyon Partnerlerimiz

### ESKİŞEHİR

ANOT (ESKİŞEHİR)  
Tel : (222) 236 16 16  
Fax : (222) 236 16 11  
E-mail: bilgi@anot.com.tr

### GAZİANTEP

BİRMAG (GAZİANTEP)  
Tel : (342) 215 05 04  
Fax : (342) 215 05 99  
E-mail: birmag@birmag.com

### KONYA

SİMKON (KONYA)  
Tel : (332) 346 16 00  
Fax : (332) 346 16 02  
E-mail: info@simkonmuhendislik.com

### İSTANBUL ANADOLU

İSTANBUL SENSÖRLER (ÜMRANİYE)  
Tel: (216) 520 31 50  
Fax: (216) 520 31 84  
E-mail: bilgi@isac.com.tr

### SGS AUTOMATION & DRIVES (GEBZE)

Tel : (262) 641 63 43  
Fax : (262) 641 72 62  
E-mail: sgs@sgsteknik.com

### YÖN OTOMASYON (ÜMRANİYE)

Tel : (216) 415 72 24  
Fax : (216) 415 72 84  
E-mail: info@yonotomasyon.com

### İZMİR

GEOTEK OTOMASYON  
Tel : (530) 382 14 84  
Fax : (232) 433 47 81  
E-mail: satis@geotekotomasyon.com

### Pİ OTOMASYON

Tel : (232) 435 42 77  
Fax : (232) 435 42 71  
E-mail: info@piotomasyon.com.tr

## Satış Koşulları

Fiyat Listesi için geçerli olan Genel Satış Koşullarımıza; [www.weidmuller.com.tr](http://www.weidmuller.com.tr) adresindeki "Fiyat Listesi" bölümünden ulaşabilirsiniz.





# Weidmüller Hakkında

Deneyimli uzmanlar olarak, dünyanın dört bir yanındaki müşterilerimize ve ortaklarımıza güç, sinyal ve veri sanayi ortamında ürünler, çözümler ve hizmetler ile destek oluyoruz. Müşterilerimizin endüstrilerinde ve pazarlarında bulunuyor, yarının teknolojik zorluklarını biliyoruz. Bu yüzden müşterilerimizin bireysel ihtiyaçları için sürekli yenilikçi, sürdürülebilir ve faydalı çözümler geliştiriyoruz. Birlikte Endüstriyel Bağlantıdaki standartları belirliyoruz. Weidmüller Grubu'nun 80'den fazla ülkede üretim tesisleri, satış şirketleri ve temsilcileri bulunuyor.

## Dünya Çapındaki Adreslerimiz

Let's connect.

Satış Organizasyonu	●
Yurtdışı Temsilciliği	●
Distribütör	●

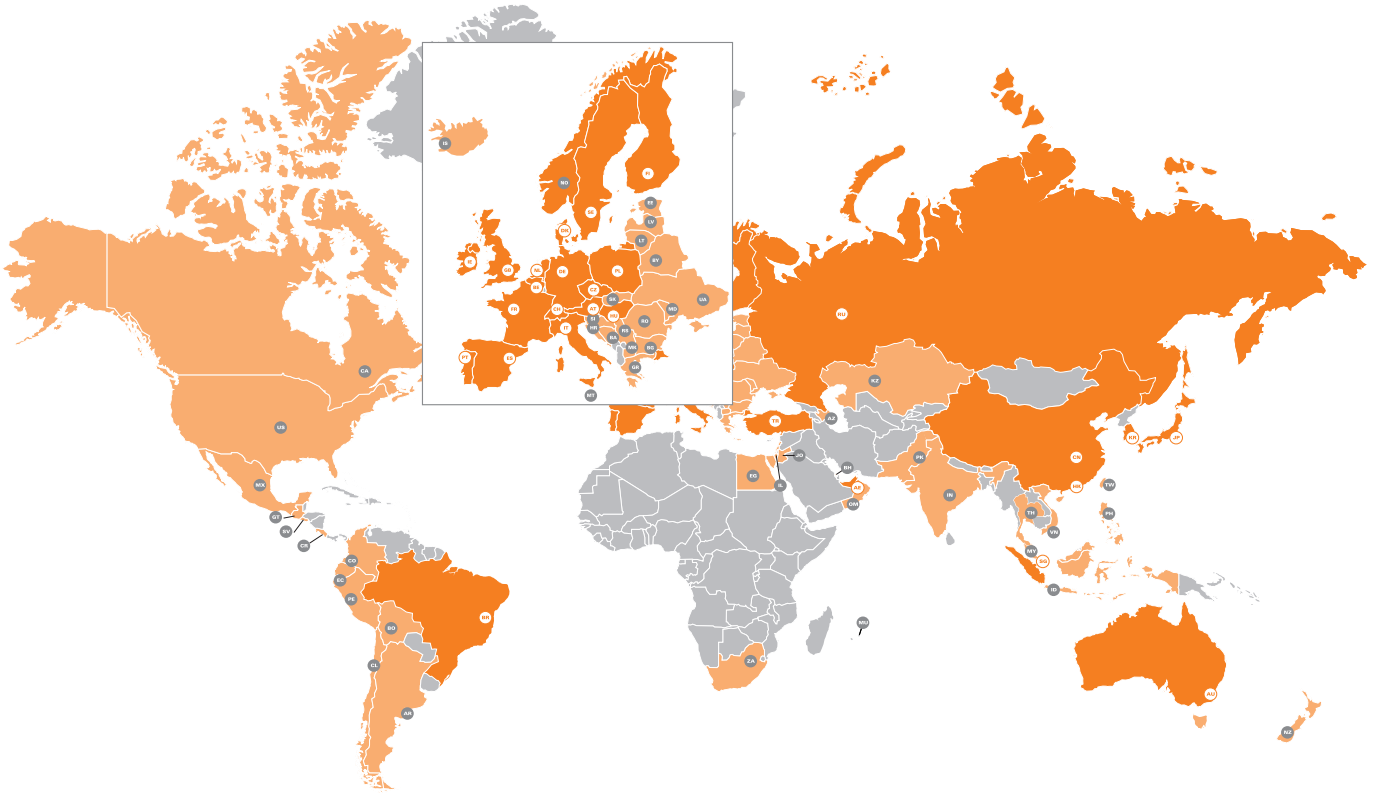

**Weidmüller Elektronik Ticaret Ltd. Şti.** | Çubuklu Mah. Orhan Veli Kanık Cad. 9, 34805 Beykoz - İstanbul, Turkey

Tel. 0216 537 10 70 | Faks 0216 537 10 77 | E-mail: info@weidmueller.com.tr | www.weidmueller.com.tr

### Adana Bölge

Tel. 0533 764 48 42

### Ankara Bölge

Tel. 0533 348 49 62

### Bursa Bölge

Tel. 0530 978 98 46

### Denizli Bölge

Tel. 0549 573 73 20

### Gaziantep Bölge

Tel. 0533 764 48 43

### İzmir Bölge

Tel. 0530 236 37 50

### Kocaeli Bölge

Tel. 0533 344 61 89

### Konya Bölge

Tel. 0530 978 98 47

### Samsun Bölge

Tel. 0534 890 11 28