

# 2021-2 ÜRÜN KATALOĞU ve FİYAT LİSTESİ

## PRODUCTS CATALOGUE and PRICE LIST

KANAL TİPİ, ÇATI TİPİ VE HÜCRELİ FANLAR / IN-LINE FANS, ROOF FANS AND VENTILATION UNITS

2021-2 FİYAT LİSTESİ / 2021-2 PRICE LIST

## YKA

### YUVARLAK KANAL TİPİ RADYAL FANLAR

#### CYLINDRICAL IN-LINE RADIAL FANS



#### TEKNİK DEĞERLER / TECHNICAL PARAMETERS

Tip Type	Voltaj Voltage V	Frekans Frequency Hz	Güç Power W	Akım Current A	Kondansatör Capacitor (µF/Volt)	Devir Speed d/d	Hava Debisi Air Flow m³/h	Ses Seviyesi Sound Pressure Level dB(A)	Ağırlık Weight Kg	Ambalaj Package Adet	Fiyat Price TL
YKA-100B-K-M	220	50	75	0,32	2,5/400	2500	260	45	3,50	1	490,00
YKA-125B-2K-M	220	50	85	0,35	2,5/400	2500	355	50	3,65	1	500,00
YKA-150B-2K-M	220	50	85	0,37	2,5/400	2500	400	52	3,90	1	520,00
YKA-160B-2K-M	220	50	85	0,45	2,5/400	2520	730	53	4,15	1	530,00
YKA-200B-2K-M	220	50	110	0,63	4/400	2550	1000	52	4,65	1	730,00
YKA-250B-2K-M	220	50	160	0,81	4/400	2580	1320	54	4,80	1	780,00
YKA-315B-2K-M	220	50	220	1,20	6/400	2620	1950	55	5,85	1	890,00

Ses seviyesi 3m mesafeden ölçülmüştür. / Sound level has measured at a distance of 3 meters.

## YBA

### YUVARLAK KANAL TİPİ AKSİYEL FANLAR

#### CYLINDRICAL IN-LINE AXIAL FANS



#### TEKNİK DEĞERLER / TECHNICAL PARAMETERS

Tip Type	Voltaj Voltage V	Frekans Frequency Hz	Güç Power W	Akım Current A	Kondansatör Capacitor (µF/Volt)	Devir Speed d/d	Hava Debisi Air Flow m³/h	Ses Seviyesi Sound Pressure Level dB(A)	Ağırlık Weight Kg	Ambalaj Package Adet	Fiyat Price TL
YBA-200-2K-M	220	50	85	0,39	2,5	2750	750	49	3,10	1	405,00
YBA-250-2K-M	220	50	110	0,44	2,5	2650	1800	53	3,80	1	450,00
YBA-315-2K-M	220	50	150	0,70	4	2570	2450	53	5,30	1	550,00
YBA-355-2K-M	220	50	230	1,00	6	2450	3800	59	6,00	1	630,00

Ses seviyesi 3m mesafeden ölçülmüştür. / Sound level has measured at a distance of 3 meters.

# DKF



## DİKDÖRTGEN KANAL TİPİ RADYAL FANLAR RECTANGULAR IN-LINE RADIAL FANS

### TEKNİK DEĞERLER / TECHNICAL PARAMETERS

Tip Type	Voltaj Voltage V	Frekans Frequency Hz	Güç Power W	Akım Current A	Kondansatör Capacitor (µF/Volt)	Devir Speed d/d	Hava Debisi Air Flow m³/h	Ses Seviyesi Sound Pressure Level dB(A)	Ağırlık Weight Kg	Ambalaj Package Adet	Fiyat Price TL
DKF-30/15-2K-M	220	50	95	0,43	2,5/400	2280	480	47	8,00	1	1.360,00
DKF-40/20A-2K-M	220	50	104	0,47	4/400	2645	950	54	12,00	1	1.570,00
DKF-40/20B-2K-M	220	50	145	0,65	5/400	2635	1150	57	13,50	1	1.775,00
DKF-50/25-2K-M	220	50	210	1,10	7/400	2660	1610	51	16,00	1	2.220,00
DKF-60/30-4K-M	220	50	135	0,60	3,5/400	1400	1850	50	17,00	1	3.440,00
DKF-60/35A-4K-M	220	50	260	1,20	7/400	1350	2800	54	35,00	1	3.700,00
DKF-60/35B-4K-M	220	50	430	1,60	12/400	1380	3400	57	38,00	1	3.920,00
DKF-70/40A-4K-M	220	50	600	2,50	16/400	1340	4500	59	43,00	1	5.920,00
DKF-70/40B-4K-M	220	50	600	2,50	16/400	1340	5900	61	46,00	1	7.110,00
DKF-80/50-4K-T	380	50	1100	2,50	-	1400	7550	64	64,00	1	9.720,00
DKF-100/50-4K-T	380	50	1100	2,50	-	1400	9600	67	92,00	1	11.690,00

Ses seviyesi 3m mesafeden ölçülmüştür. / Sound level has measured at a distance of 3 meters.

# DKFH



## DİKDÖRTGEN KANAL TİPİ HARİCİ MOTORLU RADYAL FANLAR RECTANGULAR IN-LINE RADIAL FANS WITH OUTSOURCED MOTOR

### TEKNİK DEĞERLER / TECHNICAL PARAMETERS

Tip Type	Voltaj Voltage V	Frekans Frequency Hz	Beygir Gücü Horse Power Hp	Güç Power Kw	Devir Speed d/d	Hava Debisi Air Flow m³/h	Ses Seviyesi Sound Pressure Level dB(A)	Ağırlık Weight Kg	Fiyat Price TL
DKFH-315-4K-T	380	50	0,37	0,25	1440	3000	69	34	4.500,00
DKFH-355-4K-T	380	50	0,50	0,37	1420	3500	70	37	4.900,00
DKFH-400-4K-T	380	50	0,75	0,55	1470	4700	73	48	6.650,00
DKFH-450-4K-T	380	50	1,50	1,10	1450	6000	78	53	8.500,00
DKFH-500-4K-T	380	50	2,00	1,50	1400	8400	80	75	11.100,00
DKFH-560-4K-T	380	50	3,00	2,20	1400	10500	81	93	12.200,00

Ses seviyesi 3m mesafeden ölçülmüştür. / Sound level has measured at a distance of 3 meters.

# THC

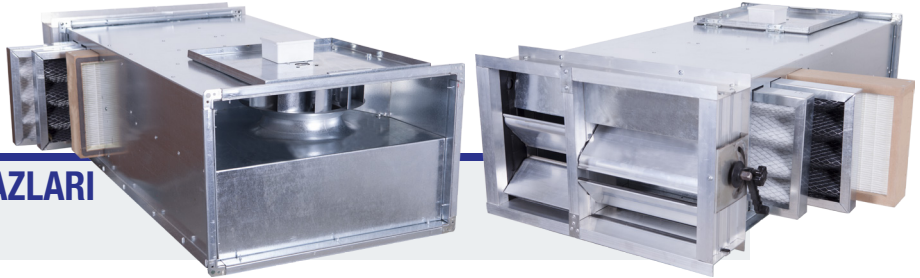

## SIĞINAK TAZE HAVA CİHAZLARI FILTRATION UNIT

### TEKNİK DEĞERLER / TECHNICAL PARAMETERS

Tip Type	Frekans Frequency Hz	Hava Debisi Air Flow m³/h	Basınç Pressure Pa	1. Sıra / Stage Elyaf / Fiber	Filtreler / Filters 2. Sıra / Stage Karbon / Carbon	3. Sıra / Stage Hepa	Fiyat Price TL
THC-450	50	450	200	G4	AC-100	Radyoaktif	10.440,00
THC-750	50	750	200	G4	AC-100	Radyoaktif	11.730,00
THC-1200	50	1200	200	G4	AC-100	Radyoaktif	15.200,00
THC-2000	50	2000	200	G4	AC-100	Radyoaktif	15.620,00
THC-3000	50	3000	200	G4	AC-100	Radyoaktif	19.600,00
THC-4500	50	4500	200	G4	AC-100	Radyoaktif	24.750,00

# HFO



## SIK KANATLI HÜCRELİ FANLAR

### VENTILATION UNIT WITH FORWARD CURVED IMPELLER

TEKNİK DEĞERLER, TEKNİK ÇİZİM, ÖLÇÜLER VE KAPASİTE TABLOSU / TECHNICAL PARAMETERS, DRAWINGS AND DIMENSIONS

Tip Type	Voltaj Voltage V	Frekans Frequency Hz	Beygir Gücü Horse Power Hp	Güç Power Kw	Devir Speed d/d	Hava Debisi Air Flow m³/h	Basınç Pressure Pa	Fiyat Price TL
HFO-07/1-4K-T	380	50	1,00	0,75	1410	2.250	400	6.450,00
HFO-07/2-4K-T	380	50	1,50	1,10	1430	2.800	400	6.600,00
HFO-09/1-4K-T	380	50	1,50	1,10	1430	4.000	350	7.500,00
HFO-09/2-4K-T	380	50	2,00	1,50	1430	5.000	225	7.700,00
HFO-10/1-4K-T	380	50	2,00	1,50	1430	5.500	325	8.500,00
HFO-10/2-4K-T	380	50	3,00	2,20	1435	6.500	325	8.800,00
HFO-12/1-4K-T	380	50	3,00	2,20	1435	7.500	400	9.800,00
HFO-12/2-4K-T	380	50	4,00	3,00	1435	8.500	450	10.300,00
HFO-15/1-4K-T	380	50	4,00	3,00	1435	10.000	450	12.400,00
HFO-15/2-4K-T	380	50	5,50	4,00	1455	12.000	400	13.100,00
HFO-18/1-4K-T	380	50	7,50	5,50	1465	18.000	300	16.300,00
HFO-18/2-4K-T	380	50	10,00	7,50	1465	20.000	375	17.300,00

# HFG



## SEYREK KANATLI HÜCRELİ FANLAR

### VENTILATION UNIT WITH BACKWARD CURVED IMPELLER

TEKNİK DEĞERLER, TEKNİK ÇİZİM, ÖLÇÜLER VE KAPASİTE TABLOSU / TECHNICAL PARAMETERS, DRAWINGS AND DIMENSIONS

Tip Type	Voltaj Voltage V	Frekans Frequency Hz	Beygir Gücü Horse Power Hp	Güç Power Kw	Devir Speed d/d	Hava Debisi Air Flow m³/h	Basınç Pressure Pa	Fiyat Price TL
HFG-250/1-2K-T	380	50	1,50	1,10	2880	4.000	450	10.400,00
HFG-250/2-2K-T	380	50	2,00	1,50	2880	5.000	350	11.200,00
HFG-280/2-2K-T	380	50	2,00	1,50	2880	5.500	400	11.500,00
HFG-280/3-2K-T	380	50	3,00	2,20	2880	6.500	450	12.100,00
HFG-315/3-2K-T	380	50	3,00	2,20	2880	7.500	450	12.800,00
HFG-315/4-2K-T	380	50	4,00	3,00	2880	8.500	500	13.700,00
HFG-355/4-2K-T	380	50	4,00	3,00	2880	10.000	425	14.700,00
HFG-355/5-2K-T	380	50	5,50	4,00	2880	11.500	375	15.900,00
HFG-400/5-2K-T	380	50	5,50	4,00	2880	13.000	400	17.500,00
HFG-400/7-2K-T	380	50	7,50	5,50	2900	14.500	500	19.500,00
HFG-450/7-4K-T	380	50	7,50	5,50	1465	16.000	500	20.600,00
HFG-450/10-4K-T	380	50	10,00	7,50	1465	18.500	600	21.600,00
HFG-500/10-4K-T	380	50	10,00	7,50	1465	21.000	500	23.400,00
HFG-500/15-4K-T	380	50	15,00	11,00	1470	25.000	500	26.400,00

# HTO

## SEYREK KANATLI TEK EMİŐLİ HÜCRELİ FANLAR

### BACKWARD CURVED SINGLE INLET VENTILATION UNIT

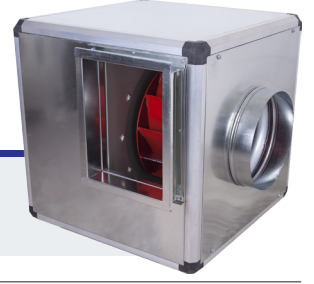

#### TEKNİK DEĞERLER / TECHNICAL PARAMETERS

Tip Type	Voltaj Voltage V	Frekans Frequency Hz	Beygir Gücü Horse Power Hp	Güç Power Kw	Devir Speed d/d	Hava Debisi Air Flow m³/h	Basınç Pressure Pa	Fiyat Price TL
HTO-1-4K-T	380	50	1,00	0,75	1410	2500	400	9.850,00
HTO-2-4K-T	380	50	1,50	1,10	1430	4000	450	10.700,00
HTO-3-4K-T	380	50	2,00	1,50	1430	6000	500	11.020,00
HTO-4-4K-T	380	50	3,00	2,20	1435	8000	550	14.240,00
HTO-5-4K-T	380	50	4,00	3,00	1435	10000	600	16.330,00
HTO-6-4K-T	380	50	5,50	4,00	1455	12000	650	19.870,00
HTO-7-4K-T	380	50	7,50	5,50	1465	16000	700	24.940,00
HTO-8-4K-T	380	50	10,00	7,50	1465	20000	750	28.480,00

# HTF

## SEYREK KANATLI TEK EMİŐLİ KASET FİLTRELİ HÜCRELİ FANLAR

### BACKWARD CURVED SINGLE INLET VENTILATION UNIT WITH FILTER

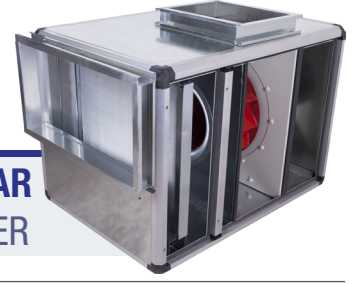

#### TEKNİK DEĞERLER / TECHNICAL PARAMETERS

Tip Type	Voltaj Voltage V	Frekans Frequency Hz	Beygir Gücü Horse Power Hp	Güç Power Kw	Devir Speed d/d	Hava Debisi Air Flow m³/h	Basınç Pressure Pa	Fiyat Price TL
HTF-1-4K-T	380	50	1,00	0,75	1410	2500	300	10.780,00
HTF-2-4K-T	380	50	1,50	1,10	1430	4000	350	11.260,00
HTF-3-4K-T	380	50	2,00	1,50	1430	6000	400	12.230,00
HTF-4-4K-T	380	50	3,00	2,20	1435	8000	450	16.330,00
HTF-5-4K-T	380	50	4,00	3,00	1435	10000	500	18.340,00
HTF-6-4K-T	380	50	5,50	4,00	1455	12000	550	22.530,00
HTF-7-4K-T	380	50	7,50	5,50	1465	16000	600	27.030,00
HTF-8-4K-T	380	50	10,00	7,50	1465	20000	650	29.360,00

# GKC

## TEK EMİŐLİ RADYAL FANLI ÇAPRAZ AKIMLI ISI GERİ KAZANIM CİHAZLARI

### HEAT RECOVERY UNIT WITH RADIAL FAN

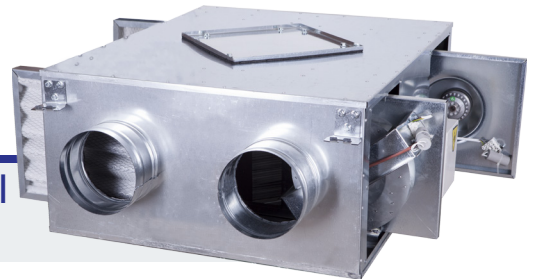

#### TEKNİK DEĞERLER / TECHNICAL PARAMETERS

Tip Type	Voltaj Voltage V	Frekans Frequency Hz	Beygir Gücü Horse Power Hp	Güç Power Kw	Devir Speed d/d	Hava Debisi Air Flow m³/h	Basınç Pressure Pa	Ses Seviyesi Sound Pressure Level dB(A)	Fiyat Price TL
GKC-15-4K-M	230	50	2x0,20	2x0,15	1350	1500	170	60	16.250,00
GKC-25-4K-M	230	50	2x0,50	2x0,37	1350	2500	220	64	18.375,00
GKC-35-4K-M	230	50	2x0,75	2x0,55	1400	3500	230	65	19.062,50
GKC-45-4K-M	230	50	2x0,75	2x0,55	900	4500	200	70	21.812,50

Ses seviyesi 3m mesafeden ölçülmüştür. / Sound level has measured at a distance of 3 meters.

# YÇFH

## HARİCİ MOTORLU RADYAL ÇATI FANLARI

RADIAL ROOF FAN (MOTOR IS OUT OF THE AIR FLOW)

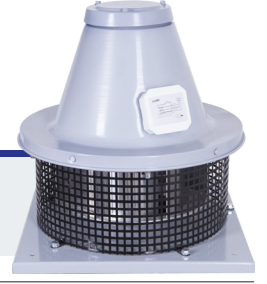

### TEKNİK DEĞERLER / TECHNICAL PARAMETERS

Tip Type	Voltaj Voltage V	Frekans Frequency Hz	Beygir Gücü Horse Power Hp	Güç Power Kw	Devir Speed d/d	Hava Debisi Air Flow m³/h	Ses Seviyesi Sound Pressure Level dB(A)	Ağırlık Weight Kg	Fiyat Price TL
YÇFH-315-2K-M	230	50	0,50	0,37	2800	1800	60	11,30	1.500,00
YÇFH-315-4K-M	230	50	0,50	0,37	1380	1415	57	11,50	1.500,00

# KTI

## ELEKTRİKLİ KANAL TİPİ ISITICI

IN-LINE HEATER

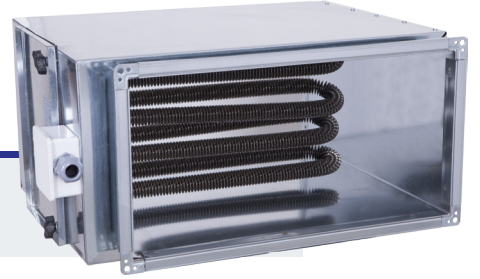

### TEKNİK DEĞERLER / TECHNICAL PARAMETERS

Tip Type	Güç Power Kw	Hava Debisi Air Flow m³/h	Kademe Sayısı Stage Ad.	Fiyat Price TL
KTI-10	3,00	1000	1	3.500,00
KTI-15	5,00	1500	2	3.640,00
KTI-20	7,00	2000	2	4.060,00
KTI-25	8,00	2500	3	4.480,00
KTI-30	10,00	3000	3	4.830,00
KTI-35	12,00	3500	3	5.460,00
KTI-40	13,00	4000	3	5.880,00
KTI-45	15,00	4500	3	6.300,00

# YÇF

## RADYAL ÇATI FANI

RADIAL ROOF FAN



### TEKNİK DEĞERLER / TECHNICAL PARAMETERS

Tip Type	Voltaj Voltage V	Frekans Frequency Hz	Güç Power W	Akım Current A	Kondansatör Capacitor µF/Volt	Devir Speed d/d	Hava Debisi Air Flow m³/h	Ses Seviyesi Sound Pressure Level dB(A)	Ağırlık Weight Kg	Ambalaj Packing Adett	Fiyat Price TL
YÇF-250-2K-M	220	50	170	0,65	5/400	2635	1300	52	8,00	1	1.490,00
YÇF-315-2K-M	220	50	250	1,10	7/400	2660	1800	54	10,00	1	2.580,00
YÇF-355-4K-M	220	50	220	1,20	7/400	1350	2750	59	16,00	1	3.410,00
YÇF-400-4K-M	220	50	560	1,60	12/400	1380	3620	61	29,00	1	6.010,00
YÇF-450-4K-M	220	50	830	2,50	16/400	1340	5900	62	37,00	1	7.650,00
YÇF-500-4K-T	380	50	1560	2,50	-	1400	8000	65	51,00	1	9.730,00
YÇF-560-4K-T	380	50	1800	2,50	-	1400	10000	66	62,00	1	10.950,00

Ses seviyesi 3m mesafeden ölçülmüştür. / Sound level has measured at a distance of 3 meters.

# DPA & LPA

**DEKORATİF ve LÜKS PLASTİK  
ASPIRATÖRLER**  
DECORATIVE & LUX PLASTIC  
AXIAL FANS



DPA



LPA

## TEKNİK TABLO / TECHNICAL PARAMETERS

Tip Type	Voltaj Voltage V	Frekans Frequency Hz	Güç Power W	Devir Speed d/d	Hava Debisi Air Flow m³/h	Ses Seviyesi Sound Pressure Level dB(A)	Ağırlık Weight Kg	Ambalaj Packing Adet	Fiyat Price TL
DPA-100-2K-M	220	50	15	2600	100	39	0,36	12-24	<b>110,00</b>
DPA-120-2K-M	220	50	20	2600	200	41	0,39	12-24	<b>117,00</b>
DPA-150-2K-M	220	50	25	2450	320	43	0,50	12-24	<b>138,00</b>

Ses seviyesi 3m mesafeden ölçülmüştür. / Sound level has measured at a distance of 3 meters.

Tip Type	Voltaj Voltage V	Frekans Frequency Hz	Güç Power W	Devir Speed d/d	Hava Debisi Air Flow m³/h	Ses Seviyesi Sound Pressure Level dB(A)	Ağırlık Weight Kg	Ambalaj Packing Adet	Fiyat Price TL
LPA-100-2K-M	220	50	15	2600	100	39	0,36	12-24	<b>110,00</b>
LPA-120-2K-M	220	50	20	2600	200	41	0,39	12-24	<b>117,00</b>
LPA-150-2K-M	220	50	25	2450	320	43	0,50	12-24	<b>138,00</b>

Ses seviyesi 3m mesafeden ölçülmüştür. / Sound level has measured at a distance of 3 meters.

# KTA & BTA

**KAPAKLI ve BACA TİPİ  
ASPIRATÖRLER**  
AXIAL FANS  
WITH LID & CHIMNEY



KTA



BTA

## TEKNİK TABLO / TECHNICAL PARAMETERS

Tip Type	Voltaj Voltage V	Frekans Frequency Hz	Güç Power W	Akım Current A	Devir Speed d/d	Hava Debisi Air Flow m³/h	Ses Seviyesi Sound Pressure Level dB(A)	Ağırlık Weight Kg	Ambalaj Packing Adet	Fiyat Price TL
KTA-160-4K-M	220	50	40	0,25	1400	390	44	1,67	8	<b>285,00</b>
KTA-200-4K-M	220	50	50	0,25	1400	650	48	1,95	8	<b>300,00</b>
KTA-250-4K-M	220	50	50	0,29	1400	900	49	2,45	8	<b>390,00</b>

Ses seviyesi 3m mesafeden ölçülmüştür. / Sound level has measured at a distance of 3 meters.

Tip Type	Voltaj Voltage V	Frekans Frequency Hz	Güç Power W	Akım Current A	Devir Speed d/d	Hava Debisi Air Flow m³/h	Ses Seviyesi Sound Pressure Level dB(A)	Ağırlık Weight Kg	Ambalaj Packing Adet	Fiyat Price TL
BTA-160-4K-M	220	50	40	0,25	1400	390	44	1,50	8	<b>265,00</b>
BTA-200-4K-M	220	50	50	0,25	1400	650	48	1,60	8	<b>295,00</b>
BTA-250-4K-M	220	50	50	0,29	1400	900	49	1,80	8	<b>385,00</b>

Ses seviyesi 3m mesafeden ölçülmüştür. / Sound level has measured at a distance of 3 meters.

# DRAF

## AKSİYEL FANLAR AXIAL FANS



### TEKNİK TABLO / TECHNICAL PARAMETERS

Tip Type	Voltaj Voltage V	Frekans Frequency Hz	Güç Power W	Akım Current A	Kondansatör Capacitor (µF/Volt)	Devir Speed d/d	Hava Debisi Air Flow m³/h	Ses Seviyesi Sound Pressure Level dB(A)	Ağırlık Weight Kg	Ambalaj Packing Adet	Fiyat Price TL
DRAF-200-2K-M	220	50	80	0,35	2,5/400	2700	765	59	2,30	1	<b>415,00</b>
DRAF-250-2K-M	220	50	110	0,49	2,5/400	2650	1750	69	2,90	1	<b>485,00</b>
DRAF-300-2K-M	220	50	170	0,78	4/400	2450	2350	70	3,60	1	<b>560,00</b>
DRAF-350-2K-M	220	50	260	1,10	6/400	2400	3700	75	4,35	1	<b>655,00</b>

Ses seviyesi 3m mesafeden ölçülmüştür. / Sound level has measured at a distance of 3 meters.

# YSA

## YUVARLAK KASALI SANAYİ TİPİ ASPİRATÖRLER CIRCULAR PLATE INDUSTRIAL FANS

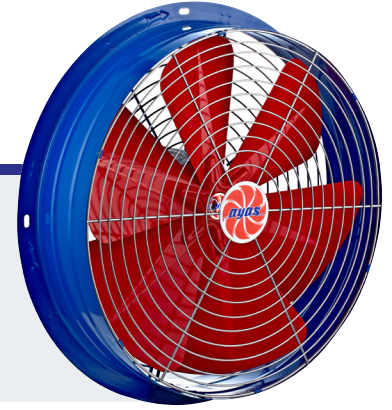

### TEKNİK TABLO / TECHNICAL PARAMETERS

Tip Type	Voltaj Voltage V	Frekans Frequency Hz	Güç Power W	Akım Current A	Kondansatör Capacitor (µF/Volt)	Devir Speed d/d	Hava Debisi Air Flow m³/h	Ses Seviyesi Sound Pressure Level dB(A)	Ağırlık Weight Kg	Ambalaj Packing Adet	Fiyat Price TL
YSA-250-2K-M	220	50	180	1,20	5/400	2800	2250	66	7,58	2	<b>800,00</b>
YSA-250-2K-T	380	50	165	1,00	5/400	2800	2300	66	6,98	2	<b>800,00</b>
YSA-250-4K-M	220	50	120	0,26	2,5/400	1400	1400	53	6,45	2	<b>770,00</b>
YSA-250-4K-T	380	50	110	0,21	2,5/400	1400	1400	53	6,70	2	<b>770,00</b>
YSA-300-2K-M	220	50	215	1,54	5/400	2800	4850	70	7,70	2	<b>850,00</b>
YSA-300-2K-T	380	50	135	0,57	5/400	2800	5100	70	6,20	2	<b>850,00</b>
YSA-300-4K-M	220	50	130	0,34	2,5/400	1400	2200	53	7,10	2	<b>820,00</b>
YSA-300-4K-T	380	50	125	0,25	2,5/400	1400	2200	53	6,45	2	<b>820,00</b>
YSA-350-4K-M	220	50	160	0,42	4/400	1400	3350	56	7,90	2	<b>850,00</b>
YSA-350-4K-T	380	50	140	0,30	4/400	1400	3350	56	7,15	2	<b>850,00</b>
YSA-400-4K-M	220	50	200	0,54	5/400	1400	4550	58	9,10	2	<b>920,00</b>
YSA-400-4K-T	380	50	180	0,40	5/400	1400	4800	58	9,10	2	<b>920,00</b>
YSA-450-4K-M	220	50	220	0,62	6/400	1400	5300	59	9,60	2	<b>975,00</b>
YSA-450-4K-T	380	50	210	0,44	6/400	1400	5500	59	9,95	2	<b>975,00</b>
YSA-500-4K-M	220	50	230	0,74	7/400	1400	6900	63	11,15	1	<b>1.060,00</b>
YSA-500-4K-T	380	50	220	0,50	7/400	1400	7400	63	13,00	1	<b>1.060,00</b>
YSA-550-4K-M	220	50	400	1,10	8/400	1400	7200	64	13,00	1	<b>1.290,00</b>
YSA-550-4K-T	380	50	300	0,80	8/400	1400	7900	64	13,25	1	<b>1.290,00</b>
YSA-600-4K-M	220	50	560	1,35	10/400	1400	8500	66	15,20	1	<b>1.300,00</b>
YSA-600-4K-T	380	50	450	0,95	10/400	1400	8700	66	15,45	1	<b>1.300,00</b>

Ses seviyesi 3m mesafeden ölçülmüştür. / Sound level has measured at a distance of 3 meters.

# KSA

## KARE KASALI SANAYİ TİPİ ASPİRATÖRLER SQUARE PLATE INDUSTRIAL FANS



### TEKNİK TABLO / TECHNICAL PARAMETERS

Tip Type	Voltaj Voltage V	Frekans Frequency Hz	Güç Power W	Akım Current A	Kondansatör Capacitor (µF/Volt)	Devir Speed d/d	Hava Debisi Air Flow m³/h	Ses Seviyesi Sound Pressure Level dB(A)	Ağırlık Weight Kg	Ambalaj Packing Adet	Kare Kasa Ölçüsü Square Plate Size mm	Fiyat Price TL
KSA-250-2K-M	220	50	180	1,20	5/400	2800	2250	66	7,58	2	350x350	870,00
KSA-250-2K-T	380		165	1,00			2300		6,98			
KSA-250-4K-M	220	50	120	0,26	2,5/400	1400	1400	53	7,13	2	350x350	825,00
KSA-250-4K-T	380		110	0,21			1400		7,28			
KSA-300-2K-M	220	50	215	1,54	5/400	2800	4850	70	8,50	2	400x400	905,00
KSA-300-2K-T	380		135	0,57			5100		6,88			
KSA-300-4K-M	220	50	130	0,34	2,5/400	1400	2200	53	7,78	2	400x400	870,00
KSA-300-4K-T	380		125	0,25			2200		7,13			
KSA-350-4K-M	220	50	160	0,42	4/400	1400	3350	56	8,70	2	450x450	965,00
KSA-350-4K-T	380		140	0,30			3350		7,95			
KSA-400-4K-M	220	50	200	0,54	5/400	1400	4550	58	10,00	2	500x500	990,00
KSA-400-4K-T	380		180	0,40			4800		10,00			
KSA-450-4K-M	220	50	220	0,62	6/400	1400	5300	59	10,80	2	550x550	1.060,00
KSA-450-4K-T	380		210	0,44			5500		11,15			
KSA-500-4K-M	220	50	230	0,74	7/400	1400	6900	63	12,50	1	600x600	1.250,00
KSA-500-4K-T	380		220	0,50			7400		12,70			
KSA-550-4K-M	220	50	400	1,10	8/400	1400	7200	64	14,72	1	650x650	1.490,00
KSA-550-4K-T	380		300	0,80			7900		14,95			
KSA-600-4K-M	220	50	560	1,35	10/400	1400	8500	66	17,37	1	720x720	1.600,00
KSA-600-4K-T	380		450	0,95			8700		17,70			

Ses seviyesi 3m mesafeden ölçülmüştür. / Sound level has measured at a distance of 3 meters.

# 7KA

## 7 KANATLI HARİCİ MOTORLU SANAYİ TİPİ AKSİYEL ASPİRATÖRLER 7 BLADES INDUSTRIAL TYPE AXIAL FANS

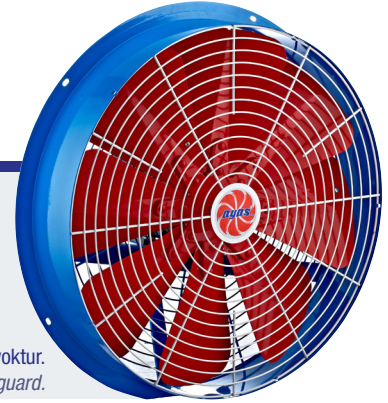

7KA-800-4K-M/T 'lerde ön tel yoktur.  
7KA-800-4K-M/T has not equipped with front guard.

### TEKNİK TABLO / TECHNICAL PARAMETERS

Tip Type	Voltaj Voltage V	Frekans Frequency Hz	Güç Power Kw	Devir Speed d/d	Hava Debisi Air Flow m³/h	Fiyat Price	
						Monofaze TL Trifaze TL	
7KA-300-4K-M	7KA-300-4K-T	220 / 380	50	0,25	1350	2500	2.002,00 1.768,00
7KA-350-4K-M	7KA-350-4K-T	220 / 380	50	0,25	1350	3000	2.054,00 1.752,00
7KA-400-4K-M	7KA-400-4K-T	220 / 380	50	0,25	1350	3500	2.314,00 1.924,00
7KA-450-4K-M	7KA-450-4K-T	220 / 380	50	0,37	1380	4000	2.535,00 2.145,00
7KA-500-4K-M	7KA-500-4K-T	220 / 380	50	0,37	1380	6000	2.990,00 2.613,00
7KA-600-4K-M	7KA-600-4K-T	220 / 380	50	0,75	1410	9500	3.653,00 3.315,00
7KA-700-4K-M	7KA-700-4K-T	220 / 380	50	1,5	1430	12000	6.344,00 5.863,00
7KA-800-4K-M	7KA-800-4K-T	220 / 380	50	3	1435	18000	9.139,00 8.515,00



# 4KA

## 4 KANATLI HARİCİ MOTORLU SANAYİ TİPİ AKSİYEL ASPİRATÖRLER

### 4 BLADES INDUSTRIAL TYPE AXIAL FANS

4KA-800-4K-T / 4KA-900-4K-T / 4KA-1000-4K-T 'lerde ön tel yoktur.  
4KA-800-4K-T / 4KA-900-4K-T / 4KA-1000-4K-T has not equipped with front guard.

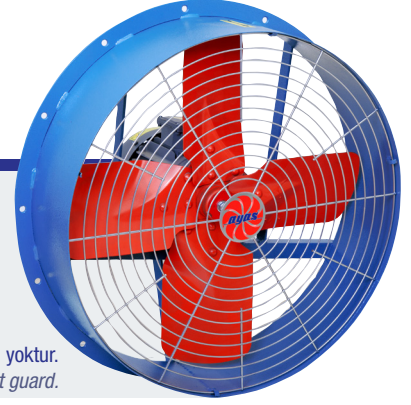

#### TEKNİK TABLO / TECHNICAL PARAMETERS

Tip Type	Voltaj Voltage V	Frekans Frequency Hz	Güç Power Kw	Devir Speed d/d	Hava Debisi Air Flow m³/h	Fiyat Price		
						Monofaze TL	Trifaze TL	
4KA-300-4K-M	4KA-300-4K-T	220 / 380	50	0,37	1400	3500	2.340,00	2.164,50
4KA-350-4K-M	4KA-350-4K-T	220 / 380	50	0,37	1400	4000	2.541,50	2.340,00
4KA-400-4K-M	4KA-400-4K-T	220 / 380	50	0,37	1400	5000	2.730,00	2.587,00
4KA-450-4K-M	4KA-450-4K-T	220 / 380	50	0,37	1400	6000	3.009,50	2.691,00
4KA-500-4K-M	4KA-500-4K-T	220 / 380	50	0,75	1400	8000	3.536,00	3.250,00
4KA-550-4K-M	4KA-550-4K-T	220 / 380	50	0,75	1400	10000	3.653,00	3.393,00
4KA-600-4K-M	4KA-600-4K-T	220 / 380	50	1,1	1400	12000	4.030,00	3.718,00
4KA-650-4K-M	4KA-650-4K-T	220 / 380	50	1,5	1400	14000	4.784,00	4.602,00
4KA-700-4K-M	4KA-700-4K-T	220 / 380	50	2,2	1400	16000	5.668,00	5.304,00
	4KA-800-4K-T	380	50	4	1400	25000	-	7.878,00
	4KA-900-4K-T	380	50	5,5	1400	35000	-	10.023,00
	4KA-1000-4K-T	380	50	5,5	1400	40000	-	11.154,00

# KMP

## KOVANLI HARİCİ MOTORLU SANAYİ TİPİ ASPİRATÖRLER TUBE FANS



#### TEKNİK TABLO / TECHNICAL PARAMETERS

Tip Type	Voltaj Voltage V	Frekans Frequency Hz	Beygir Gücü Horse Power Hp	Güç Power Kw	Devir Speed d/d	Hava Debisi Air Flow m³/h	Fiyat Price		
							Monofaze TL	Trifaze TL	
KMP-300-4K-M	KMP-300-4K-T	220 / 380	50	0,50	0,37	1380	3500	2.925,00	2.730,00
KMP-350-4K-M	KMP-350-4K-T	220 / 380	50	0,50	0,37	1380	4000	3.146,00	3.029,00
KMP-400-4K-M	KMP-400-4K-T	220 / 380	50	0,50	0,37	1380	5000	3.497,00	3.250,00
KMP-450-4K-M	KMP-450-4K-T	220 / 380	50	0,50	0,37	1380	6000	3.757,00	3.536,00
KMP-500-4K-M	KMP-500-4K-T	220 / 380	50	1,00	0,75	1410	8000	4.537,00	4.316,00
KMP-560-4K-M	KMP-560-4K-T	220 / 380	50	1,00	0,75	1410	10000	4.888,00	4.641,00
KMP-630-4K-M	KMP-630-4K-T	220 / 380	50	2,00	1,50	1430	14000	6.045,00	5.824,00
KMP-710-4K-M	KMP-710-4K-T	220 / 380	50	3,00	2,20	1435	16000	6.968,00	6.760,00
KMP-800-4K-T		380	50	5,50	4,00	1455	25000	-	7.631,00
KMP-900-4K-T		380	50	7,50	5,50	1465	35000	-	9.750,00
KMP-1000-6K-T		380	50	7,50	5,50	960	40000	-	11.173,00
KMP-1100-6K-T		380	50	7,50	5,50	960	45000	-	15.158,00
KMP-1200-6K-T		380	50	10,00	7,50	960	50000	-	19.045,00

# KAP

## KOVANLI HARİCİ MOTORLU ALÜMİNYUM PERVANELİ SANAYİ TİPİ ASPIRATÖRLER TUBE FANS ALUMINUM IMPELLER



TEKNİK TABLO / TECHNICAL PARAMETERS

Tip Type	Voltaj Voltage V	Frekans Frequency Hz	Beygir Gücü Horse Power Hp	Güç Power Kw	Devir Speed d/d	Hava Debisi Air Flow m³/h	Fiyat Price		
							Monofaze TL	Trifaze TL	
KAP-300-4K-M	KAP-300-4K-T	220 / 380	50	0,50	0,37	1380	2900	3.835,00	3.601,00
KAP-350-4K-M	KAP-350-4K-T	220 / 380	50	0,50	0,37	1380	5300	4.082,00	3.822,00
KAP-400-4K-M	KAP-400-4K-T	220 / 380	50	0,75	0,55	1380	5880	4.420,00	4.082,00
KAP-450-4K-M	KAP-450-4K-T	220 / 380	50	0,75	0,55	1380	7800	4.901,00	4.420,00
KAP-500-4K-M	KAP-500-4K-T	220 / 380	50	1,00	0,75	1410	9110	5.109,00	4.901,00
KAP-560-4K-M	KAP-560-4K-T	220 / 380	50	1,50	1,10	1410	12350	6.032,00	5.811,00
KAP-630-4K-M	KAP-630-4K-T	220 / 380	50	2,00	1,50	1430	12900	6.318,00	6.032,00
KAP-710-4K-T		380	50	4,00	3,00	1435	28000	-	7.436,00
KAP-800-4K-T		380	50	7,50	5,50	1455	36500	-	9.672,00
KAP-900-4K-T		380	50	10,00	7,50	1465	42000	-	11.505,00
KAP-1000-6K-T		380	50	15,00	11,00	960	57000	-	15.041,00
KAP-1100-6K-T		380	50	20,00	15,00	960	77000	-	18.135,00
KAP-1200-6K-T		380	50	25,00	18,50	960	82000	-	22.100,00

# KPP

## KOVANLI HARİCİ MOTORLU PLASTİK PERVANELİ SANAYİ TİPİ ASPIRATÖRLER TUBE FANS PLASTIC IMPELLER



TEKNİK TABLO / TECHNICAL PARAMETERS

Tip Type	Voltaj Voltage V	Frekans Frequency Hz	Beygir Gücü Horse Power Hp	Güç Power Kw	Devir Speed d/d	Hava Debisi Air Flow m³/h	Fiyat Price		
							Monofaze TL	Trifaze TL	
KPP-300-4K-M	KPP-300-4K-T	220 / 380	50	0,50	0,37	1390	2900	3.406,00	3.159,00
KPP-350-4K-M	KPP-350-4K-T	220 / 380	50	0,50	0,37	1390	5300	3.900,00	3.653,00
KPP-400-4K-M	KPP-400-4K-T	220 / 380	50	0,75	0,55	1365	5880	4.511,00	4.147,00
KPP-450-4K-M	KPP-450-4K-T	220 / 380	50	0,75	0,55	1365	7800	4.758,00	4.381,00
KPP-500-4K-M	KPP-500-4K-T	220 / 380	50	1,00	0,75	1410	9110	5.356,00	5.109,00
KPP-560-4K-M	KPP-560-4K-T	220 / 380	50	1,50	1,10	1420	12350	5.980,00	5.603,00
KPP-630-4K-M	KPP-630-4K-T	220 / 380	50	2,00	1,50	1430	12900	6.812,00	6.552,00
KPP-710-4K-M	KPP-710-4K-T	220 / 380	50	4,00	3,00	1435	28000	7.683,00	7.306,00
KPP-800-4K-T		380	50	7,50	5,50	1465	36500	-	8.515,00
KPP-900-4K-T		380	50	10,00	7,50	1465	42000	-	9.737,00
KPP-1000-4K-T		380	50	15,00	11,00	1465	57000	-	14.586,00
KPP-1100-4K-T		380	50	20,00	15,00	1465	77000	-	19.461,00
KPP-1200-4K-T		380	50	25,00	18,50	1470	82000	-	24.323,00

# SGF

## SAC GÖVDELİ RADYAL FANLAR SHEET METAL CASING CENTRIFUGAL FANS



### TEKNİK DEĞERLER / TECHNICAL PARAMETERS

Tip Type	Voltaj Voltage V	Frekans Frequency Hz	Güç Power W	Akım Current A	Kondansatör Capacitor (µF/Volt)	Devir Speed d/d	Hava Debisi Air Flow m³/h	Ses Seviyesi Sound Pressure Level dB(A)	Ağırlık Weight Kg	Ambalaj Packing Adet	Fiyat Price TL
SGF-120E-2K-M	220	50	100	0,43	2,5/400	2450	450	62	2,28	1	<b>410,00</b>
SGF-140E-2K-M	220	50	140	0,43	2,5/400	2400	650	65	2,65	1	<b>470,00</b>
SGF-140ER-2K-M	220	50	180	0,63	2,5/400	2620	800	68	2,86	1	<b>480,00</b>
SGF-160E-2K-M	220	50	180	0,63	4/400	2620	950	69	3,45	1	<b>545,00</b>
SGF-160ER-2K-M	220	50	180	0,80	4/400	2485	1150	71	3,50	1	<b>560,00</b>

Ses seviyesi 3m mesafeden ölçülmüştür. / Sound level has measured at a distance of 3 meters.

# AGF

## ALÜMİNYUM GÖVDELİ RADYAL FANLAR ALUMINUM CASING CENTRIFUGAL FANS



### TEKNİK DEĞERLER / TECHNICAL PARAMETERS

Tip Type	Voltaj Voltage V	Frekans Frequency Hz	Güç Power W	Akım Current A	Kondansatör Capacitor (µF/Volt)	Devir Speed d/d	Hava Debisi Air Flow m³/h	Ses Seviyesi Sound Pressure Level dB(A)	Ağırlık Weight Kg	Ambalaj Packing Adet	Fiyat Price TL
AGF-120E-2K-M	220	50	90	0,40	2,5/400	2450	395	60	2,45	1	<b>425,00</b>
AGF-140E-2K-M	220	50	130	0,53	2,5/400	2410	550	67	2,57	1	<b>475,00</b>
AGF-140ER-2K-M	220	50	165	0,60	2,5/400	2390	660	69	2,98	1	<b>490,00</b>
AGF-160E-2K-M	220	50	173	0,80	4/400	2320	730	72	3,63	1	<b>555,00</b>
AGF-160ER-2K-M	220	50	185	0,85	4/400	2285	850	74	3,82	1	<b>580,00</b>

Ses seviyesi 3m mesafeden ölçülmüştür. / Sound level has measured at a distance of 3 meters.

# OBRS

## TEK EMİŞLİ SEYREK ALM. DÖKÜM KANATLI RADYAL FANLAR SINGLE INLET CENTRIFUGAL FANS WITH ALUMINUM IMPELLER

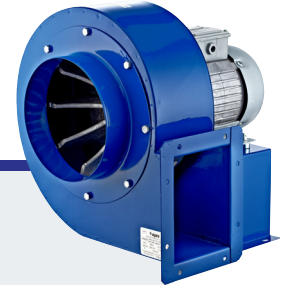

### TEKNİK DEĞERLER / TECHNICAL PARAMETERS

Tip Type	Voltaj Voltage V	Frekans Frequency Hz	Güç Power W	Akım Current A	Kondansatör Capacitor (µF/Volt)	Devir Speed d/d	Hava Debisi Air Flow m³/h	Ağırlık Weight Kg	Ambalaj Packing Adet	Fiyat Price TL
OBRS-140-2K-M	220	50	195	0,84	6/400	2800	800	8,20	2	<b>990,00</b>
OBRS-140-2K-T	380	50	170	0,79	-	2800	920	8,10	2	<b>990,00</b>
OBRS-200-2K-M	220	50	260	1,12	9/400	2800	1050	9,40	2	<b>1.010,00</b>
OBRS-200-2K-T	380	50	240	1,00	-	2800	1220	9,20	2	<b>1.010,00</b>
OBRS-260-2K-M	220	50	620	2,87	10/400	2800	1800	10,55	1	<b>1.190,00</b>
OBRS-260-2K-T	380	50	600	2,55	-	2800	2050	10,35	1	<b>1.190,00</b>

# OBRA-140



## TEK EMİŞLİ RADYAL FANLAR SINGLE INLET CENTRIFUGAL FANS

### TEKNİK DEĞERLER / TECHNICAL PARAMETERS

Tip Type	Voltaj Voltage V	Frekans Frequency Hz	Güç Power W	Akım Current A	Kondansatör Capacitor (µF/Volt)	Devir Speed d/d	Hava Debisi Air Flow m³/h	Ses Seviyesi Sound Pressure Level dB(A)	Ağırlık Weight Kg	Ambalaj Packing Adet	Fiyat Price TL
OBRA-140-2K-M	220	50	370	2,60	5/400	2800	1350	50	8,00	2	915,00
OBRA-140-4K-M	220	50	300	2,00	4/400	1400	600	43	7,90	2	915,00
OBRA-140-2K-T	380	50	370	3,00	-	2800	1500	52	7,95	2	915,00
OBRA-140-4K-T	380	50	250	1,20	-	1400	650	45	7,85	2	915,00

Ses seviyesi 3m mesafeden ölçülmüştür. / Sound level has measured at a distance of 3 meters.

# OBRA-200

SAĞ YÖN / RIGHT OUTLET

SOL YÖN / LEFT OUTLET

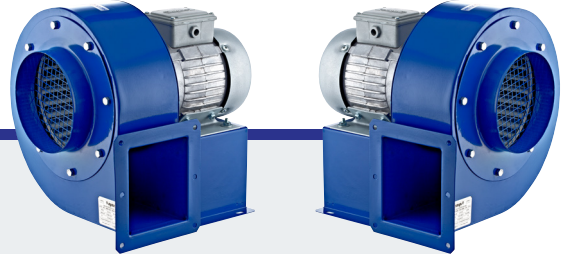

## TEK EMİŞLİ RADYAL FANLAR SINGLE INLET CENTRIFUGAL FANS

### TEKNİK DEĞERLER / TECHNICAL PARAMETERS

Tip Type	Voltaj Voltage V	Frekans Frequency Hz	Güç Power W	Akım Current A	Kondansatör Capacitor (µF/Volt)	Devir Speed d/d	Hava Debisi Air Flow m³/h	Ses Seviyesi Sound Pressure Level dB(A)	Ağırlık Weight Kg	Ambalaj Packing Adet	Fiyat Price TL
OBRA-200-2K-M	220	50	370	2,60	5/400	2800	1850	53	9,15	2	970,00
OBRA-200-4K-M	220	50	300	2,00	4/400	1400	950	45	9,00	2	970,00
OBRA-200-2K-T	380	50	370	3,00	-	2800	2150	53	9,10	2	970,00
OBRA-200-4K-T	380	50	250	1,20	-	1400	1050	46	8,90	2	970,00

Ses seviyesi 3m mesafeden ölçülmüştür. / Sound level has measured at a distance of 3 meters.

# OBRA-260

SAĞ YÖN / RIGHT OUTLET

SOL YÖN / LEFT OUTLET

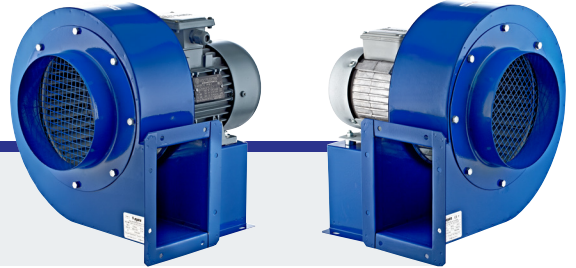

## TEK EMİŞLİ RADYAL FANLAR SINGLE INLET CENTRIFUGAL FANS

### TEKNİK DEĞERLER / TECHNICAL PARAMETERS

Tip Type	Voltaj Voltage V	Frekans Frequency Hz	Güç Power W	Akım Current A	Kondansatör Capacitor (µF/Volt)	Devir Speed d/d	Hava Debisi Air Flow m³/h	Ses Seviyesi Sound Pressure Level dB(A)	Ağırlık Weight Kg	Ambalaj Packing Adet	Fiyat Price TL
OBRA-260-4K-M	220	50	350	1,20	7/400	1400	1300	50	10,25	1	1.130,00
OBRA-260-4K-T	380	50	220	1,40	-	1400	1350	46	10,15	1	1.130,00
OBRA-260-2K-M	220	50	750	5,20	30/500	2800	2500	53	13,95	1	2.750,00
OBRA-260-2K-T	380	50	750	2,50	-	2800	2650	55	12,60	1	2.250,00

Ses seviyesi 3m mesafeden ölçülmüştür. / Sound level has measured at a distance of 3 meters.

Yön çizelgesi en arka sayfadadır / The rotations of outlet are shown on the back page

# ABS

## ALÇAK BASINÇLI RADYAL FANLAR LOW PRESSURE CENTRIFUGAL FANS



### TEKNİK DEĞERLER / TECHNICAL PARAMETERS

Tip Type	Voltaj Voltage V	Frekans Frequency Hz	Güç Power Kw	Devir Speed d/d	Hava Debisi Air Flow m³/h	Basınç Pressure Pa	Fiyat Price		
							Monofaze TL	Trifaze TL	
ABS-1-4K-M	ABS-1-4K-T	220 / 380	50	0,37	1400	1500	400	3.195,00	3.995,00
ABS-2-4K-M	ABS-2-4K-T	220 / 380	50	0,75	1400	2500	450	4.070,00	3.760,00
ABS-3-4K-M	ABS-3-4K-T	220 / 380	50	1,1	1400	3500	600	4.490,00	4.375,00
ABS-4-4K-M	ABS-4-4K-T	220 / 380	50	1,5	1400	4500	700	5.220,00	4.870,00
ABS-5-4K-M	ABS-5-4K-T	220 / 380	50	2,2	1400	6000	750	6.110,00	5.920,00
ABS-6-4K-M	ABS-6-4K-T	220 / 380	50	3	1400	6500	800	6.850,00	6.370,00
	ABS-7-4K-T	380	50	4	1400	7000	950	-	7.600,00
	ABS-8-4K-T	380	50	5,5	1400	9000	1200	-	9.560,00
	ABS-9-4K-T	380	50	7,5	1400	12000	1500	-	11.250,00

Yön çizelgesi en arka sayfadadır / The rotations of outlet are shown on the back page

# OBS

## ORTA BASINÇLI RADYAL FANLAR MEDIUM PRESSURE CENTRIFUGAL FANS



### TEKNİK DEĞERLER / TECHNICAL PARAMETERS

Tip Type	Voltaj Voltage V	Frekans Frequency Hz	Güç Power Kw	Devir Speed d/d	Hava Debisi Air Flow m³/h	Basınç Pressure Pa	Fiyat Price		
							Monofaze TL	Trifaze TL	
OBS-1-2K-M	OBS-1-2K-T	220 / 380	50	0,37	2800	950	130	3.195,00	3.995,00
OBS-2-2K-M	OBS-2-2K-T	220 / 380	50	0,75	2800	1000	200	4.070,00	3.760,00
OBS-3-2K-M	OBS-3-2K-T	220 / 380	50	1,1	2800	1300	300	4.490,00	4.375,00
OBS-4-2K-M	OBS-4-2K-T	220 / 380	50	1,5	2800	1600	350	5.220,00	4.870,00
OBS-5-2K-M	OBS-5-2K-T	220 / 380	50	2,2	2800	1900	400	6.110,00	5.920,00
OBS-6-2K-M	OBS-6-2K-T	220 / 380	50	3	2800	2200	450	6.580,00	6.370,00
	OBS-7-2K-T	380	50	4	2800	2500	500	-	7.600,00
	OBS-8-2K-T	380	50	5,5	2800	3000	600	-	9.560,00
	OBS-9-2K-T	380	50	7,5	2800	4000	725	-	11.250,00

Yön çizelgesi en arka sayfadadır / The rotations of outlet are shown on the back page

# YBS

## YÜKSEK BASINÇLI RADYAL FANLAR HIGH PRESSURE CENTRIFUGAL FANS



### TEKNİK DEĞERLER / TECHNICAL PARAMETERS

Tip Type	Voltaj Voltage V	Frekans Frequency Hz	Güç Power Kw	Devir Speed d/d	Hava Debisi Air Flow m³/h	Basınç Pressure Pa	Fiyat Price		
							Monofaze TL	Trifaze TL	
YBS-1-2K-M	YBS-1-2K-T	220 / 380	50	0,37	2800	350	250	3.195,00	3.995,00
YBS-2-2K-M	YBS-2-2K-T	220 / 380	50	0,75	2800	400	300	4.070,00	3.760,00
YBS-3-2K-M	YBS-3-2K-T	220 / 380	50	1,1	2800	450	400	4.490,00	4.375,00
YBS-4-2K-M	YBS-4-2K-T	220 / 380	50	1,5	2800	500	450	5.220,00	4.870,00
YBS-5-2K-M	YBS-5-2K-T	220 / 380	50	2,2	2800	600	500	6.110,00	5.920,00
YBS-6-2K-M	YBS-6-2K-T	220 / 380	50	3	2800	1000	700	6.580,00	6.370,00
	YBS-7-2K-T	380	50	4	2800	1200	800	-	7.600,00
	YBS-8-2K-T	380	50	5,5	2800	1300	900	-	9.560,00
	YBS-9-2K-T	380	50	7,5	2800	1500	1000	-	11.250,00

Yön çizelgesi en arka sayfadadır / The rotations of outlet are shown on the back page

# KABS

## KARE GÖVDELİ ALÇAK BASINÇLI RADYAL FANLAR SQUARE CASING LOW PRESSURE RADIAL FANS

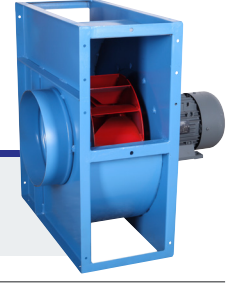

### TEKNİK DEĞERLER / TECHNICAL PARAMETERS

Tip Type	Voltaj Voltage V	Frekans Frequency Hz	Beygir Gücü Horse Power Hp	Güç Power Kw	Devir Speed d/d	Hava Debisi Air Flow m³/h	Basınç Pressure Pa	Fiyat Price		
								Monofaze TL	Trifaze TL	
KABS-1-4K-M	KABS-1-4K-T	220/380	50	0,50	0,37	1380	2000	400	3.450,00	3.220,00
KABS-2-4K-M	KABS-2-4K-T	220/380	50	1,00	0,75	1410	3000	500	4.380,00	4.050,00
KABS-3-4K-M	KABS-3-4K-T	220/380	50	1,50	1,10	1430	4000	600	4.830,00	4.710,00
KABS-4-4K-M	KABS-4-4K-T	220/380	50	2,00	1,50	1430	5000	700	5.620,00	5.240,00
KABS-5-4K-M	KABS-5-4K-T	220/380	50	3,00	2,20	1435	6500	800	6.570,00	6.360,00
KABS-6-4K-M	KABS-6-4K-T	220/380	50	4,00	3,00	1435	7500	900	7.080,00	6.850,00
	KABS-7-4K-T	380	50	5,50	4,00	1455	8500	1000	-	8.170,00
	KABS-8-4K-T	380	50	7,50	5,50	1465	10500	1100	-	10.290,00
	KABS-9-4K-T	380	50	10,00	7,50	1465	12500	1200	-	12.100,00

# ÇES-OÇES

## ÇİFT EMİŞLİ RADYAL FANLAR DOUBLE INLET CENTRIFUGAL FANS



### TEKNİK DEĞERLER / TECHNICAL PARAMETERS

Tip Type	Voltaj Voltage V	Frekans Frequency Hz	Güç Power W	Akım Current A	Kondansatör Capacitor (µF/Volt)	Devir Speed d/d	Hava Debisi Air Flow m³/h	Ses Seviyesi Sound Pressure Level dB(A)	Ağırlık Weight Kg	Ambalaj Packing Adet	Fiyat Price TL
ÇES-185-4K-M	220	50	300	2,00	7/400	1400	1350	44	9,00	2	1.020,00
OÇES-215-4K-M	220	50	400	2,20	9/400	1400	1950	46	9,80	2	1.060,00

Ses seviyesi 3m mesafeden ölçülmüştür. / Sound level has measured at a distance of 3 meters.

# KKRF

## KAYIŞ KASNAK TAHRİKLİ ALÇAK BASINÇLI RADYAL FANLAR BELT-DRIVEN LOW PRESSURE RADIAL FANS

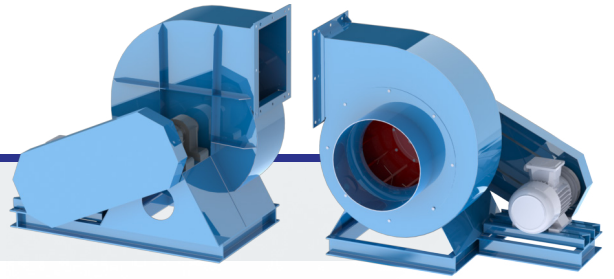

### TEKNİK DEĞERLER / TECHNICAL PARAMETERS

Tip Type	Voltaj Voltage V	Frekans Frequency Hz	Beygir Gücü Horse Power Hp	Güç Power Kw	Devir Speed d/d	Hava Debisi Air Flow m³/h	Basınç Pressure Pa	Fiyat Price		
								Monofaze TL	Trifaze TL	
KKRF-1-4K-M	KKRF-1-4K-T	220/380	50	0,50	0,37	1380	2000	350	5.060,00	4.640,00
KKRF-2-4K-M	KKRF-2-4K-T	220/380	50	1,00	0,75	1410	3750	400	6.280,00	5.840,00
KKRF-3-4K-M	KKRF-3-4K-T	220/380	50	1,50	1,10	1430	4500	450	7.180,00	6.820,00
KKRF-4-4K-M	KKRF-4-4K-T	220/380	50	2,00	1,50	1430	6000	500	9.375,00	9.100,00
KKRF-5-4K-M	KKRF-5-4K-T	220/380	50	3,00	2,20	1435	8500	550	11.660,00	11.180,00
KKRF-6-4K-M	KKRF-6-4K-T	220/380	50	4,00	3,00	1435	10250	600	14.950,00	14.650,00
	KKRF-7-4K-T	380	50	5,50	4,00	1455	12500	650	-	16.700,00
	KKRF-8-4K-T	380	50	7,50	5,50	1465	16500	700	-	19.750,00
	KKRF-9-4K-T	380	50	10,00	7,50	1465	21000	750	-	21.970,00
	KKRF-10-4K-T	380	50	15,00	11,00	1470	25000	850	-	28.379,00
	KKRF-11-4K-T	380	50	20,00	15,00	1470	30000	1000	-	35.776,00
	KKRF-12-4K-T	380	50	25,00	18,50	1475	35000	1100	-	44.408,00
	KKRF-13-4K-T	380	50	30,00	22,00	1475	40000	1200	-	48.900,00

Yön çizelgesi ten arka sayfadadır / The rotations of outlet are shown on the back page

# AKV

## KLASİK SANAYİ TİPİ VANTİLATÖRLER INDUSTRIAL TYPE CLASSIC VENTILATORS



Akrep

Devekuşu

### TEKNİK DEĞERLER / TECHNICAL PARAMETERS

Tip Type	Voltaj Voltage V	Frekans Frequency Hz	Güç Power W	Akım Current d/d	Kondansatör Capacitor (µF/Volt)	Devir Speed d/d	Hava Debisi Air Flow m³/h	Ağırlık Weight Kg	Ambalaj Packing Adet	Fiyat Price TL
AKV-AKREP-4K-M	220	50	300	0,60	7/400	1400	4750	10,80	1	fiyat sorunuz
AKV-DEVEKUŞU-4K-M	220	50	300	0,60	7/400	1400	4750	11,55	1	fiyat sorunuz

# ALV

## SANAYİ TİPİ SALINIMLI LÜKS VANTİLATÖRLER INDUSTRIAL TYPE LUX VENTILATORS



Kelebek

Flamingo

### TEKNİK DEĞERLER / TECHNICAL PARAMETERS

Tip Type	Voltaj Voltage V	Frekans Frequency Hz	Güç Power W	Akım Current d/d	Kondansatör Capacitor (µF/Volt)	Devir Speed d/d	Hava Debisi Air Flow m³/h	Ağırlık Weight Kg	Ambalaj Packing Adet	Fiyat Price TL
ALV-KELEBEK-4K-M	220	50	350	0,60	6/400	1400	5100	11,20	1	fiyat sorunuz
ALV-FLAMİNGO-4K-M	220	50	350	0,60	6/400	1400	5100	12,95	1	fiyat sorunuz

# ASV

## SALINIMLI VE UZAKTAN KUMANDALI VANTİLATÖRLER OSCILLATORY AND REMOTE CONTROL VENTILATORS



Pelikan

Leylek

### TEKNİK DEĞERLER / TECHNICAL PARAMETERS

Tip Type	Voltaj Voltage V	Frekans Frequency Hz	Güç Power W	Devir Speed d/d	Hava Debisi Air Flow m³/h	Ambalaj Packing Adet	Fiyat Price TL
ASV-LEYLEK60-4K-M	220	50	150	1400	11.100	1	fiyat sorunuz
ASV-LEYLEK75-4K-M	220	50	280	1400	17.400	1	fiyat sorunuz
ASV-PELİKAN60-4K-M	220	50	150	1400	11.100	1	fiyat sorunuz
ASV-PELİKAN75-4K-M	220	50	280	1400	17.400	1	fiyat sorunuz

**SOL YÖN (A) / LEFT OUT (A)**

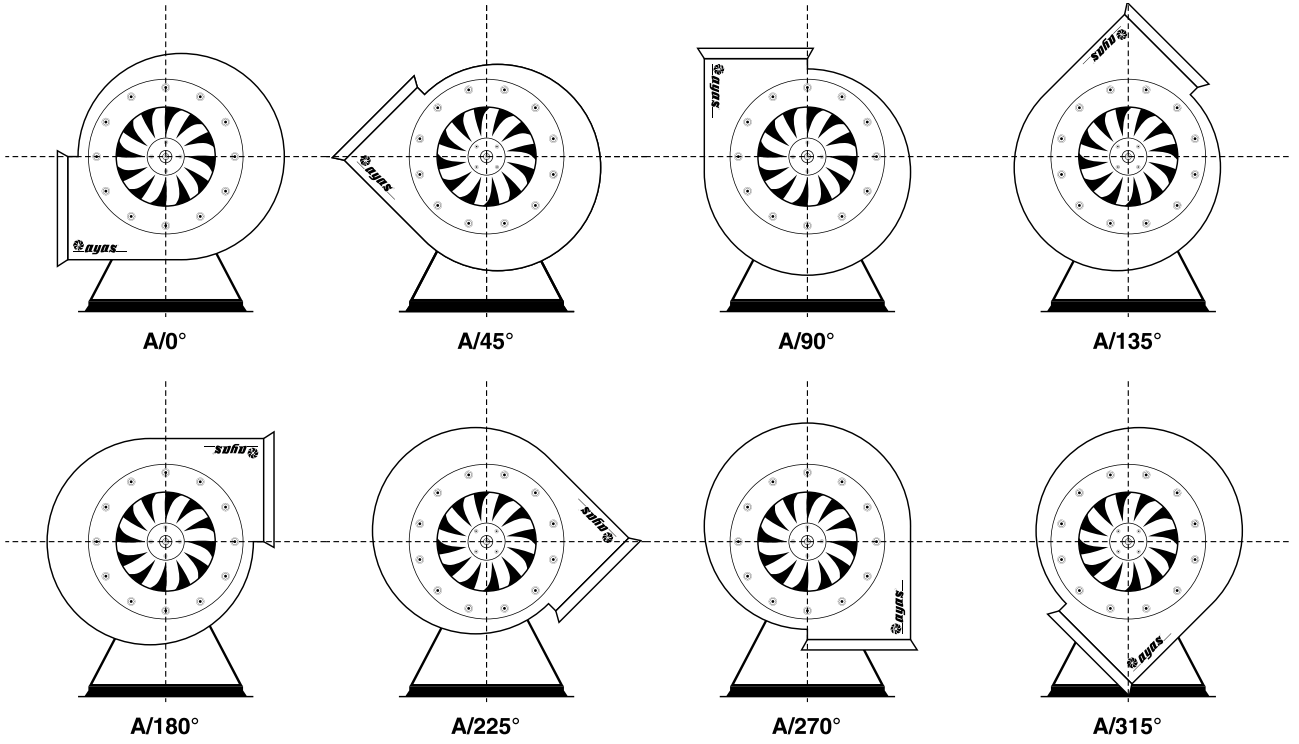

**SAĞ YÖN (B) / RIGHT OUT (B)**

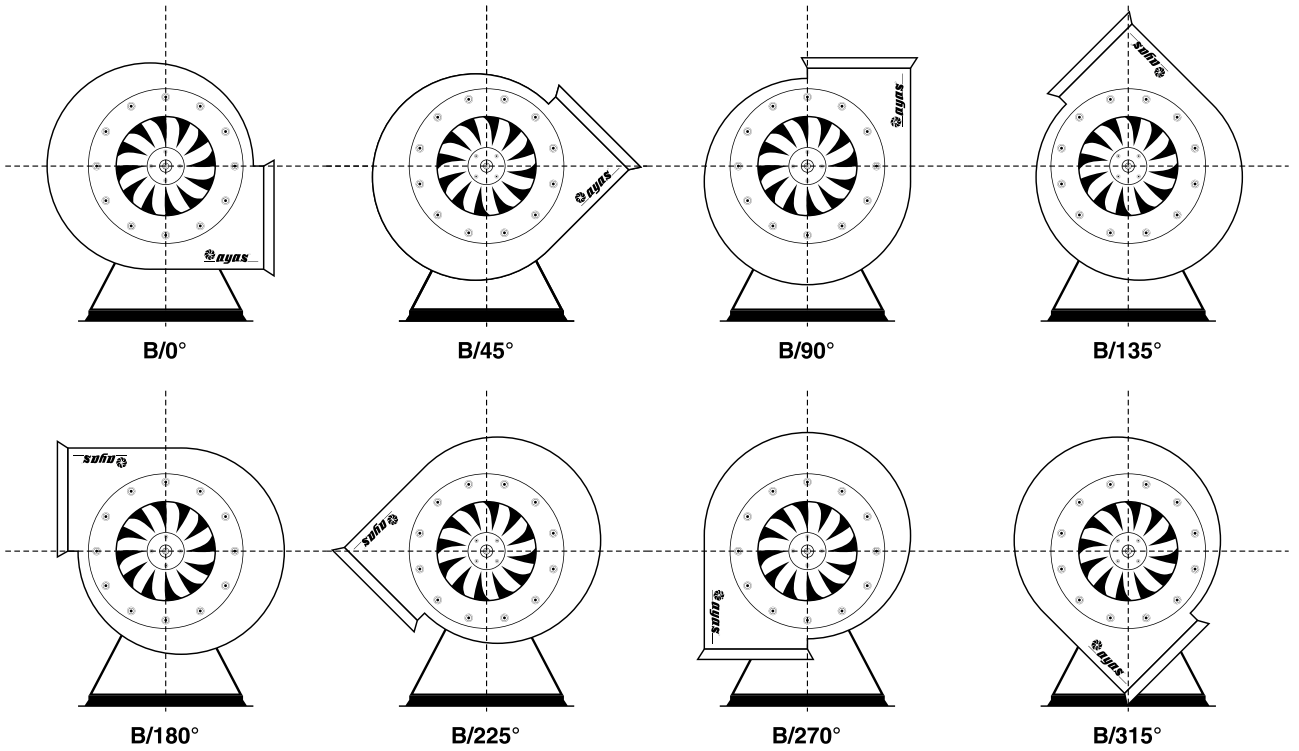

**YÖNLER EMİŞ AĞZINDAN BAKIŞA GÖRE VERİLMİŞTİR / FROM THE VIEW OF INLET**



**AYAS ASPIRATÖR VANTİLATÖR ELEKTRİK MOTORU SANAYİ ve TİC. LTD. ŞTİ.**

Karayolları M. 648. S. No:18/A Gaziosmanpaşa / İSTANBUL  
T. +90 212 612 73 93 F. +90 212 612 73 61  
E-Posta info@ayas.com.tr www.ayas.com.tr



**Türkey**  
Discover  
the potential